



New Jersey 2023 Triennial Technical Reference Manual

For 2024 Filings

New Jersey Board of Utilities

New Jersey's Clean Energy Program™

Draft 4/3/2023

1 TABLE OF CONTENTS

1	INTRODUCTION	9
1.1	PURPOSE	9
1.2	TRM ORGANIZATION	9
1.3	TYPES OF CALCULATIONS	10
1.4	ALGORITHMS	11
1.5	BUILDING ENERGY SIMULATIONS	11
1.6	MEASURE INTERACTIVE SAVINGS	11
1.7	DATA AND INPUT VALUES	11
1.8	BASELINE ESTIMATES	12
1.9	PEAK SAVINGS	13
1.9.1	<i>Electric Coincident Peak Demand</i>	13
1.9.2	<i>Peak Day Natural Gas</i>	14
1.10	OTHER RESOURCES	14
1.11	PROSPECTIVE APPLICATION OF THE TRM	14
1.12	MEASURE COSTS	14
1.13	MEASURE LIVES	14
2	RESIDENTIAL	16
2.1	APPLIANCES	16
2.1.1	<i>Clothes Washer</i>	16
2.1.2	<i>Clothes Dryer</i>	23
2.1.3	<i>Dishwasher</i>	27
2.1.4	<i>Induction Range/Cooktop</i>	31
2.1.5	<i>Refrigerators</i>	34
2.1.6	<i>Freezer</i>	41
2.1.7	<i>Water Cooler</i>	46
2.1.8	<i>Air Purifier</i>	49
2.1.9	<i>Dehumidifier</i>	54
2.1.10	<i>Room Air Conditioner</i>	57
2.2	APPLIANCE RECYCLING	61
2.2.1	<i>Refrigerator & Freezer Recycling</i>	61
2.2.2	<i>Room AC Unit Recycling</i>	64
2.2.3	<i>Dehumidifier Recycling</i>	67
2.3	HVAC	70
2.3.1	<i>Central AC, ASHP, Mini-Splits, PTAC, PTHP</i>	70

2.3.2	<i>Ground Loop and Air-to-Water Heat Pump</i>	77
2.3.3	<i>Furnace and Boiler</i>	85
2.3.4	<i>High Efficiency Bathroom Exhaust Fan</i>	89
2.3.5	<i>EC Motor</i>	91
2.3.6	<i>Duct Sealing and Duct Insulation</i>	95
2.3.7	<i>Heat or Energy Recovery Ventilator</i>	101
2.3.8	<i>Maintenance</i>	108
2.3.9	<i>Boiler Controls</i>	114
2.3.10	<i>Filter Whistle</i>	117
2.3.11	<i>Ceiling Fan</i>	121
2.3.12	<i>Smart Thermostat</i>	126
2.4	LIGHTING	131
2.4.1	<i>Lamps and Fixtures</i>	131
2.4.2	<i>Occupancy Sensor</i>	141
2.5	PLUG LOAD	146
2.5.1	<i>Office Equipment</i>	146
2.5.2	<i>Televisions</i>	149
2.5.3	<i>Smart Strip</i>	153
2.5.4	<i>SoundBar</i>	157
2.5.5	<i>Electric Vehicle Chargers</i>	160
2.6	SHELL	163
2.6.1	<i>Residential/Low-rise Multifamily Air Sealing</i>	163
2.6.2	<i>Insulation</i>	167
2.7	WATER HEATING.....	173
2.7.1	<i>Heat Pump Water Heater</i>	173
2.7.2	<i>Indirect Water Heater</i>	180
2.7.3	<i>Storage Water Heater</i>	184
2.7.4	<i>Tankless Water Heater</i>	188
2.7.5	<i>Water heating Setback</i>	193
2.7.6	<i>Faucet Aerators and Showerheads</i>	197
2.7.7	<i>Thermostatic Showerheads</i>	203
2.7.8	<i>Pipe Insulation</i>	208
2.7.9	<i>Pool Pumps</i>	215
2.8	WHOLE BUILDING	219
2.8.1	<i>Behavioral Change</i>	219
2.8.2	<i>Home Performance with Energy Star (HPwES)</i>	220

2.8.3	<i>New Construction</i>	221
3	COMMERCIAL & INDUSTRIAL.....	223
3.1	AGRICULTURE	223
3.1.1	<i>Auto Milker Takeoff</i>	223
3.1.2	<i>Dairy Pump VFD</i>	226
3.1.3	<i>Dairy Refrigeration Tune Up</i>	230
3.1.4	<i>Dairy Scroll Compressor</i>	233
3.1.5	<i>Livestock Waterer</i>	237
3.1.6	<i>Low Pressure Irrigation</i>	240
3.1.7	<i>Ventilation Fans</i>	244
3.1.8	<i>Heat Reclaimers</i>	249
3.1.9	<i>Engine Block Heater Timer</i>	254
3.2	APPLIANCES.....	257
3.2.1	<i>Clothes Washer</i>	257
3.2.2	<i>Clothes Dryers</i>	263
3.2.3	<i>Clothes Dryer Modulating Valve</i>	267
3.2.4	<i>Refrigerators</i>	270
3.2.5	<i>Freezers</i>	276
3.2.6	<i>Dehumidifier</i>	281
3.2.7	<i>Room Air Conditioner</i>	285
3.2.8	<i>Water Cooler</i>	289
3.3	APPLIANCE RECYCLING	292
3.3.1	<i>Refrigerator & Freezer Recycling</i>	292
3.3.2	<i>Room AC Unit Recycling</i>	295
3.3.3	<i>Dehumidifier Recycling</i>	298
3.4	FOODSERVICE	301
3.4.1	<i>Ovens, Fryer, Steamer & Griddle</i>	301
3.4.2	<i>Holding Cabinets</i>	311
3.4.3	<i>Dishwashers</i>	314
3.4.4	<i>Ice Machines</i>	319
3.5	HVAC	323
3.5.1	<i>Central AC, Air Source Heat Pumps, Mini-Splits, PTAC, pthp</i>	323
3.5.2	<i>Geothermal and Water Source Heat Pumps</i>	330
3.5.3	<i>Infrared Heater</i>	338
3.5.4	<i>Furnaces, Unit Heaters and Boilers</i>	342
3.5.5	<i>Boiler Controls</i>	347

3.5.6	<i>Boiler Economizer</i>	350
3.5.7	<i>Gas Chillers</i>	354
3.5.8	<i>Electric Chillers</i>	357
3.5.9	<i>Make-up Air Unit</i>	361
3.5.10	<i>Heat or Energy Recovery Ventilator</i>	369
3.5.11	<i>Demand Controlled Ventilation</i>	377
3.5.12	<i>Demand Controlled Kitchen Ventilation</i>	383
3.5.13	<i>EC Motors</i>	387
3.5.14	<i>Economizer Controls</i>	391
3.5.15	<i>Guest Room EMS</i>	394
3.5.16	<i>Smart Tstats</i>	398
3.5.17	<i>Maintenance</i>	403
3.5.18	<i>Advanced Rooftop Controls</i>	408
3.6	SHELL	417
3.6.1	<i>High-Rise Multifamily Air Sealing</i>	417
3.7	LIGHTING	421
3.7.1	<i>Lighting Fixtures</i>	421
3.7.2	<i>Lighting Controls</i>	433
3.7.3	<i>Delamping</i>	441
3.7.4	<i>Exit Signs</i>	446
3.7.5	<i>LED Sign Lighting</i>	450
3.7.6	<i>Indoor Horticulture LED</i>	455
3.8	MOTORS AND DRIVES	458
3.8.1	<i>Motors</i>	458
3.8.2	<i>VFD</i>	466
3.9	PLUG LOAD	469
3.9.1	<i>Network Power Management</i>	469
3.9.2	<i>Office Equipment</i>	472
3.9.3	<i>Smart Strip</i>	477
3.9.4	<i>Uninterruptible Power supply</i>	480
3.9.5	<i>Refrigerated Beverage Vending Machine</i>	484
3.9.6	<i>Vending Machine Controls</i>	487
3.9.7	<i>Electric Vehicle Charger</i>	490
3.10	REFRIGERATION.....	492
3.10.1	<i>Energy Efficient Glass Doors on Vertical Open Refrigerated Cases</i>	492
3.10.2	<i>Door Closer</i>	496

3.10.3	<i>Door Gaskets</i>	499
3.10.4	<i>Night Covers</i>	502
3.10.5	<i>Strip Curtains</i>	506
3.10.6	<i>Anti-sweat heat Control</i>	510
3.10.7	<i>Defrost Controls</i>	514
3.10.8	<i>LED Case Lighting</i>	518
3.10.9	<i>Refrigerated Case Light Occupancy Sensors</i>	521
3.10.10	<i>Evaporator Fan EC Motor</i>	524
3.10.11	<i>Evaporator Fan Controller</i>	528
3.10.12	<i>Floating Head Pressure Control</i>	532
3.10.13	<i>VFD Compressor</i>	536
3.11	WATER HEATING.....	539
3.11.1	<i>Storage Water Heater</i>	539
3.11.2	<i>Tankless Water Heater</i>	545
3.11.3	<i>Heat Pump Water Heater</i>	552
3.11.4	<i>Faucet Aerators and Showerheads</i>	560
3.11.5	<i>Combination Boiler</i>	565
3.11.6	<i>Pre-Rinse Spray Valves (PRSV)</i>	571
3.11.7	<i>Recirculating Pump Control</i>	577
3.11.8	<i>Pipe Insulation</i>	585
3.12	PROCESS	592
3.12.1	<i>VSD Air Compressors</i>	593
3.12.2	<i>Compressed Air Leak Detection</i>	596
3.13	WHOLE BUILDING	600
3.13.1	<i>Combined Heat and Power</i>	600
3.13.2	<i>New Construction</i>	606
3.13.3	<i>Operator Training</i>	606
3.13.4	<i>Custom</i>	611
4	APPENDIX A: CLIMATE ZONE DESCRIPTIONS	615
5	APPENDIX B: BUILDING PROTOTYPE DESCRIPTIONS.....	616
5.1	ASSEMBLY	617
5.2	AUTO REPAIR.....	618
5.3	BIG BOX RETAIL	619
5.4	COMMUNITY COLLEGE	621
5.5	DORMITORY	623
5.6	ELEMENTARY SCHOOL.....	624

5.7	FAST FOOD RESTAURANT.....	625
5.8	FULL-SERVICE RESTAURANT	626
5.9	GROCERY	627
5.10	HIGH SCHOOL.....	629
5.11	HOSPITAL	631
5.12	HOTEL	633
5.13	LARGE OFFICE.....	635
5.14	LARGE RETAIL	637
5.15	LIGHT INDUSTRIAL	639
5.16	MOTEL	640
5.17	RELIGIOUS.....	641
5.18	SMALL OFFICE	642
5.19	SMALL RETAIL	643
5.20	UNIVERSITY	644
5.21	WAREHOUSE	646
6	APPENDIX C: HEATING AND COOLING EFLH.....	647
	6.1.1 Residential EFLH.....	647
	6.1.2 C&I Building Types.....	647
	6.1.3 C&I EFLH Values.....	650
7	APPENDIX D: HVAC FAN AND PUMP OPERATING HOURS.....	652
8	APPENDIX E: CODE-COMPLIANT EFFICIENCIES.....	661
8.1	CONVERTING BETWEEN SEER/SEER2, HSPF/HSPF2	661
8.2	HVAC EFFICIENCIES	662
8.3	WATER HEATING EFFICIENCIES.....	664
9	APPENDIX F: HVAC INTERACTIVITY FACTORS	666
10	APPENDIX G: NATURAL GAS PEAK DAY FACTORS	668
10.1	MEASURE LIST	668
10.2	TYPE 1 – DAYS PER YEAR RATIO	674
10.3	TYPE 2 – FULL LOAD HOUR RATIO	675
10.4	TYPE 3 – HEATING DEGREE-DAY RATIO.....	678
10.5	TYPE 4 – HOURS PER YEAR RATIO.....	678
11	APPENDIX H: NET-TO-GROSS FACTORS.....	682
11.1	COMMERCIAL NTG	682
11.2	RESIDENTIAL NTG.....	718
12	APPENDIX I: REALIZATION RATES	766

13	APPENDIX J: IN-SERVICE RATES.....	772
14	APPENDIX K: DHW AND SPACE HEAT FUEL SPLIT	776
15	APPENDIX J: LIGHTING WATTAGES	778
15.1	C&I MIDSTREAM LIGHTING BASELINE WATTAGES.....	778
15.2	FIXTURE WATTAGES BY TYPE.....	783

1 INTRODUCTION

This technical reference manual (TRM) has been developed to calculate resource savings, including electricity, natural gas, and other resource savings from technologies and measures, and to calculate electric energy and capacity savings from renewable energy and distributed generation systems. Specific calculation methods for determination of the resource savings or generation are presented.

These calculations use deemed and customer-specific data as input values to industry-accepted energy and peak demand savings algorithms. The data and input values for the algorithms come from the program application forms or from deemed values. The deemed values are based on the recent impact evaluations or best available secondary research applicable to the New Jersey programs when impact evaluations are not available.

1.1 PURPOSE

The TRM was developed for the purpose of calculating energy and peak demand savings for technologies and measures supported by New Jersey's Clean Energy Program (NJCEP). This includes programs administered by the State of New Jersey through the Board of Public Utilities (BPU), the State's electric and natural gas utilities, or other parties who administer clean energy programs under the guidance of the BPU. The TRM will be updated to reflect the addition of new measures, modifications to existing measures, changes to codes and standards, and the results of evaluation studies. The TRM will be used consistently statewide to assess program impacts and calculate energy and peak demand savings consistent with BPU guidance. The TRM may be used to accomplish the following:

- Report to the BPU on program performance;
- Provide inputs for program planning and cost-effectiveness calculations;
- Provide information to the BPU for calculating Quantitative Performance Indicators (QPI) and applying the Performance Incentive Mechanism (PIM);

Resource savings to be measured include electric energy (kWh) and demand (kW) savings, natural gas savings (therms), peak gas savings (therms/day), and savings of other resources (oil, propane, gasoline, and water) where applicable. In turn, these resource savings will be used to determine avoided environmental emissions and other benefits as described in the New Jersey Cost Test. The TRM is also utilized to support preliminary estimates of the electric energy and capacity from renewable energy and distributed generation systems and the associated environmental benefits.

The calculations in this document focus on the determination of the per unit savings for the energy efficiency measures, and the per unit generation for the renewable energy or distributed generation measures. The BPU has adopted net savings for the purposes of evaluating energy efficiency and peak demand reduction program performance, and performing cost-effectiveness testing. For Triennium 1, the BPU adopted a net-to-gross ratio of 1.0, which should be applied to all programs, including low-income programs. For Triennium 2, net to gross ratios used to calculate net savings are shown in Appendix H: Net-to-Gross Factors and should be applied to the gross savings calculated from this TRM.

1.2 TRM ORGANIZATION

The TRM is organized by customer sector (Residential and Commercial) and by end-use. Within each end-use section, measures are grouped together by end-use subcategory. Note, sector applicability to measures installed multi-family (MF) buildings depends on whether the building is a low rise (3 stories or less) and whether the measure is located in the individual unit or common area. In-unit measures and all measures in MF low-rise buildings are covered in the Residential

section. Measures in common areas of MF high-rise (more than 3 stories) buildings are covered in the Commercial section. Measures used in low-income (LI) or moderate income (MI) programs use the same TRM sections as measures applied to the general population. Any calculations unique to LI or MI programs are identified within each measure section. Measure applied to Agricultural facilities are covered within the Commercial section under the Agricultural end-use.

1.3 TYPES OF CALCULATIONS

The following table summarizes the spectrum of approaches to be used for calculating energy, demand, and resource savings. No one approach will serve all programs and measures. The TRM provides algorithms addressing measure types 1 and 2, and general guidelines for measure type 3.

Table 1-1 Summary of Calculations and Approaches

Type of Measure	Type of Calculation	General Approach	Examples
Deemed prescriptive measures	Standard formula and deemed input values	Number of installed units times deemed savings/unit	Residential appliances
Measures with important variations in one or more input values (e.g., , efficiency level, capacity, load, etc.)	Standard formula with one or more site-specific input values	Standard formula in the TRM with one or more input values coming from the application form, worksheet, or field tool (e.g., , efficiency levels, unit capacity, site-specific load)	Residential Electric HVAC (change in efficiency level times site-specific capacity times standard operating hours); Field screening tools that use site-specific input values
Custom or site-specific measures, or measures in complex comprehensive jobs	Site-specific analysis	Greater degree of site- specific analysis, either in the number of site-specific input values, or in the use of special engineering algorithms, including building simulation programs	Custom Industrial process Complex comprehensive jobs

Several systems work together to ensure accurate data on a given measure:

1. The application form that the customer or customer’s agent submits with basic information.
2. Application worksheets and field tools with more detailed site-specific data, input values, and calculations (for some programs).
3. Program tracking systems that compile data and may do some calculations
4. The TRM that contains algorithms and relies on deemed or site-specific input values. Parts or all of the TRM may ultimately be implemented within the tracking system, the application forms and worksheets, and the field tools.

1.4 ALGORITHMS

The TRM presents a set of engineering algorithms to calculate energy and demand savings. Savings are generally driven by a change in efficiency level for the installed measure compared to a baseline level of efficiency. Energy savings are calculated from the change in efficiency and/or the change the annual operating hours of equipment. Operating hours may be expressed as run hours for constant output devices or equivalent full load hours (EFLH) for equipment that operates at varying levels of output throughout the year. Energy and demand savings may be calculated for both electricity and natural gas regardless of the targeted fuel.

1.5 BUILDING ENERGY SIMULATIONS

When building energy simulation software is used to develop savings estimates for several measures in a comprehensive project, the specific algorithms used are inherent in the software and account for interaction among measures by design. Building simulation software used for any program must be compliant with one of the following:

- A software tool addressing residential and/or commercial buildings whose performance has passed testing according to the National Renewable Energy Laboratory's BESTEST software or ASHRAE Standard 140 energy simulation testing protocol,
- Software approved the US Department of Energy's Weatherization Assistance program, or
- RESNET approved home energy rating software (HERS).

1.6 MEASURE INTERACTIVE SAVINGS

Throughout the TRM, the interactive effect of thermostatically-sensitive building components is accounted for in specific measure sections, as appropriate. In instances where there is a measurable amount of interaction between two energy consuming sources, the energy or peak demand savings are accounted for in either the algorithms or in the modeling software used to determine energy savings.

For example, in a measure section where the lighting load has a direct effect on the energy used to condition the space, the TRM provides an interactive effect value to be used in the savings algorithm for certain measures. Other measures rely on the characteristics of the modeling software that account for the effect within a building, such as a new construction protocol software that will apply the effects for a measurable difference in the baseline and efficient buildings.

Measure savings calculation based on simple engineering algorithms are not designed to account for the interactive effects of multiple measures installed in a building. When multiple measures are installed, it is acceptable to sum the individual measure savings. Energy savings calculations based on building energy simulations account for multiple measure interactions by design.

1.7 DATA AND INPUT VALUES

Some input values, including site-specific data, will come directly from the program application forms, worksheets, and field tools. Site-specific data on the application forms are used for measures with important variations in one or more input values (efficiency level, capacity, etc.).

Standard input values are based on the best available measured or industry data, including metered data, measured data from prior evaluations (applied prospectively), field data and program results, nameplate data, in situ values, and/or standards from industry associations.

For the deemed input assumptions where metered or measured data were not available, the input values (e.g., watts, efficiency, equipment capacity, operating hours, coincidence factors) are based on the best available industry data or standards. These input values were based on a review of literature from related evaluation studies and information from various industry organizations, equipment manufacturers, and suppliers. For custom projects, measurement and verification (M&V) options are presented that use pre- and/or post-retrofit measurements of energy consumption or equipment performance to estimate energy savings.

1.8 BASELINE ESTIMATES

For measures in which the existing equipment has failed, is at the end of its useful life, or the program administrator does not have knowledge of the state of the existing equipment, the resource savings values are based difference between the energy use of new products that meet code or represent industry standard practice vs. the high efficiency products promoted through the programs. For early replacement of functioning equipment, energy and demand savings values are based on the difference between high efficiency equipment versus existing equipment. A dual baseline approach must be followed, where the savings relative to the existing equipment baseline are used for the remaining useful life of the existing equipment and a code or standard practice baseline is used for the remaining life of the measure. In lieu of the dual baseline approach, lighting measures may use an adjusted measure life (AML) to account for early replacement of functioning systems and differences in the lifetimes of efficient vs. standard practice equipment. The AML is defined as the lifetime energy savings considering a dual baseline divided by first year savings.

Measures in the TRM are categorized according to the following baseline condition definitions:

Baseline Condition	Attributes
Time of Sale (TOS)	<p>Definition: A program in which the customer is incented to purchase or install higher efficiency equipment than if the program had not existed. This may include retail rebate (coupon) programs, upstream buydown programs, online store programs, contractor based programs, or giveaways as examples. May include replacement of existing equipment at the end of its life (i.e., replace on burnout) or purchase of new equipment. In cases where a new construction characterization isn't explicitly provided, the TOS characterization is typically appropriate.</p> <p>Baseline: New standard efficiency, code compliant, or industry standard practice equipment.</p> <p>Efficient Case: New, premium efficiency equipment above federal and state codes and standards and industry standard practice.</p> <p>Example: Appliance rebate</p>
New Construction (NC)	<p>Definition: A program that intervenes during building design, expansion, or gut rehabilitation to support the use of more-efficient equipment and construction practices.</p> <p>Baseline: Building code, federal standards, or industry standard practice.</p> <p>Efficient Case: The program's level of building specification</p> <p>Example: Building shell and mechanical measures</p>

Baseline Condition	Attributes
Retrofit (RF)	<p>Definition: A program that upgrades or enhances existing equipment.</p> <p>Baseline: Existing equipment or the existing condition of the building or equipment. A single baseline applies over the measure’s life. When a measure is applied to existing operational equipment and the measure benefit will cease upon the end of the underlying equipment’s life, the measure life is the smaller of the host equipment remaining life or the full measure life.</p> <p>Efficient Case: Post-retrofit efficiency of equipment.</p> <p>Example: Air sealing, insulation, controls</p>
Early Replacement (EREP)	<p>Definition: A program that replaces existing, operational equipment.</p> <p>Baseline: Dual. It begins as the existing equipment and shifts to projected TOS baseline equipment after the remaining life of the existing equipment is over.</p> <p>Efficient Case: New, premium efficiency equipment above federal and state codes and industry standard practice.</p> <p>Example: Refrigerators and freezers; early replacement of HVAC equipment.</p> <p><i>Note: For lighting measures, the adjusted measure life (AML) may be used in lieu of a dual baseline approach.</i></p>
Early Retirement (ERET)	<p>Definition: A program that retires inefficient, operational duplicative equipment or inefficient equipment that might otherwise be resold. No new equipment is installed in place of the old equipment, and no existing equipment use increases to compensate for the retirement.</p> <p>Baseline: The existing equipment, which is retired and not replaced.</p> <p>Efficient Case: Assumes zero consumption since the unit is retired.</p> <p>Example: Appliance recycling, delamping.</p>
Direct Install (DI)	<p>Definition: A program where measures are installed during a site visit and are assumed to replace existing, operational equipment.</p> <p>Baseline: Same as EREP.</p> <p>Efficient Case: Same as EREP.</p> <p>Example: Lighting and low-flow hot water measures</p> <p><i>Note: For lighting measures, the adjusted measure life (AML) may be used in lieu of a dual baseline approach.</i></p>

1.9 PEAK SAVINGS

1.9.1 ELECTRIC COINCIDENT PEAK DEMAND

System peak demand refers to the highest amount of electricity consumed during a single hour across PJM. Peak coincident demand is the demand of a measure that occurs at the same time as the PJM system peak. PJM system peak typically occurs on a weekday during the months of June, July or August, during the hour that ends at 16:00 and 19:00

Eastern Prevailing Time. Therefore peak coincident demand savings should be calculated based on the average demand reduction during the hours in that time frame.¹

1.9.2 PEAK DAY NATURAL GAS

Calculations have been developed to determine the natural gas energy savings on an annual and peak day basis. Additional calculations done as part of the cost effectiveness calculations allocate the annual savings on a seasonal basis. Peak gas savings are calculated on a therm/day basis, using peak day heating degree-days representing the weather conditions under which the natural gas distribution system reaches peak capacity. Design day conditions from the London Economics study are used to calculate peak gas savings:

Condition	Average Heating Degree days base 65 (°F – day)	Average Daily Temperature (°F)
Winter Design Day	66.4	-1.4

1.10 OTHER RESOURCES

Measures that save electricity or natural gas may also affect the use of other fuels, water or other costs, and will affect emissions. The New Jersey Cost Test accounts for emissions reductions associated with electricity and natural gas and the net direct and indirect economic benefit of these other factors. The NJCT-required outputs from TRM use are natural gas and electric energy and electric summer peak demand gross impact.

1.11 PROSPECTIVE APPLICATION OF THE TRM

The TRM will be updated annually based on evaluation results and available data, and then applied prospectively for future program years in accordance with applicable BPU direction. Prospective application of the TRM will include calculation of gross energy and demand savings from the applicable measure section modified by evaluation-derived in-service rates as presented in Appendix J: In-Service Rates, realization rates as presented in Appendix I: Realization Rates and net to gross ratios as presented in Appendix H: Net-to-Gross Factors.

1.12 MEASURE COSTS

Measure costs for use in cost-effectiveness calculations are presented in a separate document. Projects will use incremental costs and/or full measure costs depending on the baseline condition. Consult the measure cost document for information on how to calculate measure costs.

1.13 MEASURE LIVES

Measure effective useful life (EUL) is provided in each TRM measure section for the purpose of calculating lifetime energy savings. Projects utilizing a dual baseline approach will rely on a combination of the existing equipment remaining useful life (RUL) and the new equipment EUL. Calculations of lifetime savings for retrofit projects involving add-on equipment

¹ Coincidence factors provided in the TRM measure sections are based on best available information. These coincidence factors may not conform to PJM requirements for bidding into the forward capacity market.

such as controls will use the smaller of the measure EUL and the host equipment RUL. Measures where values for adjusted measure life (AML) are provided will use the AML in lieu of a dual baseline approach.

2 RESIDENTIAL

2.1 APPLIANCES

2.1.1 CLOTHES WASHER

Market	Residential/Multifamily
Baseline Condition	TOS
Baseline	Code
End Use Subcategory	Clothes Washer
Measure Last Reviewed	January 2023

Description

This measure is for a new or replacement ENERGY STAR or ENERGY STAR Most Efficient residential clothes washer in single family or multifamily homes. Please note that common area laundry rooms in Multifamily buildings should follow the C&I methodology.

ENERGY STAR® clothes washers have a higher Integrated Modified Energy Factor (IMEF) and a lower Integrated Water Factor (IWF), saving energy and water with greater tub capacities and sophisticated wash and rinse systems. Rather than filling the tub with water, efficient wash cycles are achieved by spinning or flipping clothes through a stream of water. Efficient rinse cycles are achieved through high-pressure spraying instead of soaking clothes. Reduced dryer load represents additional energy savings associated with the thorough removal of water from the clothes in the washer.

Baseline Case

The baseline for energy savings calculations is a clothes washer meeting the federal minimum Integrated Modified Energy Factor (IMEF) and not exceeding the federal maximum Integrated Water Factor (IWF), as defined in 10 CFR 430.32(f)(2). The IMEF and IWF are determined by clothes washer configuration (top-load or front-load) and capacity. Energy usage includes the washer and dryer energy consumption and water heating energy usage.

Efficient Case

The energy consumption of the efficient equipment is calculated based on the IMEF and IWF of the ENERGY STAR version 8.1 specification or ENERGY STAR Most Efficient product and other variables as defined in the calculation methodology below.

Annual Energy Savings Algorithms

Annual Electric Energy Savings

$$\Delta kWh = \Delta kWh_{washer} + \Delta kWh_{DHW} + \Delta kWh_{dryer}$$

Where,

$$\Delta kWh_{washer} = Cap \times \left(\frac{F_{washer,b}}{IMEF_b} - \frac{F_{washer,q}}{IMEF_q} \right) \times N_{cycles}$$

$$\Delta kWh_{DHW} = Cap \times \left(\frac{F_{DHW,b}}{IMEF_b} - \frac{F_{DHW,q}}{IMEF_q} \right) \times N_{cycles} \times SF_{DHW,electric}$$

$$\Delta kWh_{dryer} = Cap \times \left(\frac{F_{dryer,b}}{IMEF_b} - \frac{F_{dryer,q}}{IMEF_q} \right) \times N_{cycles} \times SF_{dryer,electric}$$

Annual Fuel Savings

$$\Delta Therms = \Delta Therms_{DHW} + \Delta Therms_{dryer}$$

Where,

$$\Delta Therms_{DHW} = Cap \times \left(\frac{F_{DHW,b}}{IMEF_b} - \frac{F_{DHW,q}}{IMEF_q} \right) \times N_{cycles} \times R_q \times SF_{DHW,ff} \times 0.03412$$

$$\Delta Therms_{dryer} = Cap \times \left(\frac{F_{dryer,b}}{IMEF_b} - \frac{F_{dryer,q}}{IMEF_q} \right) \times N_{cycles} \times SF_{dryer,ff} \times 0.03412$$

Peak Demand Savings

$$\Delta kW_{peak} = \frac{\Delta kWh}{Hrs} \times CF$$

Daily Peak Fuel Savings

$$\Delta Therms_{Peak} = \Delta Therms \times PDF$$

Lifetime Energy Savings Algorithms

Lifetime Electric Energy Savings

$$\Delta kWh_{Life} = \Delta kWh \times EUL$$

Lifetime Fuel Savings

$$\Delta Therms_{Life} = \Delta Therms \times EUL$$

Calculation Parameters

Table 2-1 Calculation Parameters

Variable	Description	Value	Units	Ref
ΔkWh	Annual electric energy savings	Calculated	kWh/yr	
$\Delta kWh_{\text{washer}}$	Annual electric energy savings attributed to clothes washer operation	Calculated	kWh/yr	
ΔkWh_{DHW}	Annual electric energy savings attributed to water heating	Calculated	kWh/yr	
$\Delta kWh_{\text{dryer}}$	Annual electric energy savings attributed to dryer operation	Calculated	kWh/yr	
ΔTherms	Annual fuel savings	Calculated	Therms/yr	
$\Delta \text{Therms}_{\text{DHW}}$	Annual fuel savings attributed to water heating	Calculated	Therms/yr	
$\Delta \text{Therms}_{\text{dryer}}$	Annual fuel savings attributed to dryer operation	Calculated	Therms/yr	
ΔkW_{Peak}	Peak Demand Savings	Calculated	kW	
$\Delta \text{Therms}_{\text{Peak}}$	Daily peak fuel savings	Calculated	Therms/day	
ΔkWh_{Life}	Lifetime electric energy savings	Calculated	kWh	
$\Delta \text{Therms}_{\text{Life}}$	Lifetime fuel savings	Calculated	Therms	
ΔH_2O	Annual water savings	Calculated	Gal/yr	
Cap	Capacity of clothes washer	Site-specific. If unknown, use 3.39	ft ³	[1]
$IMEF_q$	Integrated Modified Energy Factor of efficient unit	Site-specific. If unknown, look up in Table 2-3	ft ³ /(kWh·cycle)	[2][3]
IWF_q	Integrated water factor for efficient unit	Site-specific. If unknown, look up in Table 2-8	Gal/(cycle·ft ³)	[2][3]
$IMEF_b$	Integrated Modified Energy Factor of baseline unit	Look up in Table 2-2	ft ³ /(kWh·cycle)	[2]
N_{cycles}	Number of clothes washer cycles per year	Look up in Table 2-4	cycles	
$F_{\text{washer},b}$	Fraction of total energy consumption attributed to clothes washer operation for the baseline case	Look up in Table 2-5	N/A	[5]
$F_{\text{washer},q}$	Fraction of total energy consumption attributed to clothes washer operation for the efficient case	Look up in Table 2-6	N/A	[6]
$F_{\text{DHW},b}$	Fraction of total energy consumption attributed to water heating for the baseline case	Look up in Table 2-5	N/A	[5]

Variable	Description	Value	Units	Ref
$F_{DHW,q}$	Fraction of total energy consumption attributed to water heating for the efficient case	Look up in Table 2-6	N/A	[6]
$F_{dryer,b}$	Fraction of total energy consumption attributed to dryer operation for the baseline case	Look up in Table 2-5	N/A	[5]
$F_{dryer,q}$	Fraction of total energy consumption attributed to dryer operation for the efficient case	Look up in Table 2-6	N/A	[6]
$SF_{DHW,electric}$	Electric DHW savings factor	Look up in Table 2-7	N/A	[10]
$SF_{dryer,electric}$	Electric dryer savings factor	Look up in Table 2-7	N/A	[10]
$SF_{DHW,ff}$	Fossil fuel DHW savings factor	Look up in Table 2-7	N/A	[10]
$SF_{dryer,ff}$	Fossil fuel dryer savings factor	Look up in Table 2-7	N/A	[10]
Hrs	Annual operating hours	Look up in Table 2-4	Hrs/yr	
IWF_b	Integrated water factor for baseline unit	Look up in Table 2-2	Gal/(cycle·ft ³)	
CF	Electric coincidence factor	Look up in Table 2-9	N/A	
PDF	Gas peak day factor	Look up in Table 2-9	N/A	
R_q	Recovery efficiency factor	1.26	N/A	[8]
0.03412	Unit conversion, therm/kWh	0.03412	Therm/kWh	
EUL	Effective useful life	See Measure Life Section	Years	

Table 2-2 Federal Standard Minimum IMEF and Maximum IWF

Configuration	Capacity (ft ³)	IMEF	IWF
Top Load	<1.6	1.15	12.0
Top Load	≥1.6	1.57	6.5
Front Load	<1.6	1.13	8.3
Front Load	≥1.6	1.84	4.7

Table 2-3 Efficient Unit Minimum IMEF

Efficiency Level	Front Loading	Top Loading
Clothes Washers > 2.5 ft ³		
ENERGY STAR	2.76	2.06
CEE Tier 1	2.76	2.76
CEE Tier 2	2.92	

Efficiency Level	Front Loading	Top Loading
CEE Tier 3	3.10	
Clothes Washers $\leq 2.5 \text{ ft}^3$		
ENERGY STAR	2.07	
CEE Tier 1	2.07	
CEE Tier 2	2.20	

Table 2-4 Annual Cycles and Hours

Type	Number of Cycles	Annual Hours	Ref
Single Family	254	295	[4]

Table 2-5 Total Energy Consumption Breakdown for Baseline Case

Efficiency Level	Clothes Washer (F_{washer})	DHW (F_{DHW})	Dryer (F_{dryer})
Federal Standard	0.07	0.65	0.28

Table 2-6 Total Energy Consumption Breakdown for Efficient Case

Efficiency Level	Clothes Washer (F_{washer})	DHW (F_{DHW})	Dryer (F_{dryer})
Clothes Washers ($> 2.5 \text{ ft}^3$)			
ENERGY STAR	0.05	0.63	0.32
CEE Tier 1	0.05	0.63	0.32
CEE Tier 2	0.10	0.87	0.03
CEE Tier 3	0.10	0.87	0.03
Clothes Washers ($\leq 2.5 \text{ ft}^3$)			
CEE Tier 1	0.08	0.72	0.20
CEE Tier 2	0.08	0.72	0.20

Table 2-7 DHW and Dryer Savings Factors

Fuel	$SF_{\text{DHW,electric}}$	$SF_{\text{dryer,electric}}$	$SF_{\text{DHW,ff}}$	$SF_{\text{dryer,ff}}$
Electric	1.00	1.00	0	0
Fossil Fuel	0	0	1.00	1.00
Unknown	0.31	0.68	0.69	0.32

Table 2-8 Efficient Unit Maximum IWF

Efficiency Level	Front Loading	Top Loading
Standard Sized Clothes Washers (> 2.5 ft ³)		
ENERGY STAR	3.2	4.3
CEE Tier 1	3.2	3.2
CEE Tier 2	3.2	3.2
CEE Tier 3	3.0	3.0
Small Sized Clothes Washers (≤ 2.5 ft ³)		
ENERGY STAR		4.2
CEE Tier 1		4.2
CEE Tier 2		3.7

Peak Factors**Table 2-9 Peak Factors**

Peak Factor	Value	Ref
Electric coincidence factor (CF)	0.029	[7]
Natural gas peak day factor (PDF)	See Appendix G: Natural Gas Peak Day Factors	

Non-Energy Impacts

$$\Delta H_{2O} = (IWF_b - IWF_q) \times Cap \times N_{cycles}$$

Measure Life

The effective useful life (EUL) is 14 years. [9]

References

- [1] Based on the average clothes washer volume of all units that are ENERGY STAR qualified as of 3/17/2020.
- [2] 10 CFR Subpart C of Part 430. <https://www.ecfr.gov/current/title-10/chapter-II/subchapter-D/part-430/subpart-C/section-430.32>
- [3] ENERGY STAR Program Requirements Product Specification for Clothes Washers, Version 8.1. 2021. <https://www.energystar.gov/sites/default/files/asset/document/ENERGY%20STAR%20Version%208.1%20Clothes%20Washer%20Final%20Specifaciton%20-%20Partner%20Commitments%20and%20Eligibility%20Criteria.pdf>

- [4] CEE, Residential Clothes Washer Specification (2022). https://library.cee1.org/system/files/library/12282/CEE_ClothesWasher_Specification_17May2022.pdf
- [5] 10 CFR Subpart B of Part 430. <https://www.ecfr.gov/current/title-10/chapter-II/subchapter-D/part-430/subpart-B>
- [6] The percentage of total energy consumption that is used for the machine, heating the hot water or by the dryer is different depending on the efficiency of the unit. Values are based on a weighted average of top loading and front loading units (based on available product from the ENERGY STAR qualified product list accessed on 3/17/2020) and consumption data from Life-Cycle Cost and Payback Period Excel-based analytical tool, available online at: <https://www.regulations.gov/docketBrowser?rpp=25&so=DESC&sb=commentDueDate&po=0&dct=SR&D=EERE2008-BT-STD-0019>
- [7] Navigant, EmPOWER Maryland DRAFT Final Impact Evaluation Report Evaluation Year 4 (June 1, 2012 – May 31, 2013) Commercial & Industrial Prescriptive & Small Business Programs (2013).
- [8] To account for the different efficiency of electric and fossil fuel water heaters (gas water heater: recovery efficiencies ranging from 0.74 to 0.85 (0.78 used), and electric water heater with 0.98 recovery efficiency (http://www.energystar.gov/ia/partners/bldrs_lenders_raters/downloads/Waste_Water_Heat_Recovery_Guidelines.pdf). Therefore, a factor of 0.98/0.78 (1.26) is applied.
- [9] Regulations.gov, Residential Clothes Washers Life-Cycle Cost Analysis (LCC) Spreadsheets (2021). <https://www.regulations.gov/document/EERE-2017-BT-STD-0014-0025>
- [10] U.S. EIA 2015 Residential Energy Consumption Survey. <https://www.eia.gov/consumption/residential/data/2015/>

2.1.2 CLOTHES DRYER

Market	Residential/Multifamily/Low Income
Baseline Condition	TOS
Baseline	Code
End Use Subcategory	Clothes Washer
Measure Last Reviewed	December 2022

Description

This measure is for a new or replacement ENERGY STAR or ENERGY STAR Most Efficient residential clothes dryer. This measure relates to the installation of a residential clothes dryer meeting the ENERGY STAR V1.1 criteria. ENERGY STAR qualified clothes dryers save energy through a combination of more efficient drying and reduced runtime of the drying cycle. More efficient drying is achieved through increased insulation, modifying operating conditions such as air flow and/or heat input rate, improving air circulation through better drum design or booster fans, and improving efficiency of motors. Reducing the runtime of dryers through automatic termination by temperature and moisture sensors is believed to have the greatest potential for reducing energy use in clothes dryers. ENERGY STAR provides criteria for both gas and electric clothes dryers.

This measure can also be used for small commercial and industrial applications.

Baseline Case

The baseline for energy savings calculations is a clothes dryer meeting the federal minimum combined energy factor for machines manufactured after January 2015. The minimum combined energy factor varies by clothes dryer type.

Efficient Case

The energy consumption of the efficient equipment is calculated based on the combined energy factor of the ENERGY STAR or ENERGY STAR Most Efficient product and other variables defined in the calculation methodology.

Annual Energy Savings Algorithm

Annual Electric Energy Savings

$$\Delta kWh = Cycles_{annual} \times Load \times \left(\frac{F_{elec,b}}{CEF_b} - \frac{F_{elec,q}}{CEF_q} \right)$$

Annual Fuel Savings

$$\Delta Therms = Cycles_{annual} \times Load \times \left(\frac{F_{fuel,b}}{CEF_b} - \frac{F_{fuel,q}}{CEF_q} \right) \times \frac{3,412}{100,000}$$

Peak Demand Savings

$$\Delta kW_{Peak} = \frac{\Delta kWh}{Hrs} \times CF$$

Daily Peak Fuel Savings

$$\Delta Therms_{Peak} = \Delta Therms \times PDF$$

Lifetime Energy Savings Algorithms:

Lifetime Electric Energy Savings

$$\Delta kWh_{Life} = \Delta kWh \times EUL$$

Lifetime Fuel Savings

$$\Delta Therms_{Life} = \Delta Therms \times EUL$$

Calculation Parameters

Table 2-10 Calculation Parameters

Variable	Description	Value	Units	Ref
ΔkWh	Annual electric energy savings	Calculated	kWh/yr	
$\Delta Therms$	Annual fuel savings	Calculated	Therms/yr	
ΔkW_{Peak}	Peak Demand Savings	Calculated	kW	
$\Delta Therms_{Peak}$	Daily peak fuel savings	Calculated	Therms/day	
ΔkWh_{Life}	Lifetime electric energy savings	Calculated	kWh	
$\Delta Therms_{Life}$	Lifetime fuel savings	Calculated	Therms	
$Cycles_{Annual}$	Number of dryer cycles per year	Site-specific. If unknown, use 283	Cycles	[14]
Hrs	Annual run hours of clothes dryer	Site-specific. If unknown, use 290 ²	Hrs/yr	[14][16]
Load	Average total weight of clothes per drying cycle	Look up in Table 2-11	lbs	[14]
$F_{elec,b}$	Percentage of energy consumed that is derived from electricity for baseline condition	Look up in Table 2-11	N/A	[15][16]
CEF_b	Combined energy factor for baseline condition	Look up in Table 2-11	lb/kWh	[13]
$F_{elec,q}$	Percentage of energy consumed that is derived from electricity for efficient condition	Look up in Table 2-11	N/A	[15][16]

² Assumes average of 56 minutes per cycle based on Ecova, 'Dryer Field Study', Northwest Energy Efficiency Alliance (NEEA) 2014.

Variable	Description	Value	Units	Ref
CEF _q	Combined energy factor for efficient case	Site-specific. If unknown, look up in Table 2-11	lb/kWh	[12]
F _{fuel,b}	Percentage of energy consumed that is derived from fossil fuel for baseline condition	Look up in Table 2-11	N/A	[15][16]
F _{fuel,q}	Percentage of energy consumed that is derived from fossil fuel for efficient case	Look up in Table 2-11	N/A	[15][16]
CF	Electric coincidence factor	Look up in Table 2-12	N/A	[15]
PDF	Gas peak demand factor	Look up in Table 2-12	N/A	
3,412	Conversion factor from kWh to Btu	3,412	Btu/kWh	
100,000	Conversion factor from Btu to therms	100,000	Btu/Therm	
EUL	Effective useful life	See Measure Life Section	Years	

Table 2-11 Default Values for Various Dryer Types

Dryer Type	Load	F _{elec,b}	F _{elec,q}	F _{fuel,b}	F _{fuel,q}	CEF _b	CEF _q (Energy Star)	CEF _q (Energy Star Most Efficient)
Vented Gas Dryer	8.45	0.16 ³	0.16	0.84 ⁴	0.84	3.30	3.48	
Ventless or Vented Electric, Standard ≥ 4.4 ft ³	8.45	1.00	1.00	0.00	0.00	3.73	3.93	4.3
Ventless or Vented Electric, Compact (120V) < 4.4 ft ³	3.00	1.00	1.00	0.00	0.00	3.61	3.80	4.3
Vented Electric, Compact (240V) < 4.4 ft ³	3.00	1.00	1.00	0.00	0.00	3.27	3.45	4.3
Ventless Electric, Compact (240V) < 4.4 ft ³	3.00	1.00	1.00	0.00	0.00	2.55	2.68	3.7

Peak Factors

Table 2-12 Peak Factors

Peak Factor	Value	Ref
Electric coincidence factor (CF)	0.029	[17]

³ %Electric accounts for the fact that some of the savings on gas dryers comes from electricity (motors, controls, etc). 16% was determined using a ratio of the electric to total savings from gas dryers given by ENERGY STAR Draft 2 Version 1.0 Clothes Dryers Data and Analysis.

⁴ %Gas accounts for the fact that some of the savings on gas dryers comes from electricity (motors, controls, etc). 84% was determined using a ratio of the gas to total savings from gas dryers given by ENERGY STAR Draft 2 Version 1.0 Clothes Dryers Data and Analysis.

Peak Factor	Value	Ref
Natural gas peak day factor (PDF)	See Appendix G: Natural Gas Peak Day Factors	

Measure Life

The effective useful life (EUL) is 12 years [11].

References

- [11] California Public Utilities Commission Database for Energy Efficient Resources (DEER) EUL Support Table for 2020.
- [12] ENERGY STAR Program Requirements for Clothes Dryers. n.d. Accessed December 27, 2022.
https://www.energystar.gov/sites/default/files/ENERGY%20STAR%20Final%20Version%201.1%20Clothes%20Dryers%20Specification%20-%20Program%20Commitment%20Criteria%20and%20Eligibility%20Criteria_0.pdf
- [13] PART 430 - ENERGY CONSERVATION PROGRAM FOR CONSUMER PRODUCTS n.d. <https://federalregister.gov>.
<https://www.ecfr.gov/current/title-10/chapter-II/subchapter-D/part-430#430.32>
- [14] *Savings Calculator for ENERGY STAR Qualified Appliances*, ENERGY STAR, 2012.
https://www.sfwmd.gov/sites/default/files/documents/calculator_energy_star_res_appliance_savings.xlsx
- [15] *Mid-Atlantic Technical Reference Manual (TRM) V10*. (2020). <https://neep.org/sites/default/files/media-files/trmv10.pdf>
- [16] ENERGY STAR Draft 2 Version 1.0 Clothes Dryers Data and Analysis, August 2013.
<https://www.energystar.gov/sites/default/files/specs/ENERGY%20STAR%20Draft%202%20Version%201.0%20Clothes%20Dryers%20Data%20and%20Analysis.xlsx>
- [17] Northwest Energy Efficiency Alliance (NEEA), *Dryer Field Study*, November 2014. https://ecotope-publications-database.ecotope.com/2014_005_1_DryerStudy.pdf

2.1.3 DISHWASHER

Market	Residential/Multifamily/Low Income
Baseline Condition	NC/TOS
Baseline	Code
End Use Subcategory	Kitchen
Measure Last Reviewed	December 2022

Description

This measure covers the installation of ENERGY STAR® V6.0 qualified residential dishwashers. A dishwasher is a cabinet-like appliance that, with the aid of water and detergent, washes, rinses, and dries (when a drying process is included) dishware, glassware, eating utensils, and most cooking utensils by chemical, plumbing, and/or electrical means and discharges to the plumbing drainage system. ENERGY STAR® rated machines run more efficiently while washing dishes through improved technology such as soil sensors, improved water filtration, more efficient jets, and innovative dish rack designs. Qualified dishwashers are at least 8.6% more efficient than non-certified models.

Baseline Case

The baseline condition is a residential dishwasher as defined in the Measure Description section above with type equivalent to the efficient case meeting the minimum effective federal performance standards. The baseline water heating system is a standard efficiency storage type electric or fossil fuel system (fuel type equivalent to the actual existing condition). Current federal annual energy consumption performance standards for dishwashers are provided in the table below.

Efficient Case

The compliance condition is an ENERGY STAR® V6.0 qualified residential dishwasher as defined in the Measure Description section above. Qualifying equipment must have rated annual energy consumption at or below the ENERGY STAR® qualified specifications as indicated the table below, based on dishwasher type. The energy consumption rating of the qualified dishwasher is to be taken from the application.

Annual Energy Savings Algorithms

Annual Electric Energy Savings

$$\Delta kWh = (kWh_b - kWh_q) \times (F_{machine} + F_{wh} \times ElecSF_{wh})$$

Annual Fuel Savings

$$\Delta Therms = (kWh_b - kWh_q) \times F_{wh} \times FuelSF_{wh} \times 1.307 \times \frac{3,412}{100,000}$$

Summer Peak Coincident Demand Savings

$$\Delta kW_{Peak} = \frac{\Delta kWh}{hrs} \times CF$$

Daily Peak Fuel Savings

$$\Delta Therms_{Peak} = \Delta Therms \times PDF$$

Lifetime Energy Savings Algorithms

Lifetime Electric Energy Savings

$$\Delta kWh_{Life} = \Delta kWh \times EUL$$

Lifetime Fuel Savings

$$\Delta Therms_{Life} = \Delta Therms \times EUL$$

Calculation Parameters

Table 2-13 Calculation Parameters

Variable	Description	Value	Units	Ref
ΔkWh	Annual electric energy savings	Calculated	kWh/yr	
$\Delta Therms$	Annual fuel savings	Calculated	Therms/yr	
ΔkW_{Peak}	Peak Demand Savings	Calculated	kW	
$\Delta Therms_{Peak}$	Daily peak fuel savings	Calculated	Therms/day	
ΔkWh_{Life}	Lifetime electric energy savings	Calculated	kWh	
$\Delta Therms_{Life}$	Lifetime fuel savings	Calculated	Therms	
kWh_q	Annual rated electric energy use for energy efficient condition	Site-specific. If unknown, look up in Table 2-14	kWh	[24]
kWh_b	Annual rated electric energy use for baseline condition	Look up in Table 2-14	kWh	[18]
$F_{machine}$	Fraction of energy used for the dishwasher machine	0.44	N/A	[19]
F_{wh}	Fraction of energy used for the water heater	0.56	N/A	[19]
Hrs	Annual operating hours	301	Hours	[18]
$ElecSF_{wh}$	Electric Savings Factor for water heaters	Look up in Table 2-15	N/A	[21]
$FuelSF_{wh}$	Fuel Savings Factor of water heaters	Look up in Table 2-15	N/A	[21]
1.307	Ratio of recovery efficiency of electric water heater to the recovery efficiency of fossil fuel water heater	1.307	N/A	[22][18]

Variable	Description	Value	Units	Ref
3,412	Conversion factor from kWh to Btu	3,412	Btu/kWh	
100,000	Conversion factor from Btu to therms	100,000	Btu/therm	
CF	Electric coincidence factor	Look up in Table 2-16	N/A	
PDF	Gas peak day factor	Look up in Table 2-16	N/A	
EUL	Effective useful life	See Measure Life Section	Years	

Table 2-14 Baseline and Efficient kWh

Dishwasher Type	kWh _b	kWh _e
Compact	222	203
Standard	307	270

Table 2-15 Savings Factors

Type	Electric	Fuel
Electric WH	1.00	0
Fossil Fuel WH	0	1.00
Other	0	0
Unknown	0.20	0.54

Peak Factors

Table 2-16 Peak Factors

Peak Factor	Value	Ref
Electric coincidence factor (CF)	0.029	[20]
Natural gas peak day factor (PDF)	Appendix G: Natural Gas Peak Day Factors	

Measure Life

The effective useful life (EUL) is 11 years [23].

References

[18] 10 CFR 430.32 (f)(1). [https://www.ecfr.gov/current/title-10/chapter-II/subchapter-D/part-430#p-430.32\(f\)\(1\)](https://www.ecfr.gov/current/title-10/chapter-II/subchapter-D/part-430#p-430.32(f)(1)) An average of 215 annual 1.4-hour dishwasher cycles is assumed in order to estimate conventional and qualifying energy ratings, for a total of 301 hours of active use per year.

- [19] ENERGY STAR Residential Appliance Savings Calculator, 2012.
- [20] From NY TRM v10: “Based on 8,760 end use data for Missouri, provided to VEIC by Ameren for use in the Illinois TRM. The average dishwasher load during peak hours is divided by the peak load. In the absence of a New York specific load shape, this is deemed a reasonable proxy because load shapes are not expected to vary significantly by region. Data from Ameren was adjusted to account for the difference in assumed annual operating hours (252 hours were used in the referenced study whereas 301 hours are cited in this document) and peak range was adjusted to reflect New York peak time (the hour ending in 5PM) from Illinois peak time (1PM to the hour ending 5PM).”
- [21] Based on NYSERDA Residential Statewide Baseline Study of New York State – July 2015.⁵ “Unknown” shall only be applied when the collection of information on water heating fuel is not feasible due to program configuration of delivery mechanism. ElecSF and FuelSF “unknown” factors may not sum to 100% due to the presence of other water heating fuels.
- [22] Per 10 CFR 430 Subpart B Appendix E – Uniform Test Method for Measuring the Energy Consumption of Water Heaters: *6.3.2 Recovery Efficiency*.
- [23] California Public Utilities Commission EUL Table, version 027 (updated November 12, 2022). Accessed December 30, 2022. <https://www.caetrm.com/shared-data/value-table/EUL/>
- [24] ENERGY STAR® Program Requirements for Residential Dishwashers Eligibility Criteria Version 6.0 (2016), Table 1. <https://www.energystar.gov/sites/default/files/ENERGY%20STAR%20Residential%20Dishwasher%20Version%206.0%20Final%20Program%20Requirements.pdf>

⁵ NYSERDA Residential statewide Baseline Study. Volume 1: Single Family Report, Table 38: Water Heating Fuel Type by Climate Zone. Overall statewide averages applied. ElecSF and FuelSF “unknown” factors may not sum to 100% due to the presence of other water heating fuels. In the condition of other water heating fuels in home, the designation “Other” shall be applied.

2.1.4 INDUCTION RANGE/COOKTOP

Market	Residential
Baseline Condition	RF/TOS
Baseline	Existing
End Use Subcategory	Kitchen
Measure Last Reviewed	January 2023

Description

This measure is applicable to the replacement of electric resistance and fossil fuel cooktops with electric induction cooktops in single family and multifamily in-unit kitchens. Induction cooktops heat food faster, are easier to clean, are less likely to burn those using them, and have a higher cooking efficiency than electrical resistance stoves. Conventional residential cooktops typically employ fossil fuel or resistance heating elements to transfer energy, with efficiencies of approximately 32% and 75%-80% respectively. Residential induction cooking tops instead consist of an electromagnetic coil that creates a magnetic field when supplied with an electric current. When brought into this field, compatible cookware is warmed internally, transferring energy with approximately 85% efficiency. If the replacement equipment is a range or induction cooktop, the cooktop must have either 4 or 5 burners.

Baseline Case

The baseline condition is a standalone electric resistance or fossil fuel-fired cooktop.

Efficient Case

The compliance condition is an induction cooktop with compatible cookware.

Annual Energy Savings Algorithms

Annual Electric Energy Savings

$$\Delta kWh = kWh_b \times F_{elec,b} - kWh_q$$

Where,

$$kWh_b = 1.135 \times kWh_q$$

Annual Fuel Savings

$$\Delta Therms = Therms_b \times F_{fuel,b}$$

Where,

$$Therms_b = 2.1 \times kWh_q \times \frac{3,412}{100,000}$$

Peak Demand Savings

$$\Delta kW_{Peak} = \frac{\Delta kWh}{hrs} \times CF$$

Daily Peak Fuel Savings

$$\Delta Therms_{Peak} = N/A$$

Lifetime Energy Savings Algorithms

Lifetime Electric Energy Savings

$$\Delta kWh_{Life} = \Delta kWh \times EUL$$

Lifetime Fuel Savings

$$\Delta Therms_{Life} = \Delta Therms \times EUL$$

Calculation Parameters

Table 2-17 Calculation Parameters

Variable	Description	Value	Units	Ref
ΔkWh	Annual electric energy savings	Calculated	kWh/yr	
$\Delta Therms$	Annual fuel savings	Calculated	Therms/yr	
ΔkW_{Peak}	Peak Demand Savings	Calculated	kW	
ΔkWh_{Life}	Lifetime electric energy savings	Calculated	kWh	
$\Delta Therms_{Life}$	Lifetime fuel savings	Calculated	Therms	
kWh_b	Energy consumption by electric baseline cooktop	Site-specific, if unknown use abovementioned formulae	kWh	[25]
kWh_q	Energy consumption by induction cooktop	Site-specific, if unknown use 125 kWh	kWh	[26]
hrs	Annual operating hours	Site-specific, if unknown use 365 hours	Hours	[27]
$F_{elec,b}$	Electric factor; used to account for the presence or absence of an electric cooktop in the baseline condition	Use a value of 1.0 if the baseline cooktop is electric. Otherwise, use 0.0.	N/A	
$F_{fuel,b}$	Fossil fuel factor; used to account for the presence or absence of a fossil fuel-fired cooktop in the baseline condition	Use a value of 1.0 if the baseline cooktop is fossil fuel. Otherwise, use 0.0.	N/A	
$Therms_b$	Energy consumption by fossil fuel baseline cooktop	Site-specific, if unknown use abovementioned formulae.	Therms	[28]
1.135	Relative efficiency of induction to resistance cooktops	1.135	N/A	[25]

Variable	Description	Value	Units	Ref
2.1	Relative efficiency of induction to gas cooktops	2.1	N/A	[28]
3,412	Conversion from Btu to kWh	3,412	Btu/kWh	
100,000	Conversion from Btu to therms	100,000	Btu/therm	
CF	Electric coincidence factor	See Table 2-18	N/A	
EUL	Effective useful life	See Measure Life Section	Years	[29]

Peak Factors

Table 2-18 Peak Factors

Peak Factor	Value	Ref
Electric coincidence factor (CF)	0.8	
Natural gas peak day factor (PDF)	N/A	

Measure Life

The effective useful life (EUL) is 16 years [29].

References

- [25] SWAP015-01, Induction Cooking with or without Electric Range, pg 7, May 2020. Available online at <http://deeresources.net/workpapers>. Based on relative efficiency of induction to resistance cooktops, $0.84/0.74 = 1.135$
- [26] ENERGY STAR®, Emerging Technology, 2021-2022 Residential Induction Cooking Tops, January 2023 https://www.energystar.gov/about/2021_residential_induction_cooking_tops
- [27] Frontier Energy, Residential Cooktop Performance and Energy Comparison Study, Frontier Energy Report # 501318071-R0, Table 9, July 2019. <https://cao-94612.s3.amazonaws.com/documents/Induction-Range-Final-Report-July-2019.pdf>
- [28] SWAP013-01, Residential Cooking Appliances – Fuel Substitution, pg 10; based on relative efficiency of induction to gas cooktops, $0.84/0.399 = 2.1$, May 2020
- [29] New York Standard Approach for Estimating Energy Savings from Energy Efficiency Programs (TRM), Version 9, January 2022. [https://www3.dps.ny.gov/W/PSCWeb.nsf/96f0fec0b45a3c6485257688006a701a/72c23decff52920a85257f1100671bdd/\\$FILE/NYS%20TRM%20V9.pdf](https://www3.dps.ny.gov/W/PSCWeb.nsf/96f0fec0b45a3c6485257688006a701a/72c23decff52920a85257f1100671bdd/$FILE/NYS%20TRM%20V9.pdf).

2.1.5 REFRIGERATORS

Market	Residential/Multifamily
Baseline Condition	NC/TOS/EREP/DI
Baseline	Code/Existing/Dual
End Use Subcategory	Kitchen
Measure Last Reviewed	December 2022

Description

This measure relates to the purchase and installation of a new refrigerator or refrigerator/freezer meeting either ENERGY STAR® 5.1 or Consortium for Energy Efficiency (CEE) TIER 2 or TIER 3 specifications (defined as requiring ≥10%, ≥15% or ≥ 20% less energy consumption than an equivalent unit meeting federal standard requirements respectively).

Baseline Case

Early Replacement (EREP): Early replacement uses a dual baseline. The baseline is the existing unit for the remaining life of the existing unit and the baseline is a code-compliant/standard efficiency unit for the remaining life of the installed equipment. Savings are calculated between the existing unit and the new efficient unit consumption during the assumed remaining life of the existing unit, and between a hypothetical new baseline unit and the efficient unit consumption for the remainder of the measure life.

Normal Replacement(NR) and new construction (NC): The baseline condition is a new refrigerator meeting the minimum federal efficiency standard for refrigerator efficiency as presented below.

Efficient Case

The efficient condition is a high-efficiency refrigerator meeting ENERGY STAR® 5.1 or Consortium for Energy Efficiency (CEE) TIER 2 or TIER 3 specifications requirements.

Annual Energy Savings Algorithm

Annual Electric Energy Savings

Normal replacement and TOS (compared to code baseline):

$$\Delta kWh_{NR/TOS} = (kWh_b - kWh_q) \times (1 + HVAC_c) \times F_{occ}$$

Early replacement and DI (compared to existing baseline):

$$\Delta kWh_{EREP/DI} = (kWh_{ex} - kWh_q) \times (1 + HVAC_c) \times F_{occ}$$

Annual Fuel Savings

Normal replacement and TOS (compared to code baseline):

$$\Delta Therms_{NR/TOS} = (kWh_b - kWh_q) \times HVAC_{ff} \times F_{occ} \times 10$$

Early replacement and DI (compared to existing equipment):

$$\Delta Therms_{EREP/DI} = (kWh_{ex} - kWh_q) \times HVAC_{ff} \times F_{occ} \times 10$$

Peak Demand Savings

Normal replacement and TOS (compared to code baseline):

$$\Delta kW_{Peak,NR/TOS} = \left(\frac{kWh_b - kWh_q}{8,760} \right) \times (1 + HVAC_d) \times CF$$

Early replacement and DI (compared to existing equipment):

$$\Delta kW_{Peak,EREP/DI} = \left(\frac{kWh_{ex} - kWh_q}{8,760} \right) \times (1 + HVAC_d) \times CF$$

Daily Peak Fuel Savings

$$\Delta Therms_{Peak} = \Delta Therms \times PDF$$

Lifetime Energy Savings Algorithms:

Normal replacement and TOS (compared to code baseline):

Lifetime Electric Energy Savings

$$\Delta kWh_{Life} = \Delta kWh_{NR/TOS} \times EUL$$

Lifetime Fuel Savings

$$\Delta Therms_{Life} = \Delta Therms_{NR/TOS} \times EUL$$

Early replacement and DI (compared to existing equipment):

Lifetime Electric Energy Savings

$$\Delta kWh_{Life} = \Delta kWh_{EREP/DI} \times RUL + \Delta kWh_{NR/TOS} \times (EUL - RUL)$$

Lifetime Fuel Savings

$$\Delta Therms_{Life} = \Delta Therms_{EREP/DI} \times RUL + \Delta Therms_{NR/TOS} \times (EUL - RUL)$$

Calculation Parameters

Table 2-19 Calculation Parameters

Variable	Description	Value	Units	Ref
$\Delta kWh_{NR/TOS}$	Annual electric energy savings for normal replacement	Calculated	kWh/yr	
$\Delta kWh_{EREP/DI}$	Annual electric energy savings for early replacement	Calculated	kWh/yr	
$\Delta Therms_{NR/TOS}$	Annual fuel savings for normal replacement	Calculated	Therms/yr	
$\Delta Therms_{EREP/DI}$	Annual fuel savings for early replacement	Calculated	Therms/yr	
$\Delta kW_{Peak,NR/TOS}$	Peak Demand Savings for normal replacement	Calculated	kWr	
$\Delta kW_{Peak,EREP/DI}$	Peak Demand Savings for early replacement	Calculated	kW	
$\Delta Therms_{Peak}$	Daily peak fuel savings	Calculated	Therms/day	
ΔkWh_{Life}	Lifetime electric energy savings	Calculated	kWh	
$\Delta Therms_{Life}$	Lifetime fuel savings	Calculated	Therms	
$\Delta Therms_{Peak}$	Daily peak fuel savings	Calculated	Therms/day	
ΔkWh_{Life}	Lifetime electric energy savings	Calculated	kWh	
$\Delta Therms_{Life}$	Lifetime fuel savings	Calculated	Therms	
AV	Adjusted volume of refrigerator	Site-specific	ft ³	
kWh_{ex}	Annual energy consumption of existing unit	Site-specific ⁶	kWh/yr	
kWh_q	Annual energy consumption of qualifying efficiency unit	Site-specific, if unknown look up in Table 2-20 for ENERGY STAR specifications and Table 2-21 for CEE specifications Table 2-20	kWh/yr	[31][34]
kWh_b	Annual energy consumption of code-compliant baseline unit	Site-specific, if unknown look up in Table 2-20	kWh/yr	[30]
F_{occ}	Adjustment factor to account for number of occupants	Look up in Table 2-28, if unknown use 1.0	N/A	[32]
CF	Electric coincidence factor	Look up in Table 2-23	N/A	
PDF	Gas peak day factor	Look up in Table 2-23	N/A	

⁶ The Annual Energy Consumption of existing unit can be determined in preference order of: 1) Field measurement 2) EnergyGuide Label on the equipment 3) Manufacturer Rated kWh Usage 4) Residential Appliance Recycling measure

Variable	Description	Value	Units	Ref
HVAC _c	HVAC interaction factor for annual electric energy consumption	0.080. If unconditioned space, use 0	N/A	
HVAC _d	HVAC interaction factor for peak demand at utility summer peak hour	0.175. If unconditioned space, use 0	N/A	
HVAC _{ff}	HVAC interaction factor for annual fossil fuel energy consumption	-0.002. If unconditioned space or electric heat use 0	MMBtu/kWh	
8,760	Hours per year	8,760	Hrs/yr	
10	Unit conversion, Therm/MMBtu	10	Therms/MMBtu	
EUL	Effective useful life of new unit	See Measure Life Section	Years	
RUL	Remaining useful life of existing unit	See Measure Life Section	Years	

Table 2-20 Federal Standard and ENERGY STAR Refrigerator Maximum Annual Energy Consumption

Product Category	Federal Baseline Maximum Energy Usage, kWh _b	ENERGY STAR Maximum Energy Usage, kWh _q
Standard Size Models: 7.75 cubic feet or greater		
1. Refrigerator-freezers and refrigerators other than all-refrigerators with manual defrost.	$7.99 \times AV + 225.0$	$7.19 \times AV + 202.5$
1A. All-refrigerators—manual defrost.	$6.79 \times AV + 193.6$	$6.11 \times AV + 174.2$
2. Refrigerator-freezers—partial automatic defrost	$7.99 \times AV + 225.0$	$7.19 \times AV + 202.5$
3. Refrigerator-freezers—automatic defrost with top-mounted freezer without an automatic icemaker.	$8.07 \times AV + 233.7$	$7.26 \times AV + 210.3$
3-BI. Built-in refrigerator-freezer—automatic defrost with top-mounted freezer without an automatic icemaker.	$9.15 \times AV + 264.9$	$8.24 \times AV + 238.4$
3I. Refrigerator-freezers—automatic defrost with top-mounted freezer with an automatic icemaker without through-the-door ice service.	$8.07 \times AV + 317.7$	$7.26 \times AV + 294.3$
3I-BI. Built-in refrigerator-freezers—automatic defrost with top-mounted freezer with an automatic icemaker without through-the-door ice service.	$9.15 \times AV + 348.9$	$8.24 \times AV + 322.4$
3A. All-refrigerators—automatic defrost.	$7.07 \times AV + 201.6$	$6.36 \times AV + 181.4$
3A-BI. Built-in All-refrigerators—automatic defrost.	$8.02 \times AV + 228.5$	$7.22 \times AV + 205.7$
4. Refrigerator-freezers—automatic defrost with side-mounted freezer without an automatic icemaker.	$8.51 \times AV + 297.8$	$7.66 \times AV + 268.0$
4-BI. Built-In Refrigerator-freezers—automatic defrost with side-mounted freezer without an automatic icemaker.	$10.22 \times AV + 357.4$	$9.20 \times AV + 321.7$

Product Category	Federal Baseline Maximum Energy Usage, kWh _b	ENERGY STAR Maximum Energy Usage, kWh _q
4I. Refrigerator-freezers—automatic defrost with side-mounted freezer with an automatic icemaker without through-the-door ice service.	$8.51 \times AV + 381.8$	$7.66 \times AV + 352.0$
4I-BI. Built-In Refrigerator-freezers—automatic defrost with side-mounted freezer with an automatic icemaker without through-the-door ice service.	$10.22 \times AV + 441.4$	$9.20 \times AV + 405.7$
5. Refrigerator-freezers—automatic defrost with bottom-mounted freezer without an automatic icemaker.	$8.85 \times AV + 317.0$	$7.97 \times AV + 285.3$
5-BI. Built-In Refrigerator-freezers—automatic defrost with bottom-mounted freezer without an automatic icemaker.	$9.40 \times AV + 336.9$	$8.46 \times AV + 303.2$
5I. Refrigerator-freezers—automatic defrost with bottom-mounted freezer with an automatic icemaker without through-the-door ice service.	$8.85 \times AV + 401.0$	$7.97 \times AV + 369.3$
5I-BI. Built-In Refrigerator-freezers—automatic defrost with bottom-mounted freezer with an automatic icemaker without through-the-door ice service.	$9.40 \times AV + 420.9$	$8.46 \times AV + 387.2$
5A. Refrigerator-freezer—automatic defrost with bottom-mounted freezer with through-the-door ice service.	$9.25 \times AV + 475.4$	$8.33 \times AV + 436.3$
5A-BI. Built-in refrigerator-freezer—automatic defrost with bottom-mounted freezer with through-the-door ice service.	$9.83 \times AV + 499.9$	$8.85 \times AV + 458.3$
6. Refrigerator-freezers—automatic defrost with top-mounted freezer with through-the-door ice service.	$8.40 \times AV + 385.4$	$7.56 \times AV + 355.3$
7. Refrigerator-freezers—automatic defrost with side-mounted freezer with through-the-door ice service.	$8.54 \times AV + 432.8$	$7.69 \times AV + 397.9$
7-BI. Built-In Refrigerator-freezers—automatic defrost with side-mounted freezer with through-the-door ice service.	$10.25 \times AV + 502.6$	$9.23 \times AV + 460.7$
Compact Size Models: Less than 7.75 cubic feet		
11. Compact refrigerator-freezers and refrigerators other than all-refrigerators with manual defrost.	$9.03 \times AV + 252.3$	$8.13 \times AV + 227.1$
11A. Compact all-refrigerators—manual defrost.	$7.84 \times AV + 219.1$	$7.06 \times AV + 197.2$
12. Compact refrigerator-freezers—partial automatic defrost	$5.91 \times AV + 335.8$	$5.32 \times AV + 302.2$
13. Compact refrigerator-freezers—automatic defrost with top-mounted freezer.	$11.80 \times AV + 339.2$	$10.62 \times AV + 305.3$
13I. Compact refrigerator-freezers—automatic defrost with top-mounted freezer with an automatic icemaker.	$11.80 \times AV + 423.2$	$10.62 \times AV + 389.3$
13A. Compact all-refrigerators—automatic defrost.	$9.17 \times AV + 259.3$	$8.25 \times AV + 233.4$
14. Compact refrigerator-freezers—automatic defrost with side-mounted freezer.	$6.82 \times AV + 456.9$	$6.14 \times AV + 411.2$
14I. Compact refrigerator-freezers—automatic defrost with side-mounted freezer with an automatic icemaker.	$6.82 \times AV + 540.9$	$6.14 \times AV + 495.2$

Product Category	Federal Baseline Maximum Energy Usage, kWh _b	ENERGY STAR Maximum Energy Usage, kWh _q
15. Compact refrigerator-freezers—automatic defrost with bottom-mounted freezer.	$11.80 \times AV + 339.2$	$10.62 \times AV + 305.3$
15I. Compact refrigerator-freezers—automatic defrost with bottom-mounted freezer with an automatic icemaker.	$11.80 \times AV + 423.2$	$10.62 \times AV + 389.3$

Where $AV = \text{fresh volume} + (1.63 \times \text{freezer volume})$

Table 2-21 CEE Residential Refrigerator Efficiency Specification

Efficiency Level	Percent Improvement Over Measured ⁷ Federal Minimum Efficiency Standard
CEE Tier 1 ⁸	10
CEE Tier 2	15
CEE Tier 3	30

Table 2-22 Occupant Adjustment Factor

Number of Occupants	F _{occ}
0	1.00
1	1.05
2	1.10
3	1.13
4	1.15
5 or more	1.16
Unknown	1.00

Peak Factors

Table 2-23 Peak Factors

Peak Factor	Value	Ref
Electric coincidence factor (CF)	1.0	
Natural gas peak day factor (PDF)	See Appendix G: Natural Gas Peak Day Factors	

⁷ Measure Minimum Efficiency Standard is defined as the measured energy consumption of the refrigerator according to the DOE test method, prior to the application of any adder (84 kWh/yr) for automatic icemakers. For refrigerators with automatic icemakers, the percentage improvement is calculated by dividing the difference in annual energy use by the minimum efficiency standard, less the 84 kWh/yr adder.

⁸ CEE Tier 1 is aligned with the ENERGY STAR Version 5.1 specification for residential refrigerators.

Measure Life

The remaining useful life (RUL) for existing equipment is limited to 1/3 of the effective useful life (EUL) of the equipment.

Table 2-24 Measure Life

Equipment	EUL	RUL	Ref
Refrigerator	12	4	[33]

References

- [30] 10 CFR Subpart C of Part 430, <https://www.ecfr.gov/current/title-10/chapter-II/subchapter-D/part-430/subpart-C/section-430.32>
- [31] ENERGY STAR Program Requirements Product Specifications for Residential Refrigerators and Freezers Version 5.1. Effective 9/15/2014.
https://www.energystar.gov/sites/default/files/asset/document/Refrigerators_and_Freezers_Program_Requirements_V5.1.pdf
- [32] The Occupant Adjustment Factor is developed from simulating audits within the Oak Ridge National Laboratory, National Energy Audit Tool (NEAT), 2012. <https://weatherization.ornl.gov/obtain/>
- [33] California Public Utilities Commission Database for Energy Efficient Resources (DEER) EUL Support Table for 2020, <http://www.deeresources.com/files/DEER2020/download/SupportTable-EUL2020.xlsx>. Accessed December 2022.
- [34] CEE, 2022 CEE Home Appliances Initiative and Residential Refrigerator Specification, May 2022
<https://library.cee1.org/content/cee-residential-refrigerator-specification>

2.1.6 FREEZER

Market	Residential
Baseline Condition	NC/TOS/RF/EREP
Baseline	Code/Existing/Dual
End Use Subcategory	Kitchen
Measure Last Reviewed	December 2022

Description

This measure relates to the promotion of residential freezers meeting the ENERGY STAR 5.1 criteria through retail channels and through upstream efforts such as the ENERGY STAR Retail Products Program. In the measure, a freezer meeting the efficiency specifications of ENERGY STAR is installed in place of a model meeting the federal standard (NAECA). Energy usage specifications are defined in the tables below. Freezer adjusted volume used in the specifications is calculated as follows:

$$AV = 1.76 \times (\text{total freezer volume})$$

Baseline Case

The baseline equipment is assumed to be a freezer model that meets the federal minimum standard for energy efficiency. The standard varies depending on the type of the freezer (chest or upright freezer), its size category (full or compact) and other attributes (defrost type and presence of through the door ice) and is defined in the tables below.

Efficient Case

The efficient equipment is defined as a freezer meeting the freezer efficiency specifications of ENERGY STAR v 5.1, as calculated below.

Annual Energy Savings Algorithms

Annual Electric Energy Savings

$$\Delta kWh = (kWh_b - kWh_q) \times (1 + HVAC_c) \times F_{occ}$$

Annual Fuel Savings

$$\Delta Therms = (kWh_b - kWh_q) \times HVAC_{ff} \times F_{occ} \times 10$$

Peak Demand Savings

$$\Delta kW_{Peak} = \left(\frac{kWh_b - kWh_q}{8,760} \right) \times (1 + HVAC_d) \times TAF \times LSAF$$

Daily Peak Fuel Savings

$$\Delta Therms_{Peak} = \Delta Therms \times PDF$$

Lifetime Energy Savings Algorithms

Lifetime Electric Energy Savings

No dual baseline:

$$\Delta kWh_{Life} = \Delta kWh \times EUL$$

Dual baseline:

$$\Delta kWh_{Life} = (\Delta kWh \text{ using existing baseline}) \times RUL + (\Delta kWh \text{ using code baseline}) \times (EUL - RUL)$$

Lifetime Fuel Energy Savings

No dual baseline:

$$\Delta Therms_{Life} = \Delta Therms \times EUL$$

Dual baseline:

$$\Delta Therms_{Life} = (\Delta Therms \text{ using existing baseline}) \times RUL + (\Delta Therms \text{ using code baseline}) \times (EUL - RUL)$$

Calculation Parameters

Table 2-25 Calculation Parameters

Variable	Description	Value	Units	Ref
ΔkWh	Annual electric energy savings	Calculated	kWh/yr	
$\Delta Therms$	Annual fuel savings	Calculated	Therms/yr	
ΔkW_{Peak}	Peak Demand Savings	Calculated	kW	
$\Delta Therms_{Peak}$	Daily peak fuel savings	Calculated	Therms/day	
ΔkWh_{Life}	Lifetime electric energy savings	Calculated	kWh	
$\Delta Therms_{Life}$	Lifetime fuel savings	Calculated	Therms	
kWh_b	kWh consumption for baseline case	Look up in Table 2-26, if volume unknown use Table 2-27	kWh/yr	[35]
kWh_q	kWh consumption for energy efficient case	Site-specific, if unknown look up in Table 2-26. If volume unknown use Table 2-27	kWh/yr	[36]

Variable	Description	Value	Units	Ref
F_{occ}	Adjustment factor to account for number of occupants	Look up in Table 2-28. If unknown use 1.0	N/A	[41]
$HVAC_c$	HVAC interaction factor for annual electric energy consumption	0.080. If unconditioned space use 0	N/A	
$HVAC_d$	HVAC interaction factor for peak demand at utility summer peak hour	0.175. If unconditioned space use 0	N/A	
$HVAC_{ff}$	HVAC interaction factor for annual fossil fuel energy consumption	-0.002. If unconditioned space use 0	MMBtu/kWh	
TAF	Temperature Adjustment Factor	1.23	N/A	[38]
LSAF	Load Shape Adjustment Factor	1.15	N/A	[39]
CF	Electric coincidence factor	Look up in Table 2-29	N/A	
PDF	Gas peak day factor	Look up in Table 2-29	N/A	
EUL	Effective useful life	See Measure Life Section	Years	
RUL	Remaining useful life	See Measure Life Section	Years	

Table 2-26 Freezer Baseline and Efficient Annual kWh Consumption

Product Class	Baseline Annual kWh Consumption (kWh _b) [35]	Energy Efficient Annual kWh Consumption (kWh _e) [36]
Full-Size Freezers, where AV is adjusted volume		
8. Upright freezers with manual defrost	$5.57 \times AV + 193.7$	$5.01 \times AV + 174.3$
9. Upright freezers with automatic defrost without an automatic icemaker	$8.62 \times AV + 228.3$	$7.76 \times AV + 205.5$
9I. Upright freezers with automatic defrost with an automatic icemaker	$8.62 \times AV + 312.3$	$7.76 \times AV + 289.5$
9-BI. Built-In upright freezers with automatic defrost without an automatic icemaker	$9.86 \times AV + 260.9$	$8.87 \times AV + 234.8$
9I-BI. Built-in upright freezers with automatic defrost with an automatic icemaker	$9.86 \times AV + 344.9$	$8.87 \times AV + 318.8$
10. Chest freezers and all other freezers except compact freezers	$7.29 \times AV + 107.8$	$6.56 \times AV + 97.0$
10A. Chest freezers with automatic defrost	$10.24 \times AV + 148.1$	$9.22 \times AV + 133.3$
Compact Freezers, where AV is adjusted volume		
16. Compact upright freezers with manual defrost	$8.65 \times AV + 225.7$	$7.79 \times AV + 203.1$
17. Compact upright freezers with automatic defrost	$10.17 \times AV + 351.9$	$9.15 \times AV + 316.7$

Product Class	Baseline Annual kWh Consumption (kWh _b) [35]	Energy Efficient Annual kWh Consumption (kWh _q) [36]
18. Compact chest freezers	$9.25 \times AV + 136.8$	$8.33 \times AV + 123.1$

If freezer volume is unknown, use the default consumption values in Table 2-27.

Table 2-27 Default Values

Product Category	AV (assumed)	kWh _b	kWh _q	Market Share Weighting [37]
Upright Freezer	24.4	439	395	36.74%
Chest Freezer	18.0	239	215	63.26%
Weighted Average		313	281	100%

Table 2-28 Occupant Adjustment Factor

Number of Occupants	F _{occ}
0	1.00
1	1.05
2	1.10
3	1.13
4	1.15
5 or more	1.16

Peak Factors

Table 2-29 Peak Factors

Peak Factor	Value	Ref
Electric coincidence factor (CF)	1.0	
Natural gas peak day factor (PDF)	N/A	

Measure Life

The remaining useful life (RUL) for existing equipment is limited to 1/3 of the effective useful life (EUL) of the equipment.

Table 2-30 Measure Life

Equipment	EUL	RUL	Ref
Freezer	11	3.66	[40]

References

- [35] "Electronic Code of Federal Regulations (ECFR)." 2020. <https://www.ecfr.gov/cgi-bin/>
- [36] "ENERGY STAR Program Requirements for Residential Refrigerators and Freezers Partner Commitments." https://www.energystar.gov/ia/partners/product_specs/program_reqs/Refrigerators_and_Freezers_Program_Requirements_V5.0.pdf.
- [37] The weighted average unit energy savings is calculated using the market share of upright and chest freezers. The assumed market share, as presented in the table above, comes from 2011 NIA-Frz-2008 Shipments data.
- [38] Temperature adjustment factor based on Blasnik, Michael, "Measurement and Verification of Residential Refrigerator Energy Use, Final Report 2003-2004 Metering Study", July 29, 2004 (p.47) and assuming 78% of refrigerators are in cooled space (based on BGE Energy Use Survey, Report of Findings, December 2005; Mathew Greenwalk & Associates) and 22% in un-cooled space. Although this evaluation is based upon refrigerators only it is considered a reasonable estimate of the impact of cycling on freezers and gave exactly the same result as an alternative methodology based on Freezer eShape data.
- [39] Daily load shape adjustment factor also based on Blasnik, Michael, "Measurement and Verification of Residential Refrigerator Energy Use, Final Report, 2003-2004 Metering Study", July 29, 2004 (p. 48), (extrapolated by taking the ratio of existing summer to existing annual profile for hours ending 15 through 18, and multiplying by new annual profile).
- [40] ENERGY STAR assumes 11 years based on Appliance Magazine U.S. Appliance Industry: Market Value, Life Expectancy & Replacement Picture for 2005-2012, 2011.
- [41] The Occupant Adjustment Factor is developed from simulating audits within the ORNL weatherization tool, National Energy Audit Tool (NEAT), Oak Ridge National Laboratory, 2012.

2.1.7 WATER COOLER

Market	Residential
Baseline Condition	NC/TOS
Baseline	Code
End Use Subcategory	Kitchen
Measure Last Reviewed	December 2022

Description

This measure estimates savings for installing ENERGY STAR Water Coolers compared to standard efficiency equipment in residential applications. The measurement of energy and demand savings is based on a deemed savings value multiplied by the quantity of the measure.

Baseline Case

Residential water cooler meeting Energy Star v. 2.0 Water Cooler requirements as directed by N.J. PL 2021, c. 464.

Efficient Case

ENERGY STAR v. 3.0 compliant residential water cooler.

Annual Energy Savings Algorithms

Annual Electric Energy Savings

$$\Delta kWh = (kWh_b - kWh_q) \times 365$$

Annual Fuel Savings

$$\Delta Therms = N/A$$

Peak Demand Savings

$$\Delta kW_{peak} = \frac{\Delta kWh}{Hr} \times CF$$

Daily Peak Fuel Savings

$$\Delta Therms_{peak} = N/A$$

Lifetime Energy Savings Algorithms

Lifetime Electric Energy Savings

$$\Delta kWh_{Life} = \Delta kWh \times EUL$$

Lifetime Fuel Savings

$$\Delta Therms_{Life} = N/A$$

Calculation Parameters

Table 2-31 Calculation Parameters

Variable	Description	Value	Units	Ref
ΔkWh	Annual electric energy savings	Calculated	kWh/yr	
ΔkW_{Peak}	Peak Demand Savings	Calculated	kW	
ΔkWh_{Life}	Lifetime electric energy savings	Calculated	kWh	
Hr	Annual hours of operation	Site-specific. If unknown, assume 8,760	Hrs	
kWh_b	Energy use of baseline water cooler	Look up in Table 2-32	kWh/day	[42]
kWh_q	Energy use of energy efficient water cooler	Site-specific. If unknown, look up in Table 2-32	kWh/day	[43]
CF	Electric coincidence factor	Look up in Table 2-33	N/A	
PDF	Gas peak day factor	Look up in Table 2-33	N/A	
EUL	Effective useful life	See Measure Life Section	Years	

Table 2-32 Water Cooler Energy Use

Energy Star Water Cooler Type Product Capacity Class, and Conditioning Method	Baseline kWh_b (kWh/day)	Default Efficient kWh_q (kWh/day)
Cold Only	0.16	0.16
Hot & Cold – Low Capacity ⁹	0.87	0.68
Hot & Cold – High Capacity ¹⁰	0.87	0.80
Hot & Cold On-Demand	0.18	0.18

⁹ A water cooler with a cold-water dispenser capacity of 0.50 gallons per hour or less, as measured per ANSI/ASHRAE Standard 18. For units that also provide hot water, the unit must have a hot-water dispenser capacity that is equal to or less than 41 exact 6 oz. cups per hour, as rated per ANSI/ASHRAE Standard 18.

¹⁰ A water cooler with a cold-water dispenser capacity that is greater than 0.50 gallons per hour, as measured per ANSI/ASHRAE Standard 18. For units that also provide hot water, the unit must have a hot-water dispenser capacity greater than 41 exact 6 oz. cups per hour, as rated per ANSI/ASHRAE Standard 18.

Peak Factors

Table 2-33 Peak Factors

Peak Factor	Value	Ref
Electric coincidence factor (CF)	1.0	[44]
Natural gas peak day factor (PDF)	N/A	

Measure Life

The effective useful life (EUL) is 10 years. [42]

References

[42] ENERGY STAR Product Specification for Water Coolers Version 2.0.

<https://www.energystar.gov/sites/default/files/specs//ES%20WC%20V2%200%20Spec.pdf>

[43] ENERGY STAR Product Specifications for Water Coolers Version 3.0.

https://www.energystar.gov/sites/default/files/asset/document/ENERGY%20STAR%20Verison%203.0%20Water%20Coolers%20Final%20Specification_0.pdf

[44] Assumes 24/7 operation. Site-specific load shape information should be used if known.

2.1.8 AIR PURIFIER

Market	Residential/Multifamily/Low Income
Baseline Condition	TOS
Baseline	ISP
End Use Subcategory	Indoor Environment
Measure Last Reviewed	December 2022

Description

An air purifier (cleaner) meeting the efficiency specifications of ENERGY STAR is purchased and installed in place of a model meeting the New Jersey P.L. 2021, c. 464 minimum standards. Compliance with this standard will start on January 1, 2023. The Coincidence factor (CF) assumes that the purifier usage is evenly spread throughout the year and the annual active operating hours assume that the air purifier operates 16 hours a day for 365 days[48].

Baseline Case

The baseline equipment is assumed to be a conventional non-ENERGY STAR unit, meeting the New Jersey P.L. 2021, c. 464 minimum standards.

Efficient Case

The efficient equipment is defined as an air purifier meeting the efficiency specifications of ENERGY STAR Version 2.0. Certified air cleaner models shall produce a minimum 30 CADR for Smoke to be considered under this specification.

Annual Energy Savings Algorithm

Annual Electric Energy Savings

$$\Delta kWh = kWh_b - kWh_q$$

Where,

$$kWh_b = Hrs \times \left(\frac{CADR_b}{CADR_per_watt_b \times 1,000} \right) + (8,760 - Hrs) \times \frac{PartialPower_b}{1,000}$$

$$kWh_q = Hrs \times \left(\frac{CADR_q}{CADR_per_watt_q \times 1,000} \right) + (8,760 - Hrs) \times \frac{PartialPower_q}{1,000}$$

Annual Fuel Savings

$$\Delta Therms = N/A$$

Peak Demand Savings

$$\Delta kW_{Peak} = \frac{\Delta kWh}{Hrs} \times CF$$

Daily Peak Fuel Savings

$$\Delta Therms_{Peak} = N/A$$

Lifetime Energy Savings Algorithms:

Lifetime Electric Energy Savings

$$\Delta kWh_{Life} = \Delta kWh \times EUL$$

Lifetime Fuel Savings

$$\Delta Therms_{Life} = N/A$$

Calculation Parameters

Table 2-34 Calculation Parameters

Variable	Description	Value	Units	Ref
ΔkWh	Annual electric energy savings	Calculated	kWh/yr	
ΔkW_{Peak}	Peak Demand Savings	Calculated	kW	
ΔkWh_{Life}	Lifetime electric energy savings	Calculated	kWh	
kWh_b	Annual electric consumption of the baseline case	Calculated	kWh/yr	
kWh_q	Annual electric consumption of the efficient case	Calculated	kWh/yr	
$\Delta Therms_{Life}$	Lifetime fuel savings	Calculated	Therms	
$CADR_b$	Clean Air Delivery Rate (CADR) for baseline air purifier	Look up in Table 2-35	cfm	[45]
$CADR_{per_watt_b}$	Clean Air Delivery Rate (CADR) per watt for baseline air purifier	Look up in Table 2-35	cfm/Watt	[45]
$PartialPower_b$	Partial On Model Power for baseline air purifier by category	Look up in Table 2-35	Watts	[45]
$CADR_q$	Clean Air Delivery Rate (CADR) for efficient air purifier	Site-specific. If unknown, look up in Table 2-36	cfm	[46]
$CADR_{per_watt_q}$	Clean Air Delivery Rate (CADR) per watt for efficient air purifier	Site-specific. If unknown, look up in Table 2-36	cfm/watt	[46]
$PartialPower_q$	Partial On Model Power for efficient air purifier by category	Site-specific. If unknown, look up in Table 2-36	Watts	[46]

Variable	Description	Value	Units	Ref
Hrs	Annual active operating hours	5,840	Hrs	[48]
CF	Electric coincidence factor	Look up in Table 2-39	N/A	
EUL	Effective useful life	See Measure Life Section	Years	
1,000	Conversion from Watts to kW	1,000	Watts/kW	
8,760	Hours per year	8,760	Hours	

Table 2-35 Baseline Air Purifier Specifications

Clean Air Delivery Rate (CADR) Range	CADR used in deemed savings calculation	CADR per Watt	Partial On Mode Power with WiFi connection (Watts)	Partial On Mode Power without WiFi connection (Watts)
$51 \leq \text{CADR} < 100$	75	1.7	2	1
$101 \leq \text{CADR} < 150$	125	1.9	2	1
$151 \leq \text{CADR} < 200$	175	2.0	2	1
$201 \leq \text{CADR} < 250$	225	2.0	2	1
$\text{CADR} \geq 250$	275	2.0	2	1

Table 2-36 Efficient Air Purifier Specifications

Clean Air Delivery Rate (CADR) Range	CADR used in deemed savings calculation	Minimum Smoke CADR per Watt	Maximum Partial On Mode Power with WiFi connection (watts)	Maximum Partial On Mode Power without WiFi connection (watts)
$51 \leq \text{CADR} < 100$	75	1.9	2	1
$101 \leq \text{CADR} < 150$	125	2.4	2	1
$151 \leq \text{CADR} < 200$	175	2.9	2	1
$201 \leq \text{CADR} < 250$	225	2.9	2	1
$\text{CADR} \geq 250$	275	2.9	2	1

Table 2-37 Deemed kWh Savings

Clean Air Delivery Rate (CADR) Range	CADR used in deemed savings calculation	kWh Savings	
		Maximum Partial On Mode Power with WiFi connection	Maximum Partial On Mode Power without WiFi connection
$51 \leq \text{CADR} < 100$	75	27	27

Clean Air Delivery Rate (CADR) Range	CADR used in deemed savings calculation	kWh Savings	
		Maximum Partial On Mode Power with WiFi connection	Maximum Partial On Mode Power without WiFi connection
101 ≤ CADR < 150	125	80	80
151 ≤ CADR < 200	175	159	159
201 ≤ CADR < 250	225	204	204
CADR ≥ 250	275	249	249

Table 2-38 Deemed kW Savings

Clean Air Delivery Rate (CADR) Range	CADR used in deemed savings calculation	kW Savings	
		Maximum Partial On Mode Power with WiFi connection	Maximum Partial On Mode Power without WiFi connection
51 ≤ CADR < 100	75	0.0031	0.0031
101 ≤ CADR < 150	125	0.0091	0.0091
151 ≤ CADR < 200	175	0.0181	0.0181
201 ≤ CADR < 250	225	0.0233	0.0233
CADR ≥ 250	275	0.0285	0.0285

Peak Factors

Table 2-39 Peak Factors

Peak Factor	Value	Ref
Electric coincidence factor (CF)	0.667 ¹¹	
Natural gas peak day factor (PDF)	N/A	

Measure Life

The effective useful life (EUL) is 9 years [47].

References

- [45] “New Jersey A5160 | 2020-2021 | Regular Session.” n.d. LegiScan. Accessed December 21, 2022. <https://legiscan.com/NJ/text/A5160/2020>

¹¹ Assumes equal likelihood of usage at any time of day (16/24 hours)

- [46] "ENERGY STAR Program Requirements for Room Air Cleaners -Partner Commitments ENERGY STAR ® Program Requirements for Room Air Cleaners Partner Commitments, Version 2.0 Rev. May 2002." n.d. Accessed December 21, 2022.
<https://www.energystar.gov/sites/default/files/asset/document/ENERGY%20STAR%20Version%202.0%20Room%20Air%20Cleaners%20Specification%20%28Rev.%20May%202022%29.pdf>
- [47] EPA, Consumer Messaging Guide for Energy Star Certified Appliances. August 2018.
https://www.energystar.gov/sites/default/files/asset/document/ES_Consumer_Messaging_Guide_2018_508-c.pdf
- [48] "ENERGY STAR Appliance Calculator". <https://www.energy.gov/energysaver/maps/appliance-energy-calculator>. n.d. Accessed December 21, 2022.

2.1.9 DEHUMIDIFIER

Market	Residential/Multifamily/Low Income
Baseline Condition	TOS/NC
Baseline	Code /ISP
End Use Subcategory	Indoor Environment
Measure Last Reviewed	January 2023

Description

This measure covers the installation of residential stand-alone or whole-house dehumidifiers meeting the minimum qualifying efficiency standards established under the ENERGY STAR® Program, Version 5.0, effective October 31, 2019. This measure is restricted to dehumidifiers with a product moisture removal capacity of less than or equal to 185 pints/day.

Baseline Case

The baseline condition is a stand-alone or whole-house dehumidifier meeting the minimum effective federal standard for performance.

Dehumidifiers manufactured and distributed in commerce on or after June 13, 2019, must meet the energy conservation standards, rated in Integrated Energy Factor as specified in the Code of Federal Regulations.

Efficient Case

The compliance condition is an ENERGY STAR® v. 5 qualified stand-alone or whole-house dehumidifier.

Annual Energy Savings Algorithms

Annual Electric Energy Savings

$$\Delta kWh = \frac{\text{pints/day} \times 0.473 \times \text{hrs}}{24} \times \left(\frac{1}{IEF_b} - \frac{1}{IEF_q} \right)$$

Annual Fuel Savings

$$\Delta \text{Therms} = N/A$$

Peak Demand Savings

$$\Delta kW_{\text{Peak}} = \frac{\Delta kWh}{\text{hrs}} \times CF$$

Daily Peak Fuel Savings

$$\Delta \text{Therms}_{\text{Peak}} = N/A$$

Lifetime Energy Savings Algorithms

Lifetime Electric Energy Savings

$$\Delta kWh_{Life} = \Delta kWh \times EUL$$

Lifetime Fuel Savings

$$\Delta Therms_{Life} = N/A$$

Calculation Parameters

Table 2-40 Calculation Parameters

Variable	Description	Value	Units	Ref
ΔkWh	Annual electric energy savings	Calculated	kWh/yr	
ΔkW_{Peak}	Peak Demand Savings	Calculated	kW	
ΔkWh_{Life}	Lifetime electric energy savings	Calculated	kWh	
Pints/day	Product capacity to remove moisture	Site-specific	(pints/day)	
hrs	Annual run hours of dehumidifier	2,160	Hrs	[49]
IEF _b	Baseline Integrated Energy Factor	Look up in Table 2-41, Table 2-42	liters/kWh	[50]
IEF _q	Energy Efficient Integrated Energy Factor	Site-specific. If unknown, look up in Table 2-43, Table 2-44	liters/kWh	[51]
0.473	Conversion factor from liters to pint	0.473	liters/pint	
24	Hours in one day	24	N/A	
CF	Electric coincidence factor	Look up in Table 2-45	N/A	[52]
EUL	Effective useful life	See Measure Life Section	Years	

Table 2-41 Stand-Alone Dehumidifiers Baseline Integrated Energy Factor

Product Capacity (pints/day)	Integrated Energy Factor (liters/kWh)
≤ 25.00	1.30
25.01 to 50.00	1.60
≥ 50.01	2.80

Table 2-42 Whole-House Dehumidifiers Baseline Integrated Energy Factor

Product Case Volume (ft ³)	Integrated Energy Factor (liters/kWh)
≤ 8.0	≥ 1.77

Product Case Volume (ft ³)	Integrated Energy Factor (liters/kWh)
> 8.0	≥2.41

Table 2-43 Stand-Alone Dehumidifiers Energy Efficient Integrated Energy Factor

Product Capacity (pints/day)	Integrated Energy Factor (liters/kWh)
≤ 25.00	≥1.57
25.01 to 50.00	≥1.80
≥50.01	≥3.30

Table 2-44 Whole-House Dehumidifiers Energy Efficient Integrated Energy Factor

Product Case Volume (ft ³)	Integrated Energy Factor (liters/kWh)
≤ 8.0	≥2.09
> 8.0	≥3.30

Peak Factors

Table 2-45 Peak Factors

Peak Factor	Value	Ref
Electric coincidence factor (CF)	0.405	[52]
Natural gas peak day factor (PDF)	N/A	

Measure Life

The effective useful life (EUL) is 12 years[53].

References

- [49] ACEEE, Lauren Mattison and Dave Korn, The Cadmus Group, Inc., "Dehumidifiers: A Major Consumer of Residential Electricity", 2012, <https://www.aceee.org/files/proceedings/2012/data/papers/0193-000291.pdf>
- [50] 10 CFR 430.32(v)(2), January 2023 [https://www.ecfr.gov/current/title-10/chapter-II/subchapter-D/part-430/subpart-C/section-430.32#p-430.32\(v\)\(2\)](https://www.ecfr.gov/current/title-10/chapter-II/subchapter-D/part-430/subpart-C/section-430.32#p-430.32(v)(2))
- [51] ENERGY STAR® Program Requirements Product Specification for Dehumidifiers, Eligibility Criteria Version 5.0, October 2019
- [52] Dehumidifier Metering in PA and Ohio by ADM from 7/17/2013 to 9/22/2013. 31 Units metered. Assumes all non-coincident peaks occur within window and that the average load during this window is representative of the June PJM days as well.
- [53] New York Standard Approach for Estimating Energy Savings from Energy Efficiency Programs (TRM), Version 10, January 2023.

2.1.10 ROOM AIR CONDITIONER

Market	Residential/Multifamily
Baseline Condition	TOS
Baseline	Code
End Use Subcategory	Indoor Environment
Measure Last Reviewed	December 2022

Description

This measure relates to the purchase and installation of a room air conditioner that meets or exceeds the current ENERGY STAR 4.2 efficiency standards. A room air conditioner is powered by a single phase electric current and is an encased assembly designed as a unit for mounting in a window or through the wall. Qualifying units may be cooling only (non-reverse cycle) or provide cooling, heating, and ventilation (reverse-cycle also referred to as a heat pump). Only cooling energy savings are calculated in this measure.

Note that if the AC unit is connected to a network in a way so as to enable it to respond to energy related commands, there is a 5% extra CEER allowance. In these instances, the default efficient CEER would be 0.95 multiplied by the appropriate CEER from Table 2-47.

Baseline Case

The baseline condition is a room AC unit that meets the minimum federal efficiency standards [54] of the combined energy efficiency ratio based on the installed unit size and type.

Efficient Case

The efficient condition is a room air conditioner that meets or exceeds current ENERGY STAR specifications (version 4.2) [55].

Annual Energy Savings Algorithms

Annual Electric Energy Savings

$$\Delta kWh = \frac{Cap}{1,000} \times \left(\frac{1}{CEER_b} - \frac{1}{CEER_q} \right) \times EFLH_c$$

Annual Fuel Savings

$$\Delta Therms = N/A$$

Peak Demand Savings

$$\Delta kW_{Peak} = \frac{Cap}{1,000} \times \left(\frac{1}{CEER_b} - \frac{1}{CEER_q} \right) \times CF$$

Daily Peak Fuel Savings

$$\Delta Therms_{Peak} = N/A$$

Lifetime Energy Savings Algorithms

Lifetime Electric Energy Savings

$$\Delta kWh_{Life} = \Delta kWh \times EUL$$

Lifetime Fuel Savings

$$\Delta Therms_{Life} = N/A$$

Calculation Parameters

Table 2-46 Calculation Parameters

Variable	Description	Value	Units	Ref
ΔkWh	Annual electric energy savings	Calculated	kWh/yr	
ΔkW_{Peak}	Peak Demand Savings	Calculated	kW	
ΔkWh_{Life}	Lifetime electric energy savings	Calculated	kWh	
Cap	Capacity of energy efficient equipment	Site-specific	Btu/hr	
$CEER_q$	Combined Energy Efficiency Ratio of ENERGY STAR unit in Btus per Watt-hour	Site-specific. If unknown, look up in Table 2-47	Btu/Wh	[58]
$CEER_b$	Combined Energy Efficiency Ratio of baseline unit in Btus per Watt-hour	Look up in Table 2-47, if unknown use 11.0 ¹²	Btu/Wh	[54]
$EFLH_c$	Cooling equivalent full-load hours	600	Hours	[60]
1,000	Conversion from W to kW	1,000	W/kW	
CF	Electric coincidence factor	Look up in Table 2-48	N/A	[59]
EUL	Effective useful life	See Measure Life Section	Years	

¹² Default value (11.0) is the CEER value from minimum Federal Standard for the most common room AC type – <8000 capacity range with louvered sides [57]

Table 2-47 Standard and ENERGY STAR CEER Values for Room Air Conditioner

Product Type and Class (Btu/hour)		Federal standard with louvered sides (CEER _b)	Federal standard without louvered sides (CEER _b)	ENERGY STAR with louvered sides (CEER _q)	ENERGY STAR without louvered sides (CEER _q)
Without reverse cycle	<6,000	11.0	10.0	12.1	11.0
	6,000 to 7,999	11.0	10.0	12.1	11.0
	8,000 to 10,999	10.9	9.6	12.0	10.6
	11,000 to 13,999	10.9	9.5	12.0	10.5
	14,000 to 19,999	10.7	9.3	11.8	10.2
	20,000 to 27,999	9.4	9.4	10.3	10.3
	≥28,000	9.0	9.4	9.9	10.3
With reverse cycle	<14,000		9.3		10.2
	≥14,000		8.7		9.6
	<20,000	9.8		10.8	
	≥20,000	9.3		10.2	
Casement-only		9.5		10.5	
Casement slider		10.4		11.4	

Peak Factors

Table 2-48 Peak Factors

Peak Factor	Value	Ref
Electric coincidence factor (CF)	0.31	[59]
Natural gas peak day factor (PDF)	N/A	

Measure Life

The effective useful life (EUL) is 12 years. [56]

References

- [54] Code of Federal Regulations. 2022. Review of Title 10, Chapter II, Subchapter D, Part 430, Subpart C, section 430.32 b) Room Air Conditioners.
<https://www.ecfr.gov/current/title-10/chapter-II/subchapter-D/part-430/subpart-C/section-430.32>

- [55] “ENERGY STAR Program Requirements for Room Air Conditioners -Eligibility Criteria ENERGY STAR ® Program Requirements Product Specification for Room Air Conditioners Eligibility Criteria Draft Version 4.2.” n.d. Accessed January 9, 2023.
https://www.energystar.gov/sites/default/files/asset/document/ENERGY%20STAR%20Draft%20Version%204.2%20Room%20Air%20Conditioners%20Specification_0_0.pdf
- [56] GDS Associates, Inc. 2007. *Review of Energy Efficiency Measures/Programs Reference Document for the ISO Forward Capacity Market (FCM)*. <https://Library.cee1.org>. June 2007.
https://library.cee1.org/system/files/library/8842/CEE_Eval_MeasureLifeStudyLights%2526HVACGDS_1Jun2007.pdf
- [57] NEEP, Mid-Atlantic Technical Reference Manual, V10. pp 70-71., April 2020,
<https://neep.org/sites/default/files/media-files/trmv10.pdf>
- [58] “Room Air Conditioners Key Product Criteria.” n.d. www.energystar.gov. Accessed January 10, 2023.
https://www.energystar.gov/products/heating_cooling/air_conditioning_room/key_product_criteria.
- [59] RLW Analytics. 2008. *Review of Coincidence Factor Study Residential Room Air Conditioners*. Puc.nh.gov. June 2008.
https://www.puc.nh.gov/electric/Monitoring%20and%20Evaluation%20Reports/National%20Grid/124_SPWG%20Room%20%20AC%20Evaluation%20FINALReport%20June%202023%20ver7.pdf.
- [60] VEIC Estimate. Consistent with analysis of PEPCo and LIPA, and conservative relative to ARI.

2.2 APPLIANCE RECYCLING

2.2.1 REFRIGERATOR & FREEZER RECYCLING

Market	Residential
Baseline Condition	ERET
Baseline	Existing
End Use Subcategory	N/A
Measure Last Reviewed	January 2023

Description

In many cases, when a refrigerator or freezer is replaced by a homeowner, the existing unit is retained, sold, or donated for use elsewhere, representing additional load on the grid. This measure covers recycling of the existing, functional equipment, thereby eliminating the consumption associated with that equipment. Refrigerator and freezer recycling programs (also called “bounty” programs) receive energy savings credit for permanently removing inefficient, functional refrigerators and freezers from the electric grid.

This measure covers the recycling of primary (i.e., installed in a kitchen) and secondary¹³ (i.e., installed elsewhere) refrigerators, refrigerator-freezers and freezers. To account for the fact that secondary equipment is occasionally installed and operating for only part of the year, a part-time use adjustment factor has been developed and embedded within the gross savings estimate for secondary units to establish average annual per unit deemed electric savings.

This measure does not cover the recycling of equipment classified by the Code of Federal Regulations as “Compact refrigerator/refrigerator-freezer/freezer”. This refers to any refrigerator, refrigerator-freezer or freezer with a total refrigerated volume of less than 7.75 ft³ (220 liters), where the total refrigerated volume has been determined in accordance with the procedure prescribed in Appendix A (refrigerators and refrigerator-freezers) or B (freezers) of 10 CFR 430 Subpart B.112.

Baseline Case

The savings calculations below apply to recycling of a functioning primary or secondary refrigerator, refrigerator-freezer, or freezer with total refrigerated volume of 7.75 ft³ (220 liters) or more.

Efficient Case

The compliance condition is the recycling of an existing room refrigerator or freezer as defined in the Measure Description section above.

¹³ Secondary refrigerators are spare or backup refrigerators not installed in the kitchen.

Annual Energy Savings Algorithms

Annual Electric Energy Savings

$$\Delta kWh = \left(\frac{\Delta kWh}{unit} \right)$$

Annual Fuel Savings

$$\Delta Therms = N/A$$

Peak Demand Savings

$$\Delta kW_{Peak} = \left(\frac{\Delta kW}{unit} \right)$$

Daily Peak Fuel Savings

$$\Delta Therms_{Peak} = N/A$$

Lifetime Energy Savings Algorithms

Lifetime Electric Energy Savings

$$\Delta kWh_{Life} = \Delta kWh \times EUL$$

Lifetime Fuel Savings

$$\Delta Therms_{Life} = N/A$$

Calculation Parameters

Table 2-49 Calculation Parameters

Variable	Description	Value	Units	Ref
ΔkWh	Annual electric energy savings	Calculated	kWh/yr	
ΔkW_{Peak}	Peak Demand Savings	Calculated	kW	
ΔkWh_{Life}	Lifetime electric energy savings	Calculated	kWh	
$\Delta kWh/unit$	Energy Savings per unit	Look up in Table 2-50	kWh	[62]
$\Delta kW/unit$	Demand Savings per unit	Look up in Table 2-50	kWh	[62]
CF	Electric coincidence factor	Look up in Table 2-51	N/A	
PDF	Gas peak demand factor	Look up in Table 2-51	N/A	
EUL	Effective useful life	See Measure Life Section	Years	[61]

Table 2-50 Default Values for Annual Energy and Peak Demand Savings

	Primary Refrigerator	Secondary Refrigerator	Freezer
Δ kWh/unit	958	581	593
Δ kW/unit	0.15	0.10	0.10

Peak Factors

Table 2-51 Peak Factors

Peak Factor	Value	Ref
Electric coincidence factor (CF)	N/A	
Natural gas peak day factor (PDF)	N/A	

Measure Life

The effective useful life (EUL) is 5 years for a refrigerator and 4 years for a freezer [61].

References

[61] California Public Utilities Commission Database for Energy Efficient Resources (DEER) EUL Support Table for 2020, <http://www.deeresources.com/files/DEER2020/download/SupportTable-EUL2020.xlsx>

[62] DNV, Appliance Recycling Program Impact Evaluation Study, June 2021

<https://documents.dps.ny.gov/public/Common/ViewDoc.aspx?DocRefId=%7BE846898E-5EAE-4F42-9F97-385982740AC6%7D>

2.2.2 ROOM AC UNIT RECYCLING

Market	Residential
Baseline Condition	ERET
Baseline	Existing
End Use Subcategory	Recycling
Measure Last Reviewed	January 2023

Description

This measure describes the savings resulting from implementing a drop off service taking existing working inefficient Room Air Conditioner units from service, prior to their natural end of life. Like the Refrigerator Early Retirement / Recycling measure, this measure quantifies savings associated with the removal of room air conditioner units from service (rather than transferred to another location in the home or another household) and thus does not decrement savings due to retired units that are replaced in participants' homes. A room air conditioner is an appliance, other than a "packaged terminal air conditioner," which is powered by a single-phase electric current and that is an encased assembly designed as a unit for mounting in a window or through the wall for the purpose of providing delivery of conditioned air to an enclosed space.

Baseline Case

The baseline condition is the existing inefficient room air conditioning unit.

Efficient Case

The existing room air conditioning unit is removed from service and dismantled/recycled.

Annual Energy Savings Algorithms

Annual Electric Energy Savings

$$\Delta kWh = \frac{Hrs \times Btuh \times (1/EE_{R_{exist}})}{1,000} \times Part\ Use\ Factor$$

Annual Fuel Savings

$$\Delta Therms = N/A$$

Peak Demand Savings

$$\Delta kW_{Peak} = \frac{\Delta kWh}{Hrs} \times CF$$

Daily Peak Fuel Savings

$$\Delta Therms_{Peak} = N/A$$

Lifetime Energy Savings Algorithms

Lifetime Electric Energy Savings

$$\Delta kWh_{Life} = \Delta kWh \times EUL$$

Lifetime Fuel Savings

$$\Delta Therms_{Life} = N/A$$

Calculation Parameters

Table 2-52 Calculation Parameters

Variable	Description	Value	Units	Ref
ΔkWh	Annual electric energy savings	Calculated	kWh/yr	
ΔkW_{Peak}	Peak Demand Savings	Calculated	kW	
ΔkWh_{Life}	Lifetime electric energy savings	Calculated	kWh	
Hrs	Run hours of window AC unit	600	Hours	[60]
Btuh	Capacity of replaced unit	Site-specific, if unknown assume 7,829	Btu/hr	[65]
EER_{exist}	Efficiency of existing unit	Site-specific, if unknown assume 9.8	Btu/W/hr	[66]
Part Use Factor	Fraction of those units that are not in daily use throughout the entire cooling season as reported by the participant	Site-specific, if unknown use 0.34	N/A	[68]
CF	Electric coincidence factor	Look up in Table 2-53	N/A	
PDF	Gas peak day factor	Look up in Table 2-53	N/A	
EUL	Effective useful life	See Measure Life Section	Years	

Peak Factors

Table 2-53 Peak Factors

Peak Factor	Value	Ref
Electric coincidence factor (CF)	0.3	[67]
Natural gas peak day factor (PDF)	N/A	

Measure Life

The effective useful life (EUL) is 3 years. [63]

References

- [63] California Public Utilities Commission Database for Energy Efficient Resources (DEER) EUL Support Table for 2020, <http://www.deeresources.com/files/DEER2020/download/SupportTable-EUL2020.xlsx> .
- [64] VEIC Estimate. Consistent with analysis of PEPCo and LIPA, and conservative relative to ARI.
- [65] RLW Report: Final Report Coincidence Factor Study Residential Room Air Conditioners (June 23, 2008 p. 22), based on population average.
https://www.puc.nh.gov/electric/Monitoring%20and%20Evaluation%20Reports/National%20Grid/124_SPWG%20Room%20%20AC%20Evaluation%20FINALReport%20June%2023%20ver7.pdf
- [66] Minimum Federal Standard for most common room AC type (8000-14,999 capacity range with louvered sides) per federal standards from 10/1/2000 to 5/31/2014.
- [67] RLW Report: Final Report Coincidence Factor Study Residential Room Air Conditioners (June 23, 2008 p. 32), CF value for Hartford, CT.
https://www.puc.nh.gov/electric/Monitoring%20and%20Evaluation%20Reports/National%20Grid/124_SPWG%20Room%20%20AC%20Evaluation%20FINALReport%20June%2023%20ver7.pdf
- [68] Source: Cadmus analysis, EmPOWER 2018 P1 & P2 ARP participant survey

2.2.3 DEHUMIDIFIER RECYCLING

Market	Residential
Baseline Condition	ERET
Baseline	Existing
End Use Subcategory	Dehumidifier
Measure Last Reviewed	January 2023

Description

In many cases, when homeowner replaces a dehumidifier, the existing unit is retained, sold, or donated for use elsewhere, representing additional load on the grid. This measure covers recycling of existing, functional, portable dehumidifiers, thereby eliminating the consumption associated with that equipment. This measure should target, but not be limited to, dehumidifiers put into service prior to June 2019. If provided data indicate the unit is replaced rather than retired, savings shall be based on the Residential Dehumidifier measure in this TRM.

Baseline Case

The baseline condition is the existing dehumidifier in working condition.

Efficient Case

The existing dehumidifier is removed from service and not replaced.

Annual Energy Savings Algorithms

Annual Electric Energy Savings

$$\Delta kWh = capacity \times \frac{0.473}{24} \times hrs \times \frac{1}{L/kWh}$$

Annual Fuel Savings

$$\Delta Therms = N/A$$

Peak Demand Savings

$$\Delta kW_{Peak} = \frac{\Delta kWh}{hrs} \times CF$$

Daily Peak Fuel Savings

$$\Delta Therms_{Peak} = N/A$$

Lifetime Energy Savings Algorithms

Lifetime Electric Energy Savings

$$\Delta kWh_{Life} = \Delta kWh \times RUL$$

Lifetime Fuel Savings

$$\Delta Therms_{Life} = N/A$$

Calculation Parameters

Table 2-54 Calculation Parameters

Variable	Description	Value	Units	Ref
ΔkWh	Annual electric energy savings	Calculated	kWh/yr	
ΔkW_{Peak}	Peak Demand Savings	Calculated	kW	
ΔkWh_{Life}	Lifetime electric energy savings	Calculated	kWh	
Capacity	Capacity of the unit	Site-specific. If unknown, use 56 pints/day	pints/day	
L/kWh	Dehumidifier Efficiency in liters (L) of water removed per kWh	Lookup in Table 2-55	L/kWh	[71][72][73]
0.473	Conversion factor	0.473	L/pint	
24	Conversion factor	24	Hr/day	
Hrs	Hours of use ¹⁴	Site-specific. If unknown use 1,632	Hours/yr	[70]
CF	Electric coincidence factor	Lookup in Table 2-55	N/A	
PDF	Gas peak day factor	Lookup in Table 2-55	N/A	
RUL	Remaining useful life	See Measure Life Section	Years	[69]

Table 2-55 Dehumidifier Capacity and Efficiency

Capacity Range (pints/day)	ENERGY STAR Labeled (L/kWh)	Non-ENERGY STAR Labeled	
		Manufacture date before Oct. 2012 ($\geq L/kWh$)	Manufacture date of Oct. 2012 or later ($\geq L/kWh$)
≤ 25	1.57	1.00	1.35
>25 to ≤ 35	1.80	1.20	1.35
>35 to ≤ 45	1.80	1.30	1.50

¹⁴ Default run hour assumption based on 68 days per year, 24 hours of use. [70]

Capacity Range (pints/day)	ENERGY STAR Labeled (L/kWh)	Non-ENERGY STAR Labeled	
		Manufacture date before Oct. 2012 (\geq L/kWh)	Manufacture date of Oct. 2012 or later (\geq L/kWh)
>45 to \leq 50	1.80	1.30	1.60
>50 to \leq 55	3.30	1.30	1.60
>54 to \leq 75	3.30	1.50	1.70
>75 to \leq 185	3.30	2.25	2.50

Peak Factors

Table 2-56 Peak Factors

Peak Factor	Value	Ref
Electric coincidence factor (CF)	0.37 ¹⁵	[70]
Natural gas peak day factor (PDF)	N/A	

Measure Life

The remaining useful life (RUL) is 4 years[69].

References

- [69] CA DEER gives the following rule-of-thumb for remaining useful life: $RUL = (1/3) \times EUL$. As the Energy Star Dehumidifier [replacement] uses an EUL of 12 years, we have a suggested RUL of $(1/3) \times 12$ years = 4 years.
- [70] Savings Calculator for ENERGY STAR® Qualified Appliances Version 3.0 Last Updated October 1, 2012.
- [71] ENERGY STAR® Program Requirements for Dehumidifiers, Version 5.0, February 2019.
- [72] 42 U.S.C, Title 42 Chapter 77, Subchapter III, Part A, (cc)(1) and (cc)(2).
<https://uscode.house.gov/view.xhtml?path=/prelim@title42/chapter77/subchapter3&edition=prelim>
- [73] Code of Federal Regulations Title 10, Chapter 2, Subchapter D, Part 430, Subpart C (v)(1).
<https://www.ecfr.gov/current/title-10/chapter-II/subchapter-D/part-430/subpart-C>

¹⁵ Assume usage is evenly distributed day vs. night, weekend vs. weekday and is used between April through the end of September (4392 possible hours). 1632 operating hours from ENERGY STAR Dehumidifier Calculator. Coincidence peak during summer peak is therefore $1632/4392 = 37.2\%$, [70]

2.3 HVAC

2.3.1 CENTRAL AC, ASHP, MINI-SPLITS, PTAC, PTHP

Market	Residential/Multifamily
Baseline Condition	TOS/NC/EREP/DI
Baseline	Code/Dual
End Use Subcategory	Equipment
Measure Last Reviewed	January 2023

Description

This prescriptive measure targets the use of central air conditioners, air source heat pumps, mini split heat pumps and ACs, packaged terminal systems (PTAC and PTHP) in residential and multi-family low-rise applications as further described below. This measure may apply to early replacement of an existing system, replacement on burnout, or installation of a new unit in a new or existing residential or multi-family low-rise building for HVAC applications.

The algorithms also include the calculation of additional energy and demand savings due to the proper sizing of high efficiency units.

Baseline Case

For whole building new construction, the baseline equipment is an industry standard equipment type for the facility compliant with IECC 2021 for single family and multi-family low-rise residential buildings (see Appendix E: Code-Compliant Efficiencies). For multi-family high-rise residential buildings, refer to the algorithms in Commercial and Industrial Section.

For replacement of failed equipment, or end of useful life, the baseline would be a minimally code compliant version of the replaced system type and fuel

For early replacement projects, use dual baselines:

- For the remaining useful life (RUL) of the existing equipment, the baseline is the actual existing equipment. In the lifetime algorithms section, annual savings for this period are designated as kWh_{ex} and Therms_{ex}. If the site specific efficiency of the existing equipment is unknown, use the equipment efficiency from the IECC version in force when the equipment was new (if equipment vintage is unknown, use IECC 2012 efficiency requirements from Appendix E: Code-Compliant Efficiencies).
- For the duration of the measure life after the end of the RUL, the baseline is a code-compliant version of the replaced equipment. In the lifetime algorithms section, annual savings for this period are designated as kWh_{NR} and Therms_{NR}.

Efficient Case

A central air conditioner, air source heat pump, mini split AC, mini split heat pump, or packaged terminal system (PTAC and PTHP) that exceeds code requirements.

Annual Energy Savings Algorithms

Annual Electric Energy Savings

$$\Delta kWh = kWh_b - kWh_q + PSF \times kWh_{c,q}$$

Where,

$$kWh_b = OSF \times kWh_{c,b} + kWh_{h,b}$$

$$kWh_q = OSF \times kWh_{c,q} + kWh_{h,q}$$

Calculate $kWh_{c,b}$ and $kWh_{h,b}$ using the algorithms in Table 2-57 for the appropriate baseline equipment type. Calculate $kWh_{c,q}$ and $kWh_{h,q}$ using the algorithms in Table 2-58 for the appropriate efficient equipment type.

Table 2-57 Baseline Energy Consumption Equations

Baseline Equipment	Baseline Cooling kWh ($kWh_{c,b}$)	Baseline Heating kWh ($kWh_{h,b}$)
Mini-split heat pump, ASHP (Cooling Capacity < 65 kBtu/h)	$\frac{Cap}{SEER_b \times 1,000} \times EFLH_c$	$\frac{Cap_h}{HSPF_b \times 1,000} \times EFLH_h$
Mini-split AC, Air Conditioner (Cooling Capacity < 65 kBtu/h)	$\frac{Cap_c}{SEER_b \times 1,000} \times EFLH_c$	0
PTAC	$\frac{Cap_c}{EER_b \times 1,000} \times EFLH_c$	0
PTHP	$\frac{Cap_c}{EER_b \times 1,000} \times EFLH_c$	$\frac{Cap_h}{COP_b \times 3.412 \times 1,000} \times EFLH_h$
Electric Resistance heating	0	$\frac{Cap_h}{HSPF_b \times 1,000} \times EFLH_h$
Room Air Conditioner	$\frac{Cap_c}{CEER_b \times 1,000} \times EFLH_c$	0

Table 2-58 Energy Efficient Energy Consumption Equations

Qualifying Equipment	Efficient Cooling kWh ($kWh_{c,q}$)	Efficient Heating kWh ($kWh_{h,q}$)
Mini-split heat pump, ASHP (Cooling Capacity < 65 kBtu/h)	$\frac{Cap_c}{SEER_q \times 1,000} \times EFLH_c$	$\frac{Cap_h}{HSPF_q \times 1,000} \times EFLH_h$
Mini-split AC, Central Air Conditioner (Cooling Capacity < 65 kBtu/h)	$\frac{Cap_c}{SEER_q \times 1,000} \times EFLH_c$	0
PTAC	$\frac{Cap_c}{EER_q \times 1,000} \times EFLH_c$	0
PTHP	$\frac{Cap_c}{EER_q \times 1,000} \times EFLH_c$	$\frac{Cap_h}{COP_q \times 3.412 \times 1,000} \times EFLH_h$

Annual Fuel Savings

$$\Delta Therms = Therms_b - Therms_q$$

Where,

$Therms_b$ = see Table 2-59 for appropriate baseline equipment type

$$Therms_q = 0$$

Table 2-59 Baseline Fuel Consumption

Baseline Equipment	Baseline fuel consumption (Therms _b)
Gas Fired Furnace/Boiler	$\frac{Cap_h}{Eff_{b,fuel} \times 100,000} \times EFLH_h$
Electric resistance heating	0

Peak Demand Savings

$$\Delta kW_{Peak} = Cap_c \times \frac{1}{1,000} \times \left(\frac{1}{EER_b} - \frac{1}{EER_q} \right) \times CF$$

Daily Peak Fuel Savings

$$\Delta Therms_{Peak} = \Delta Therms \times PDF$$

Lifetime Energy Savings Algorithms

Lifetime Electric Energy Savings

No dual baseline:

$$\Delta kWh_{Life} = \Delta kWh \times EUL$$

Dual baseline:

$$\Delta kWh_{Life} = \Delta kWh_{Ex} \times RUL + \Delta kWh_{NR} \times (EUL - RUL)$$

Where,

ΔkWh_{Ex} = annual energy savings calculated as above, using actual existing equipment baseline

ΔkWh_{NR} = annual energy savings calculated as above, using code baseline

Lifetime Fuel Savings

No dual baseline:

$$\Delta Therms_{Life} = \Delta Therms \times EUL$$

Dual baseline:

$$\Delta Therms_{Life} = \Delta Therms_{Ex} \times RUL + \Delta Therms_{SNR} \times (EUL - RUL)$$

Where,

$\Delta Therms_{Ex}$ = annual fuel savings calculated as above, using actual existing equipment baseline

$\Delta Therms_{SNR}$ = annual fuel savings calculated as above, using code baseline

Calculation Parameters

Table 2-60 Calculation Parameters

Variable	Description	Value	Units	Ref
ΔkWh	Annual electric energy savings	Calculated	kWh/yr	
$\Delta Therms$	Annual fuel savings	Calculated	Therms/yr	
ΔkW_{Peak}	Peak Demand Savings	Calculated	kW	
$\Delta Therms_{Peak}$	Daily peak fuel savings	Calculated	Therms/day	
ΔkWh_{Life}	Lifetime electric energy savings	Calculated	kWh	
$\Delta Therms_{Life}$	Lifetime fuel savings	Calculated	Therms	
kWh_b	Baseline electrical consumption	Calculated	kWh/yr	
kWh_q	Energy efficient electrical consumption	Calculated	kWh/yr	
Cap_c	Cooling capacity of installed unit	Site-specific	Btu/hr	
Cap_h	Heating capacity of installed unit	Site-specific	Btu/hr	
$SEER_q$	SEER of installed unit	Site-specific	Btu/W-h	
$IEER_q$	IEER of qualifying unit	Site-specific	Btu/W-h	
EER_q	EER of qualifying unit	Site-specific	Btu/W-h	
COP_q	Coefficient of performance of the qualifying unit at 47F	Site-specific	N/A	
$HSPF_q$	Heating seasonal performance factor of the installed unit	Site-specific	Btu/W-h	
$SEER_b$	SEER of baseline unit	Site-specific or lookup in Appendix E: Code-Compliant Efficiencies	Btu/W-h	[433][435][128][154]
$IEER_b$	IEER of baseline unit	Site-specific or lookup in Appendix E: Code-Compliant Efficiencies	Btu/W-h	[433][435][128][154]

Variable	Description	Value	Units	Ref
EER _b	EER of baseline unit	Site-specific or lookup in Appendix E: Code-Compliant Efficiencies	Btu/W-h	[433][435][128][154]
HSPF _b	Heating seasonal performance factor of the baseline unit	Site-specific or lookup in Appendix E: Code-Compliant Efficiencies. For electric resistance heat, use 3.412	Btu/W-h	[433][435][128][154]
CEER _b	Combined Energy Efficiency Ratio of baseline room air conditioner ¹⁶	Use federal standard values in Appendix E: Code-Compliant Efficiencies, if unknown, use 11.0	Btu/W-h	[54]
Eff _{b,fuel}	Efficiency of baseline boiler/furnace	Site-specific or look up in Appendix E: Code-Compliant Efficiencies	N/A	[433][435][81]
OSF	Oversize derating factor ¹⁷	Site-specific, if unknown use 0.8	N/A	
PSF	Proper sizing factor	Not properly sized or properly sized baseline equipment: 0 Properly sized: 0.05	N/A	[79]
kWh _{c,b}	Baseline cooling electrical consumption	Calculated from Table 2-57	kWh/yr	
kWh _{h,b}	Baseline heating electrical consumption	Calculated from Table 2-57	kWh/yr	
kWh _{c,q}	Energy efficient cooling electrical consumption	Calculated from Table 2-58	kWh/yr	
kWh _{h,q}	Energy efficient heating electrical consumption	Calculated from Table 2-58	kWh/yr	
Therms _b	Baseline fuel consumption	Calculated from Table 2-57	Therms/yr	
Therms _q	Energy efficient fuel consumption	0	Therms/yr	
EFLH _c	Equivalent Full Load Hours of operation for the average unit during the cooling season	Lookup in Appendix C: Heating and Cooling EFLH	Hours	[76]

¹⁶ Default value (11.0) is the CEER value from minimum Federal Standard for the most common room AC type – <8000 capacity range with louvered sides

¹⁷ Heat pump systems may be sized to meet the peak heating load and will be oversized for cooling. The cooling EFLH assumes a nominal 20% oversizing. This derating factor has been added to account for the oversizing of heat pump cooling capacity when the unit is sized based on heating capacity. A user with a more accurate estimation of the oversizing can use a different factor than the one mentioned above to account for oversizing.

Variable	Description	Value	Units	Ref
EFLH _h	Equivalent Full Load Hours of operation for the average unit during the heating season	Lookup in Appendix C: Heating and Cooling EFLH	Hours	[76]
COP _b	Coefficient of performance of the baseline unit at 47F	Site-specific or lookup in Appendix E: Code-Compliant Efficiencies	N/A	[433][435][128][154]
1,000	Conversion from W to kW	1,000	W/kW	
3.412	Conversion factor from kWh to kBtu	3.412	kBtu/kWh	
CF	Cooling coincidence factor	Lookup in Table 3-132	N/A	[80]
PDF	Gas peak day factor	Lookup in Table 3-132	N/A	
EUL	Effective useful life	See Measure Life section	Years	[438]

Peak Factors

Table 2-61 Peak Factors

Peak Factor	Value	Ref
Electric coincidence factor (CF)	0.69	[80]
Natural gas peak day factor (PDF)	See Appendix G: Natural Gas Peak Day Factors	

Measure Life

The remaining useful life (RUL) for existing equipment is limited to 1/3 of the effective useful life (EUL) of the equipment.

Table 2-62 Measure Life

Equipment	EUL	RUL	Ref
Central A/C	15	5	[438]
Air source heat pump	15	5	[438]
Mini split heat pump	15	5	[438]
PTAC/PTHP	15	5	[438]

References

[74] ASHRAE Standard 90.1-2019, Energy Standard for Buildings Except Low-Rise Residential Buildings. (ASHRAE, 2019), Table 6.8.1-5, <https://www.ashrae.org/technical-resources/standards-and-guidelines/read-only-versions-of-ashrae-standards>

- [75] ASHRAE Standard 90.1-2013, Energy Standard for Buildings Except Low-Rise Residential Buildings. (ASHRAE, 2019), Table 6.8.1-5, <https://www.ashrae.org/technical-resources/standards-and-guidelines/read-only-versions-of-ashrae-standards>
- [76] 2021 PA TRM Vol 1: General Information, Pg 19 Table 1-8
- [77] C&I Unitary HVAC Load Shape Project Final Report. August 2011, v.1.1, p. 12, Table O-5. The CF reported here is a center point for NJ chosen between the CF for urban NY and for the Mid-Atlantic region in the PJM peak periods.
- [78] California Public Utilities Commission Database for Energy Efficient Resources (DEER) EUL Support Table for 2020, <http://www.deeresources.com/files/DEER2020/download/SupportTable-EUL2020.xlsx>
- [79] ENERGY STAR® HVAC QUALITY INSTALLATION PROGRAM A new approach to residential HVAC efficiency and performance. Pg 2, https://www.energystar.gov/ia/home_improvement/downloads/ESQI_factsheet.pdf?07d7-31fc
- [80] NEEP, *Mid-Atlantic Technical Reference Manual*, V9. (October 2019). Pg 95
<https://neep.org/sites/default/files/resources/Mid Atlantic TRM V9 Final clean wUpdateSummary%20-%20CT%20FORMAT.pdf>
- [81] Code of Federal Regulations. 2022. Review of Title 10, Chapter II, Subchapter D, Part 430 eCFR. December 1, 2022. <https://www.ecfr.gov/current/title-10/chapter-II/subchapter-D/part-430>
- [82] VEIC Estimate. Consistent with analysis of PEPCo and LIPA, and conservative relative to ARI.
- [83] “2021 INTERNATIONAL ENERGY CONSERVATION CODE (IECC) | ICC DIGITAL CODES.” n.d. Codes.iccsafe.org. Accessed November 16, 2022. <https://codes.iccsafe.org/content/IECC2021P2/chapter-4-ce-commercial-energy-efficiency>.
- [84] “2012 INTERNATIONAL ENERGY CONSERVATION CODE (IECC) | ICC DIGITAL CODES.” n.d. Codes.iccsafe.org. Accessed January 23, 2023 <https://codes.iccsafe.org/content/IECC2012P5/chapter-4-ce-commercial-energy-efficiency>
- [85] Code of Federal Regulations. 2022. Review of Title 10, Chapter II, Subchapter D, Part 430, Subpart C, section 430.32 b) Room Air Conditioners,

2.3.2 GROUND LOOP AND AIR-TO-WATER HEAT PUMP

Market	Residential/Multifamily
Baseline Condition	TOS/NC/EREP
Baseline	Code/Dual
End Use Subcategory	Equipment
Measure Last Reviewed	January 2023

Description

This prescriptive measure targets the use of ground loop and air-to-water heat pumps in residential and multi-family low-rise applications as further described below. This measure may apply to early replacement of an existing system, replacement on burnout, or installation of a new unit in a new or existing residential or low-rise residential building for HVAC applications.

Baseline Case

For whole building new construction, the baseline equipment is an industry standard equipment type for the facility compliant with IECC 2021. For multi-family high-rise residential buildings, refer to the algorithms in Commercial and Industrial Section.

For replacement of failed equipment, or end of useful life, the baseline would be a minimally code compliant version of the replaced system type and fuel

For early replacement projects, use dual baselines:

- For the remaining useful life (RUL) of the existing equipment, the baseline is the actual existing equipment. In the lifetime algorithms section, annual savings for this period are designated as kWh_{ex} and Therms_{ex}. If the site specific efficiency of the existing equipment is unknown, use the equipment efficiency from the IECC version in force when the equipment was new (if equipment vintage is unknown, use IECC 2012).
- For the duration of the measure life after the end of the RUL, the baseline is a code-compliant version of the replaced equipment. In the lifetime algorithms section, annual savings for this period are designated as kWh_{NR} and Therms_{NR}.

Efficient Case

A ground loop and air-to-water heat pump that meets or exceeds code

Annual Energy Savings Algorithms

Annual Electric Energy Savings

$$\Delta kWh = kWh_b - kWh_q + PSF \times kWh_{c,q}$$

Where,

$$kWh_b = OSF_b \times kWh_{c,b} + kWh_{h,b} + kWh_{p,b}$$

$$kWh_q = OSF_q \times kWh_{c,q} + kWh_{h,q} + kWh_{p,q}$$

Calculate kWh_{c,b}, kWh_{h,b}, and kWh_{p,b} using the algorithms in Table 2-63 for the appropriate baseline equipment type.

Calculate kWh_{c,q}, kWh_{h,q}, and kWh_{p,q} using the algorithms in Table 2-63 for the appropriate efficient equipment type.

Table 2-63 Baseline Energy Consumption Equations

Baseline Equipment	Baseline Cooling kWh (kWh _{c,b})	Baseline Heating kWh (kWh _{h,b})	Baseline Circulating Pump kWh (kWh _{p,b})
ASHP (Cooling Capacity < 65 kBtu/h)	$\frac{Cap_c}{SEER_b \times 1,000} \times EFLH_c$	$\frac{Cap_h}{HSPF_b \times 1,000} \times EFLH_h$	0
GSHP (Cooling Capacity < 65 kBtu/h)	$\frac{Cap_c \times EFLH_c}{GSEER \times EER_b \times 1,000}$	$\frac{Cap_h \times EFLH_h}{COP_b \times 3.412 \times 1,000}$	$\frac{0.746 \times HP_b \times LF}{Eff_b} \times Hr$
GSHP (Cooling Capacity > 65 kBtu/h)	$\frac{Cap_c}{EER_b \times 1,000} \times EFLH_c$	$\frac{Cap_h}{COP_b \times 3.412 \times 1,000} \times EFLH_h$	$\frac{0.746 \times HP_b \times LF}{Eff_b} \times Hr$
DX A/C (Cooling Capacity < 65 kBtu/h)	$\frac{Cap_c}{SEER_b \times 1,000} \times EFLH_c$	0	0
DX A/C (Cooling Capacity > 65 kBtu/h)	$\frac{Cap_c}{IEER_b \times 1,000} \times EFLH_c$	0	0
Electric Resistance heating	0	$\frac{Cap_h}{3.412 \times 1,000} \times EFLH_h$	0

Table 2-64 Energy Efficient Energy Consumption Equations

Qualifying Equipment	Efficient Cooling kWh (kWh _{c,q})	Efficient Heating kWh (kWh _{h,q})	Efficient Circulating Pump kWh (kWh _{p,q})
Water to air ground water heat pumps	$\frac{Cap_c}{EER_q \times 1,000} \times EFLH_c$	$\frac{Cap_h}{COP_q \times 3.412 \times 1,000} \times EFLH_h$	$\frac{0.746 \times HP_q \times LF}{Eff_{motor,q}} \times Hr$
Brine to air ground loop heat pump (Cooling Capacity < 65 kBtu/h)	$\frac{Cap_c \times EFLH_c}{GSEER \times EER_q \times 1,000}$	$\frac{Cap_{h,q} \times EFLH_h}{COP_q \times 3.412 \times 1,000}$	$\frac{0.746 \times HP_q \times LF}{Eff_{motor,q}} \times Hr$
Brine to air ground loop heat pump (Cooling Capacity > 65 kBtu/h)	$\frac{Cap_c}{EER_q \times 1,000} \times EFLH_c$	$\frac{Cap_h}{COP_q \times 3.412 \times 1,000} \times EFLH_h$	$\frac{0.746 \times HP_q \times LF}{Eff_{motor,q}} \times Hr$

Annual Fuel Savings

$$\Delta Therms = Therms_b - Therms_q$$

Where,

$Therms_b = \text{see Table 3-106 for appropriate baseline equipment type}$

$Therms_q = 0$ (If the unit uses a furnace backup, use equation from Table 1-3)

Table 2-65 Baseline Fuel Consumption

Baseline Equipment	Baseline fuel consumption (Therms _b)
ASHP, WSHP, GSHP	0
Gas Fired Furnace/Boiler	$\frac{Cap_h}{Eff_{b,fuel} \times 100,000} \times EFLH_h$
Electric resistance heating	0

Peak Demand Savings

$$\Delta kW_{peak} = Cap_c \times \frac{1}{1,000} \left(\left(\frac{1}{EER_b} \times \frac{1}{GSPK_b} \right) - \left(\frac{1}{EER_q} \times \frac{1}{GSPK_q} \right) \right) \times CF$$

Daily Peak Fuel Savings

$$\Delta Therms_{peak} = \Delta Therms \times PDF$$

Lifetime Energy Savings Algorithms

Lifetime Electric Energy Savings

No dual baseline:

$$\Delta kWh_{Life} = \Delta kWh \times EUL$$

Dual baseline:

$$\Delta kWh_{Life} = \Delta kWh_{Ex} \times RUL + \Delta kWh_{NR} \times (EUL - RUL)$$

Where,

ΔkWh_{Ex} = annual energy savings calculated as above, using actual existing equipment baseline

ΔkWh_{NR} = annual energy savings calculated as above, using code baseline

Lifetime Fuel Savings

No dual baseline:

$$\Delta Therms_{Life} = \Delta Therms \times EUL$$

Dual baseline:

$$\Delta Therms_{Life} = \Delta Therms_{Ex} \times RUL + \Delta Therms_{SNR} \times (EUL - RUL)$$

Where,

$\Delta Therms_{Ex}$ = annual fuel savings calculated as above, using actual existing equipment baseline

$\Delta Therms_{SNR}$ = annual fuel savings calculated as above, using code baseline

Calculation Parameters

Table 2-66 Calculation Parameters

Variable	Description	Value	Units	Ref
ΔkWh	Annual electric energy savings	Calculated	kWh/yr	
$\Delta Therms$	Annual fuel savings	Calculated	Therms/yr	
ΔkW_{Peak}	Peak Demand Savings	Calculated	kW	
$\Delta Therms_{Peak}$	Daily peak fuel savings	Calculated	Therms/day	
ΔkWh_{Life}	Lifetime electric energy savings	Calculated	kWh	
$\Delta Therms_{Life}$	Lifetime fuel savings	Calculated	Therms	
kWh_b	Baseline electrical consumption	Calculated	kWh/yr	
kWh_q	Energy efficient electrical consumption	Calculated	kWh/yr	
Cap_c	Cooling capacity of installed unit	Site-specific	Btu/hr	
Cap_h	Heating capacity of installed unit	Site-specific	Btu/hr	
EER_q	EER of qualifying unit	Site-specific	Btu/W-h	
COP_q	Coefficient of performance of the qualifying unit	Site-specific	N/A	
HP_q	Horsepower of qualifying ground/water loop circulating pump motor	Site-specific	HP	
HP_b	Horsepower of base case ground/water loop circulating pump motor	Site-specific, if unknown use HP_q	HP	
$SEER_b$	SEER of baseline unit	Site-specific or lookup in Appendix E: Code-Compliant Efficiencies	Btu/W-h	[233][447][128][154]

Variable	Description	Value	Units	Ref
IEER _b	IEER of baseline unit	Site-specific or lookup in Appendix E: Code-Compliant Efficiencies	Btu/W-h	[233][447][128][154]
EER _b	EER of baseline unit	Site-specific or lookup in Appendix E: Code-Compliant Efficiencies	Btu/W-h	[233][447][128][154]
HSPF _b	Heating seasonal performance factor of the baseline unit	Site-specific, if unknown lookup in Appendix E: Code-Compliant Efficiencies. For electric resistance heat, use 3.412	Btu/W-h	[233][447][128][154]
Eff _{motor,b}	Efficiency of base case ground/water loop circulating pump motor	Site-specific, if unknown lookup in Table 3-108	N/A	[93]
Eff _{motor,q}	Efficiency of qualifying ground/water loop circulating pump motor	Site-specific, if unknown lookup in 10 CFR 430.32 (c)(1) , December 2022.	N/A	[93]
Eff _{b,fuel}	Efficiency of baseline boiler/furnace	Site-specific or look up in Appendix E: Code-Compliant Efficiencies	N/A	[233][447]
PSF	Proper sizing factor	Not properly sized or properly sized baseline equipment: 0 Properly sized: 0.05	N/A	[100]
OSF _b	Baseline oversize derating factor	Site-specific, if unknown use 0.8 ¹⁸	N/A	
OSF _q	Qualifying unit oversize derating factor	Site-specific, if unknown use 0.8 ¹	N/A	
kWh _{c,b}	Baseline cooling electrical consumption	Calculated from Table 2-63	kWh/yr	
kWh _{h,b}	Baseline heating electrical consumption	Calculated from Table 2-63	kWh/yr	
kWh _{p,b}	Baseline pump electrical consumption	Calculated from Table 2-63	kWh/yr	
kWh _{c,q}	Energy efficient cooling electrical consumption	Calculated from Table 2-64	kWh/yr	

¹⁸ Heat pump systems are generally sized to meet the peak heating load and are oversized for cooling. The cooling EFLH assumes a nominal 20% oversizing. This derating factor has been added to account for the oversizing of the heat pump in cooling model relative to the standard assumption of 20% embedded in the EFLH data. A user with a more accurate estimation of the oversizing can use a different factor than the one mentioned above to account for oversizing.

Variable	Description	Value	Units	Ref
kWh _{h,q}	Energy efficient heating electrical consumption	Calculated from Table 2-64	kWh/yr	
kWh _{p,q}	Energy efficient pump electrical consumption	Calculated from Table 2-64	kWh/yr	
Therms _b	Baseline fuel consumption	Lookup in Table 3-106	Therms/yr	
Therms _q	Energy efficient fuel consumption	0	Therms/yr	
EFLH _c	Equivalent Full Load Hours of operation for the average unit during the cooling season	600	Hours	[82]
EFLH _h	Equivalent Full Load Hours of operation for the average unit during the heating season	965	Hours	[97]
COP _b	Coefficient of performance of the baseline unit	Lookup in Appendix E: Code-Compliant Efficiencies	N/A	[233][447][128][154]
GSER	Factor used to determine the seasonal efficiency of a GSHP based on its EER	1.02	N/A	[441]
GSPK _b	Factor to convert EER of GSHP to the equivalent EER of an air conditioner	Non GSHP Baseline:1 GSHP:0.8416	N/A	[87]
GSPK _q	Factor to convert EER of GSHP to the equivalent EER of an air conditioner	0.8416	N/A	[87]
1,000	Conversion from W to kW	1,000	W/kW	
3.412	Conversion factor from kWh to kBtu	3.412	kBtu/kWh	
0.746	Conversion from HP to kW	0.746	kW/hp	
LF	Load factor of pump motor	0.75	N/A	[442]
Hrs	Operating hours of pump motor	Look up in Appendix D: HVAC Fan and Pump Operating Hours	Hours	
CF _c	Cooling coincidence factor	Lookup in Table 3-132	N/A	
CF _{pump}	Pump coincidence factor	Lookup in Table 3-132	N/A	
PDF	Gas peak day factor	Lookup in Table 3-132	N/A	
EUL	Effective useful life	See Measure Lifesection	Years	
RUL	Remaining useful life	See Measure Life section	Years	

Table 2-67 Federal Baseline Motor Efficiencies

Motor HP	Motor Nominal Full-Load Efficiencies (percent)							
	2 Poles		4 Poles		6 Poles		8 Poles	
	Enclosed	Open	Enclosed	Open	Enclosed	Open	Enclosed	Open
1	77.0	77.0	85.5	85.5	82.5	82.5	75.5	75.5
1.5	84.0	84.0	86.5	86.5	87.5	86.5	78.5	77.0
2	85.5	85.5	86.5	86.5	88.5	87.5	84.0	86.5
3	86.5	85.5	89.5	89.5	89.5	88.5	85.5	87.5
5	88.5	86.5	89.5	89.5	89.5	89.5	86.5	88.5
7.5	89.5	88.5	91.7	91.0	91.0	90.2	86.5	89.5
10	90.2	89.5	91.7	91.7	91.0	91.7	89.5	90.2
15	91.0	90.2	92.4	93.0	91.7	91.7	89.5	90.2
20	91.0	91.0	93.0	93.0	91.7	92.4	90.2	91.0

Peak Factors

Table 2-68 Peak Factors

Peak Factor	Value	Ref
Electric coincidence factor (CF)	0.69	[99]
Natural gas peak day factor (PDF)	See Appendix G: Natural Gas Peak Day Factors	

Measure Life

The remaining useful life (RUL) for existing equipment is limited to 1/3 of the effective useful life (EUL) of the equipment.

Table 2-69 Measure Life

Equipment	EUL	RUL	Ref
Water source Pump	15	5	[141]
Ground source heat pump	25	8.33	[89]

References

[86] VEIC Estimate. Consistent with analysis of PEPCo and LIPA, and conservative relative to ARI.

[87] VEIC estimate. Extrapolation of manufacturer data.

[88] *Determining Electric Motor Load and Efficiency*. (DOE, 2014), pg 1,
<https://www.energy.gov/sites/prod/files/2014/04/f15/10097517.pdf>

- [89] ASHRAE: Owning and Operating Cost Database, Equipment Life/Maintenance Cost Survey:
https://xp20.ashrae.org/publicdatabase/system_service_life.asp?selected_system_type=1
- [90] California Public Utilities Commission Database for Energy Efficient Resources (DEER) EUL Support Table for 2020,
<http://www.deeresources.com/files/DEER2020/download/SupportTable-EUL2020.xlsx>
- [91] ASHRAE Standard 90.1-2019, Energy Standard for Buildings Except Low-Rise Residential Buildings. (ASHRAE, 2019), Table 6.8.1-5, <https://www.ashrae.org/technical-resources/standards-and-guidelines/read-only-versions-of-ashrae-standards>
- [92] ASHRAE Standard 90.1-2013, Energy Standard for Buildings Except Low-Rise Residential Buildings. (ASHRAE, 2019), Table 6.8.1-5, <https://www.ashrae.org/technical-resources/standards-and-guidelines/read-only-versions-of-ashrae-standards>
- [93] § *CFR431.25 Energy conservation standards and effective dates*, (2023) Table 1,
<https://www.ecfr.gov/current/title-10/chapter-II/subchapter-D/part-431/subpart-B/subject-group-ECFR03b7039d87b7cc6/section-431.25>
- [94] ASHRAE: Owning and Operating Cost Database, Equipment Life/Maintenance Cost Survey:
https://xp20.ashrae.org/publicdatabase/system_service_life.asp?selected_system_type=1
- [95] “2021 INTERNATIONAL ENERGY CONSERVATION CODE (IECC) | ICC DIGITAL CODES.” n.d. Codes.iccsafe.org. Accessed November 16, 2022. <https://codes.iccsafe.org/content/IECC2021P2/chapter-4-ce-commercial-energy-efficiency>.
- [96] “2012 INTERNATIONAL ENERGY CONSERVATION CODE (IECC) | ICC DIGITAL CODES.” n.d. Codes.iccsafe.org. Accessed January 23, 2023 <https://codes.iccsafe.org/content/IECC2012P5/chapter-4-ce-commercial-energy-efficiency>
- [97] NJ utility analysis of heating customers, annual gas usage
- [98] McQuay Application Guide 31-008, Geothermal Heat Pump Design Manual, 2002. Engineering Estimate - See System Performance of Ground Source Heat Pumps
- [99] NEEP, *Mid-Atlantic Technical Reference Manual*, V9. (October 2019). Pg 95
- [100] ENERGY STAR® HVAC QUALITY INSTALLATION PROGRAM A new approach to residential HVAC efficiency and performance. Pg 2,
https://www.energystar.gov/ia/home_improvement/downloads/ESQI_factsheet.pdf?07d7-31fc

2.3.3 FURNACE AND BOILER

Market	Residential/Multifamily
Baseline Condition	TOS/NC/EREP
Baseline	Code/Existing
End Use Subcategory	HVAC Equipment
Measure Last Reviewed	December 2022

Description

This section provides energy savings algorithms for qualifying furnaces and boilers installed in single family detached and lowrise multifamily buildings. The input values are based on the specifications of the actual equipment being installed and IECC 2021 standards which require an efficiency rating equal to or greater than the minimum required by federal law for single family units and an efficiency rating efficiency rating equal to or greater than the minimum required by ASHRAE 90.1 2019 for systems serving multi family units.

In the case of new construction, replacement of failed equipment, or end of useful life, the baseline furnace or boiler is a minimally code compliant unit with an efficiency as required by IECC 2021, which is the current residential code adopted by the state of New Jersey.

In the case of early replacement of a working unit where the unit would have otherwise continued to function, the dual baseline approach must be followed. Otherwise the savings can be calculated as a time of sale (TOS) measure.

Baseline Case

New construction, time of sale:

- Single Family and Low-Rise Multifamily – Equipment compliant with the IECC 2021 [101].

Early Replacement:

- Existing equipment - Efficiency of the existing equipment for the assumed over remaining useful life of the existing unit, and the normal replacement (NR) baseline for the remainder of the new, efficient equipment measure life. If existing equipment efficiency is unknown, use the code in force when equipment was new.

Efficient Case

Furnace or boiler with an efficiency higher than code or standard practice.

Annual Energy Savings Algorithm

Annual Electric Energy Savings

$$\Delta kWh = N/A$$

Annual Fuel Savings

$$\Delta Therms = Cap_{in} \times EFLH_h \times \frac{Eff_q/Eff_b - 1}{100}$$

Peak Demand Savings

$$\Delta kW_{Peak} = N/A$$

Daily Peak Fuel Savings

$$\Delta Therms_{Peak} = \Delta Therms \times PDF$$

Lifetime Energy Savings Algorithms

Lifetime Electric Energy Savings

$$\Delta kWh_{Life} = \Delta kWh \times EUL$$

Lifetime Fuel Savings

$$\Delta Therms_{Life} = \Delta Therms \times EUL$$

Dual:

Lifetime Electric Energy Savings

$$\Delta kWh_{Life} = \Delta kWh_{EREP} \times RUL + \Delta kWh_{NR} \times EUL$$

Lifetime Fuel Savings

$$\Delta Therms_{Life} = \Delta Therms_{EREP} \times RUL + \Delta Therms_{NR} \times EUL$$

Calculation Parameters

Table 2-70 Calculation Parameters

Variable	Description	Value	Units	Ref
$\Delta Therms$	Annual fuel savings	Calculated	Therms/yr	
$\Delta Therms_{Peak}$	Daily peak fuel savings	Calculated	Therms/day	
$\Delta Therms_{Life}$	Lifetime fuel savings	Calculated	Therms	
Cap_{in}	Input capacity of qualifying unit	Site-specific	kBtu/hr	
Eff_q	Furnace or Boiler Proposed Efficiency	Site-specific	N/A	

Variable	Description	Value	Units	Ref
Eff _b	Furnace or Boiler Baseline Efficiency	Site-specific or unknown lookup in Table 2-71 – single family detached/multifamily low-rise Table 2-73 – Multifamily Units	N/A	[101]
EFLH _h	Equivalent Full Load Hours of operation for the average unit during the heating season	Lookup in Appendix C:	Hrs/yr	
100	Conversion factor	100	kBtu/Therms	
EUL	Estimated useful life	See Measure Life section	years	[102]
RUL	Remaining useful life	See Measure Life section	years	[102]
PDF	Gas peak day factor	Lookup in Table 2-74	N/A	

Table 2-71 Baseline AFUE of Single Family and Low-Rise Multifamily Furnaces

Product Class	AFUE	Compliance Date	AFUE (Manufactured before compliance Date)
Weatherized gas furnaces	81	January 1, 2015.	78
Non-weatherized gas furnaces (not including mobile home furnaces)	80	November 19, 2015.	78
Weatherized oil-fired furnaces	78	January 1, 1992.	78
Non-weatherized oil-fired furnaces (not including mobile home furnaces)	83	May 1, 2013.	78
Mobile Home gas furnaces	80	November 19, 2015.	75
Mobile Home oil-fired furnaces	75	September 1, 1990.	75

* Electric resistance heating calculated by determining overall fuel cycle efficiency by dividing the average PJM heat rate (9,642 btu/kWh) by the btu's per kWh (3,413 btu/kWh), resulting in 2.38 btu_{in} per 1 btu_{out}.

Table 2-72 Baseline AFUE of Single Family and Low-Rise Multifamily Boilers

Product Class	AFUE Manufactured before Sep 1, 2012	AFUE (Manufactured on and after Sep 1, 2012 and before Jan 15, 2021)	AFUE (Manufactured on and after January 15, 2021)
Gas-fired hot water boiler	0.80	0.82	0.84
Gas-fired steam boiler	0.75	0.80	0.82
Oil-fired hot water boiler	0.80	0.84	0.86
Oil-fired steam boiler	0.80	0.82	0.85

Table 2-73 Baseline Efficiencies for Multifamily Units

Product Class	Minimum Efficiency for Units Before 1/1/2023	Minimum Efficiency for Units After 1/1/2023
Warm-air furnace, gas fired	80% E _t	81% E _t
Warm-air furnace, oil fired	80% E _t	82% E _t
Warm-air duct furnaces, gas fired	80% E _c	80% E _c

Peak Factors

Table 2-74 Peak Factors

Peak Factor	Value	Ref
Natural gas peak day factor (PDF)	Appendix G: Natural Gas Peak Day Factors	

Measure Life

The remaining useful life (RUL) for retrofit projects is limited to 1/3 of the effective useful life (EUL) of the equipment.

Table 2-75 Measure Life

Equipment	New construction EUL	Retrofit RUL	Ref
Furnace	20	6.7	[102]
Boiler	20	6.7	[5]

References

- [101] Code of Federal Regulations. 2022. Review of Title 10, Chapter II, Subchapter D, Part 430, Subpart C §430.32(e). December 1, 2022. [https://www.ecfr.gov/current/title-10/chapter-II/subchapter-D/part-430/subpart-C/section-430.32#p-430.32\(e\)](https://www.ecfr.gov/current/title-10/chapter-II/subchapter-D/part-430/subpart-C/section-430.32#p-430.32(e))
- [102] Simulations of prototype buildings from NY TRM updated with NJ weather done by NJ Statewide Evaluator, May 2022
- [103] U.S. DOE. “Technical Support Document: Energy Efficiency Program for Consumer Products and Commercial and Industrial Equipment: Residential Furnaces” and “Technical Support Document: Energy Efficiency Program for Consumer Products and Commercial and Industrial Equipment: Commercial Warm Air Furnaces.” August 30, 2016. Available from: <https://www.regulations.gov/document?D=EERE-2014-BT-STD-0031-0217>

2.3.4 HIGH EFFICIENCY BATHROOM EXHAUST FAN

Market	Residential/Multifamily/Low-Income
Baseline Condition	TOS/DI/EREP
Baseline	Existing
End Use	Ventilation Fan
Measure Last Reviewed	December 2022

Description

This market opportunity is defined by the need for continuous mechanical ventilation due to reduced air-infiltration from a tighter building shell. In retrofit projects, existing fans may be too loud, or insufficient in other ways, to be operated as required for proper ventilation. This measure assumes a fan capacity of 20 CFM at 0.1 inches of water column (w.c.) static pressure and a decibel level below 2 sones. Installations should be sized to meet the minimum ventilation rate as required by ASHRAE 62.2.

Baseline Case

Standard efficiency quiet bathroom ventilation fan, operating at a ventilation rate compliant with ASHRAE 62.2, with an average efficiency of 3.1 CFM/watt

Efficient Case

Energy efficient quiet bathroom ventilation fan, operating at a ventilation rate compliant with ASHRAE 62.2, with an average efficiency of 8.3 CFM/watt

Annual Energy Savings Algorithm

Annual Electric Energy Savings

$$\Delta kWh = CFM \times \left(\frac{1}{Eff_b} - \frac{1}{Eff_q} \right) / 1,000 \times Hrs$$

Annual Fuel Savings

$$\Delta Therms = N/A$$

Peak Demand Savings

$$\Delta kW_{peak} = CFM \times \left(\frac{1}{Eff_b} - \frac{1}{Eff_q} \right) / 1,000 \times CF$$

Daily Peak Fuel Savings

$$\Delta Therms_{peak} = N/A$$

Lifetime Energy Savings Algorithms:

Lifetime Electric Energy Savings

$$\Delta kWh_{Life} = \Delta kWh \times EUL$$

Lifetime Fuel Savings

$$\Delta Therms_{Life} = N/A$$

Calculation Parameters

Table 2-76 Calculation Parameters

Variable	Description	Value	Units	Ref
ΔkWh	Annual electric energy savings	Calculated	kWh/yr	
ΔkW_{Peak}	Peak Demand Savings	Calculated	kW	
ΔkWh_{Life}	Lifetime electric energy savings	Calculated	kWh	
$\Delta Therms_{Life}$	Lifetime fuel savings	Calculated	Therms	
CFM	Nominal Capacity of the exhaust fan	Site-specific, if unknown use 20 CFM	CFM	[104]
Eff_b	Average efficacy for baseline fan	Site-specific, if unknown use 3.1 CFM/watt	CFM/watt	[105]
Eff_q	Average efficacy for efficient fan	Site-specific, if unknown use 8.3 CFM/watt	CFM/watt	[106]
Hrs	Annual hours of operation	8,760	Hrs/yr	
CF	Electric coincidence factor	Lookup in Table 3-132	N/A	
EUL	Effective useful life	See Measure Life section	Years	

Peak Factors

Table 2-77 Peak Factors

Peak Factor	Value	Ref
Electric coincidence factor (CF)	1	

Measure Life

The effective useful life (EUL) is 19 years [107].

References

- [104] 20 CFM is used with continuous bathroom ventilation in ASHRAE 62.2. Note that 50CFM is the closest available fan size to ASHRAE 62.2 Section 4.1 Whole House Ventilation rates based upon typical square footage and bedrooms
- [105] VEIC analysis looking at average baseline fan (i.e. non-Brushless Permanent Magnet) efficacies at static pressures of 0.1 and 0.25 inches of water column for quiet fans rated for 50 CFM
- [106] VEIC analysis looking at average efficient fan (i.e. Brushless Permanent Magnet) efficacies at static pressures of 0.1 and 0.25 inches of water column for quiet fans rated for 50 CFM
- [107] GDS Associates, *Measure Life Report: Residential and C&I Lighting and HVAC measures* (SPWG 2007), https://library.cee1.org/sites/default/files/library/8842/CEE_Eval_MeasureLifeStudyLights&HVACGDS_1Jun2007.pdf

2.3.5 EC MOTOR

Market	Residential/Multifamily
Baseline Condition	RF
Baseline	Existing
End Use Subcategory	Motor
Measure Last Reviewed	December 2022

Description

This measure covers the retrofit installation of an Electronically Commuted (EC) Motor to replace an HVAC supply fan motor or hydronic circulator pump motor in residential heating and cooling systems.

The deemed annual electric energy savings for fans are determined for each New Jersey location by scaling the energy savings derived from the evaluation of a 2014 Wisconsin ECM metering study using heating degree days and cooling degree days for each location.

Electric energy savings for pumps are calculated by multiplying the difference in the reciprocal of motor efficiencies with the efficient circulator motor horsepower.

Baseline Case

An existing HVAC fan or pump with a single-speed, shaded-pole (SP) or permanent-split capacitor (PSC) motor.

Efficient Case

HVAC fan or pump with an Electronically Commuted (EC) Motor.

Annual Energy Savings Algorithm

Annual Electric Energy Savings

Pumps:

$$\Delta kWh = \Delta kWh_h + \Delta kWh_c$$

Where,

$$\Delta kWh_h = hp \times \left(\frac{1}{Eff_b} - \frac{1}{Eff_q} \right) \times LF \times 0.746 \times hrs_h$$

$$\Delta kWh_c = hp \times \left(\frac{1}{Eff_b} - \frac{1}{Eff_q} \right) \times LF \times 0.746 \times hrs_c$$

Fans:

$$\Delta kWh = \Delta kWh_{fan}$$

Annual Fuel Savings

$$\Delta Therms = N/A$$

Peak Demand Savings

Pumps:

$$\Delta kW_{peak} = \frac{\Delta kWh}{hrs} \times CF_{pump}$$

Fans:

$$\Delta kW_{peak} = \Delta kW_{fan} \times CF_{fan}$$

Daily Peak Fuel Savings

$$\Delta Therms_{peak} = N/A$$

Lifetime Energy Savings Algorithms:

Lifetime Electric Energy Savings

$$\Delta kWh_{life} = \Delta kWh \times EUL$$

Lifetime Fuel Savings

$$\Delta Therms_{life} = \Delta Therms \times EUL = N/A$$

Calculation Parameters

Table 2-78 Calculation Parameters

Variable	Description	Value	Units	Ref
ΔkWh	Annual electric energy savings	Calculated	kWh/yr	
$\Delta Therms$	Annual fuel savings	Calculated	Therms/yr	
ΔkW_{Peak}	Annual peak electric demand savings	Calculated	kW	
$\Delta Therms_{Peak}$	Daily peak fuel savings	Calculated	Therms/day	
ΔkWh_{fan}	Annual energy savings per fan motor	Look up in Table 2-80	kWh/unit	[108]
ΔkW_{fan}	Electric demand savings per fan motor	Central A/C: 0.117 No Central A/C: 0 Unknown: 0.05 ¹⁹	kW/unit	[109]
hp	Efficient circulator motor horsepower	Site-specific	HP	
Eff_b	Baseline motor efficiency	Site-specific, if unknown look up in Table 2-79	N/A	[111]
Eff_q	Efficient motor efficiency	Site-specific, if unknown look up in Table 2-79	N/A	[111]
LF	Motor load Factor	0.9	N/A	[110]
hrs _h	Operating hours during the heating season	3,504	hrs/yr	[112]
hrs _c	Operating hours during the cooling season ²⁰	2,208	hrs/yr	
hrs	Total operating hours	5,712	hrs/yr	
0.746	Conversion factor for HP to kWh	0.746	kW/HP	
CF_{fan}	Electric coincidence factor fan	Look up in Table 2-81	N/A	
CF_{pump}	Electric coincidence factor pump	Look up in Table 2-81	N/A	
EUL	Effective Useful Life	See Measure Life Section	Years	
RUL	Remaining Useful Life	See Measure Life Section	Years	

Table 2-79 Default Motor Efficiency by Motor Type

Motor Type	Assumed Efficiency
Shaded Pole (SP)	0.40
Permanent Split Capacitor (PSC)	0.50
ECM	0.70

¹⁹ Weighted average calculated using RECS 2020 Data -<https://www.eia.gov/consumption/residential/data/2020/hc/pdf/HC%207.7.pdf>

²⁰ Cooling assumes three months (92 days) of 24 hour operation

Table 2-80 Annual Fan Energy Savings

Climate Region	Annual Energy Saved (ΔkWh_{fan})					HDD	CDD
	Total with Central AC	Total without Central AC	Circulation Mode	Heating Mode	Cooling Mode		
North	408	315	211	104	93	5,734	778
Coastal	422	295	211	84	127	4,614	1056
Central	432	303	211	92	129	5,052	1073
Pine barrens	428	300	211	89	128	4,891	1067
Southwest	428	303	211	92	125	5,029	1047

*The percent difference in HDD is applied to the Heating Mode column kWh savings and the percent difference in the CDD is applied to the Cooling Mode column kWh savings.

Peak Factors

Table 2-81 Peak Factors

Peak Factor	Value	Ref
Fan coincidence factor (CF_{fan})	0.68	[109]
Pump coincidence factor (CF_{pump})	0.8	[113]
Natural gas peak day factor (PDF)	N/A	

Measure Life

The remaining useful life (RUL) for retrofit projects is limited to the RUL of the host equipment. If unknown, assume 1/3 of the host equipment EUL.

References

- [108] ONJSC: Monthly/Annual Temperature Normals (1991-2020).
http://climate.rutgers.edu/stateclim_v1/norms/monthly/index.html
- [109] Cadmus Group. *Focus on Energy Evaluated Deemed Savings Changes*. November 2014.
- [110] US DOE, *Evaluation of Retrofit Variable-Speed Furnace Fan Motors*, January 2014.
<https://www.nrel.gov/docs/fy14osti/60760.pdf>
- [111] DOE Building Technologies Office. *Energy Savings Potential and Opportunities for High-Efficiency Electric Motors in Residential and Commercial Equipment*.
<https://www.energy.gov/sites/prod/files/2014/02/f8/Motor%20Energy%20Savings%20Potential%20Report%20013-12-4.pdf>. Accessed December 2022
- [112] M Samotyj, *Assessment of New Energy Efficient Circulator Pump Technology*. (EPRI, 2010), Pg 4-3,
<https://www.epri.com/research/products/1020132>
- [113] *New York Standard Approach for Estimating Energy Savings from Energy Efficiency Programs V9*. (New York State Joint Utilities, 2021), Pg 211,
<https://www3.dps.ny.gov/W/PSCWeb.nsf/All/72C23DECF52920A85257F1100671BDD>

2.3.6 DUCT SEALING AND DUCT INSULATION

Market	Residential/Multifamily
Baseline Condition	RF/DI
Baseline	Existing/Dual
End Use Category	HVAC
Measure Last Reviewed	January 2023

Description

This measure describes evaluating the savings associated with performing duct sealing using mastic sealant or metal tape to the distribution system of homes with either central air conditioning or a ducted heating system. The measure also applies to insulating ductwork in unconditioned and semi-conditioned spaces of residential buildings.

If duct insulation is involved with the improvement, the first method, “Evaluation of Distribution Efficiency,” must be used to estimate energy savings.

1) Evaluation of Distribution Efficiency – this methodology requires the evaluation of three duct characteristics below, and use of the Building Performance Institute’s (BPI) “Guidance on Estimating Distribution Efficiency” [114], which are summarized in

Table 2-83 and Table 2-84 for convenience.

- Duct location, including percentage of duct work found within the conditioned space
- Duct leakage evaluation. The duct leakage assessment values are based on an assumption of 6.5% of assumed air handler flow (tight); 21% (average); or 35% (leaky).
- Duct insulation evaluation

Determine Distribution Efficiency by evaluating duct system before and after duct sealing using Building Performance Institute “Guidance on Estimating Distribution Efficiency” or the values reproduced from that document in Table 2-84 that match the duct system, and if the majority of the duct system is in conditioned space add the matching value from Table 2-85, not to exceed 100%.

2) RESNET Test 380 4.4.2 – this method involves the pressurization of the house to 25 Pascals with reference to outside and a simultaneous pressurization of the duct system to reach equilibrium with the envelope or inside pressure of zero Pascals. A blower door is used to pressurize the building to 25 Pascals with reference to outside, when that is achieved the duct blaster is used to equalize the pressure difference between the duct system and the house. The amount of air required to bring the duct system to zero Pascals with reference to the building is the amount of air leaking through the ductwork to the outside. This technique is described in detail in section 4.4.2 of the ANSI/RESNET/ICC 380 - 2016 Standards: <http://www.resnet.us/professional/standards>

Baseline Case

The existing baseline condition is leaky duct work within the unconditioned space in the home.

Efficient Case

The efficient condition is sealed duct work throughout the unconditioned space in the home.

Annual Energy Savings Algorithms

Annual Electric Energy Savings

Methodology 1: Evaluation of distribution efficiency

$$\Delta kWh = \Delta kWh_{cooling} + \Delta kWh_{heating}$$

Where,

$$\Delta kWh_{cooling} = \frac{DE_{post,cool} - DE_{pre,cool}}{DE_{post,cool}} \times EFLH_{cool} \times \frac{Cap_{cool}}{SEER}$$
$$\Delta kWh_{heating} = \frac{DE_{post,heat} - DE_{pre,heat}}{DE_{post,heat}} \times EFLH_{heat} \times \frac{Cap_{heat}}{HSPF}$$

Methodology 2: RESNET Test 803.7

$$\Delta kWh = \Delta kWh_{cooling} + \Delta kWh_{heating}$$

Where,

$$\Delta kWh_{cooling} = \frac{CFM_{25B} - CFM_{25Q}}{400} \times EFLH_{cool} \times \frac{12}{SEER}$$
$$\Delta kWh_{heating} = \frac{CFM_{25B} - CFM_{25Q}}{400} \times EFLH_{heat} \times \frac{12}{HSPF}$$

Annual Fuel Savings

$$\Delta Therms = \frac{\frac{DE_{post,heat} - DE_{pre,heat}}{DE_{post,heat}} \times EFLH_{heat} \times Cap_{heat}}{AFUE \times 100}$$

Peak Demand Savings

$$\Delta kW_{peak} = \frac{\Delta kWh_{cooling}}{EFLH_{cool}} \times CF$$

Daily Peak Fuel Savings

$$\Delta Therms_{peak} = \Delta Therms \times PDF$$

Lifetime Energy Savings Algorithms

Lifetime Electric Energy Savings

$$\Delta kWh_{Life} = \Delta kWh \times EUL$$

Lifetime Fuel Savings

$$\Delta Therms_{Life} = \Delta Therms \times EUL$$

Dual:

Lifetime Electric Energy Savings

$$\Delta kWh_{Life} = \Delta kWh_{EREP} \times RUL + \Delta kWh_{NR} \times EUL$$

Lifetime Fuel Savings

$$\Delta Therms_{Life} = \Delta Therms_{EREP} \times RUL + \Delta Therms_{NR} \times EUL$$

Calculation Parameters

Table 2-82 Calculation Parameters

Variable	Description	Value	Units	Ref
ΔkWh	Annual electric energy savings	Calculated	kWh/yr	
$\Delta kWh_{cooling}$	Annual electric energy savings, cooling	Calculated	kWh/yr	
$\Delta kWh_{heating}$	Annual electric energy savings, heating	Calculated	kWh/yr	
$\Delta Therms$	Annual fuel savings	Calculated	Therms/yr	
ΔkW_{Peak}	Peak Demand Savings	Calculated	kW	
$\Delta Therms_{Peak}$	Daily peak fuel savings	Calculated	Therms/day	
ΔkWh_{Life}	Lifetime electric energy savings	Calculated	kWh	
$\Delta Therms_{Life}$	Lifetime fuel savings	Calculated	Therms	
Cap_{cool}	Capacity of air cooling system	Site-specific	kBtu/hr	
Cap_{heat}	Capacity of air heating system	Site-specific	kBtu/hr	
CFM_{25B}	Standard duct leakage test result at 25 Pascal pressure differential of the duct system prior to sealing	Site-specific	CFM	
CFM_{25Q}	Standard duct leakage test result at 25 Pascal pressure differential of the duct system after sealing	Site-specific	CFM	
SEER	Seasonal energy efficiency ratio	Site-specific, if unknown look up in Table 2-85	Btu/W·hr	[114]
HSPF	Heating seasonal performance factor	Site-specific, if unknown look up in Table 2-85	Btu/W·hr	[114]
DE_{post}	Distribution efficiency after duct sealing and insulation	Look up in Table 2-83. For conditioned area, look up adder in Table 2-84	N/A	[115]
DE_{pre}	Distribution efficiency before duct sealing and insulation	Look up in Table 2-83. For conditioned area, look up adder in Table 2-84	N/A	[115]

Variable	Description	Value	Units	Ref
AFUE	Annual fuel utilization efficiency	Look up in Table 2-86	N/A	[114]
EFLH _{cool}	Cooling equivalent full load hours	600	Hrs	
EFLH _{heat}	Heating equivalent full load hours	965	Hrs	
400	Rule of Thumb, CFM/ton	Site-specific, if unknown use 400	CFM/ton	
12	Unit conversion, kBtu/hr-ton	12	kBtu/ hr-ton	
100	Unit conversion, kBtu/therm	100	kBtu/therm	
CF	Electric coincidence factor	Look up in Table 2-87	N/A	
PDF	Gas peak day factor	Look up in Table 2-87	N/A	
EUL	Effective useful life	See Measure Life Section	Years	

Table 2-83 Distribution Efficiencies

Duct Insulation	Location	Attic		Basement		Vented Crawl	
	Leakage Assessment / HVAC Type	Heat	Cool	Heat	Cool	Heat	Cool
R-0	Leaky	0.69	0.61	0.93	0.81	0.74	0.76
	Average	0.73	0.64	0.94	0.87	0.78	0.83
	Tight	0.77	0.73	0.95	0.94	0.82	0.91
R-2	Leaky	0.76	0.65	0.94	0.83	0.80	0.78
	Average	0.82	0.74	0.96	0.88	0.85	0.85
	Tight	0.87	0.84	0.97	0.95	0.90	0.93
R-4+	Leaky	0.79	0.67	0.95	0.83	0.82	0.79
	Average	0.84	0.77	0.96	0.89	0.87	0.86
	Tight	0.90	0.87	0.98	0.95	0.92	0.94
R-8+	Leaky	0.80	0.69	0.95	0.83	0.84	0.79
	Average	0.86	0.79	0.97	0.89	0.89	0.87
	Tight	0.92	0.90	0.98	0.95	0.94	0.94

For duct systems partly in unconditioned and conditioned space, add the values from Table 2-84 below to DE_{pre} and DE_{post} determined from

Table 2-83, with a max DE of 100%. Use the 50% adder values if 50% or more of the duct system is inside a conditioned space. Use the 80% adder values if 80% of more of the duct system is inside a conditioned space.

Table 2-84 Distribution Efficiencies Adders for Conditioned Space

Location	Attic				Basement				Vented Crawl			
HVAC Type	Heat		Cool		Heat		Cool		Heat		Cool	
Insulation/ Conditioned	50%	80%	50%	80%	50%	80%	50%	80%	50%	80%	50%	80%

Location	Attic				Basement				Vented Crawl			
R-0	0.06	0.11	0.04	0.09	0.02	0.03	0.02	0.03	0.06	0.11	0.03	0.05
R-2	0.04	0.06	0.04	0.07	0.01	0.01	0.01	0.02	0.03	0.05	0.02	0.03
R-4+	0.03	0.04	0.03	0.05	0.01	0.01	0.01	0.01	0.02	0.04	0.01	0.03
R-8+	0.02	0.03	0.02	0.03	0.01	0.01	0.01	0.01	0.02	0.02	0.01	0.02

Table 2-85 SEER and HSPF Values

Product Class	SEER	HSPF
Split systems – air conditioners	13	-
Split systems – heat pumps	14	8.2
Single package units – air conditioners	14	-
Single package units – heat pumps	14	8.0

Table 2-86 AFUE Values

Product Class	AFUE
Gas-fired hot water boiler	0.82
Gas-fired steam boiler	0.80
Oil-fired hot water boiler	0.84
Oil-fired steam boiler	0.82
Non-weatherized gas furnaces	0.80
Mobile home gas furnaces	0.80
Non-weatherized oil-fired furnaces	0.83
Mobile home oil-fired furnaces	0.75
Weatherized gas furnaces	0.81
Weatherized oil-fired furnaces	0.78
Electric furnaces	0.78

Peak Factors

Table 2-87 Peak Factors

Peak Factor	Value	Ref
Electric coincidence factor (CF)	0.69	[116]
Natural gas peak day factor (PDF)	See Appendix G: Natural Gas Peak Day Factors	

Measure Life

The remaining useful life (RUL) for existing equipment is limited to 1/3 of the effective useful life (EUL) of the equipment.

Table 2-88 Measure Life

Equipment	EUL	RUL	Ref
Duct Sealing & Duct Insulation	15	5	[118]

References

- [114] 10 CFR Subpart C of Part 430, <https://www.ecfr.gov/current/title-10/chapter-II/subchapter-D/part-430/subpart-C/section-430.32>
- [115] Building Performance Institute, Duct Efficiency Tables, <http://www.bpi.org/files/pdf/DistributionEfficiencyTable-BlueSheet.pdf>
- [116] BG&E, Development of Residential Load Profile for Central Air Conditioners and Heat Pumps.
- [117] Residential Energy Services Network, ANSI/RESNET/ICC 380-2019. http://www.resnet.us/blog/wp-content/uploads/2016/01/ANSI-RESNET-ICC_380-2016-posted-on-website-6-15-16.pdf
- [118] California Public Utilities Commission Database for Energy Efficient Resources (DEER) EUL Support Table for 2020, <http://www.deeresources.com/files/DEER2020/download/SupportTable-EUL2020.xlsx>

2.3.7 HEAT OR ENERGY RECOVERY VENTILATOR

Market	Residential
Baseline Condition	NC/TOS
Baseline	Code
End Use Subcategory	Heat Recovery
Measure Last Reviewed	December 2022

Description

This measure covers the installation of Energy Recovery Ventilators (ERV) and Heat Recovery Ventilators (HRV). ERVs and HRVs reduce heating and cooling loads while maintaining required ventilation rates by facilitating heat transfer between outgoing conditioned air and incoming outdoor air. ERVs and HRVs employ air-to-air heat exchangers to recover energy from exhaust air for the purpose of pre-conditioning outdoor air prior to supplying the conditioned air to the space, either directly or as part of an air-conditioning system. This measure only applies in cases where ERV/HRV functionality is not required by federal, state, local, or municipal codes or standards. For the purposes of this measure, ERVs and HRVs are distinguished as follows:

- Energy Recovery Ventilator (ERV): Transfers both sensible (heat content) and latent (moisture content) heat between supply and exhaust airstreams.
- Heat Recovery Ventilator (HRV): Transfers sensible heat only between supply and exhaust airstreams.

Baseline Case

The baseline condition for this measure is a single- or multifamily dwelling with an IECC 2021-compliant exhaust fan system with no heat or energy recovery.

Efficient Case

The compliance condition for this measure is a single- or multifamily dwelling with an ASHRAE 62.2-compliant exhaust fan system equipped with AHRI certified ERV or HRV components.

Annual Energy Savings Algorithm

Annual Electric Energy Savings

$$\Delta kWh = \Delta kWh_c + \Delta kWh_h + \Delta kWh_{fan}$$

Cooling energy savings:

For ERVs:

$$\Delta kWh_c = \frac{4.5 \times CFM \times Eff_{hx,total} \times (H_{outdoor,c} - H_{indoor})}{1,000 \times SEER} \times hrs_c$$

For HRVs:

$$\Delta kWh_c = \frac{1.08 \times CFM \times Eff_{hx,sens} \times (T_{outdoor,c} - T_{indoor})}{1,000 \times SEER} \times \frac{hrs_c}{1}$$

Heating energy savings (both ERVs and HRVs):

$$\Delta kWh_h = \frac{1.08 \times CFM \times Eff_{hx,sens} \times (T_{indoor} - T_{outdoor,h})}{1,000 \times HSPF} \times F_{ElecHeat} \times \frac{hrs_h}{1}$$

Fan energy savings:

$$\Delta kWh_{fan} = \Delta kW_{fan} \times (hrs_h + hrs_c)$$

$$\Delta kW_{fan} = CFM \times 1,000 \times \left(\frac{1}{(cfm/watt)_b} - \frac{1}{(cfm/watt)_q} \right)$$

Annual Fuel Savings

$$\Delta Therms = \frac{1.08 \times CFM \times Eff_{hx,sens} \times (T_{indoor,h} - T_{outdoor,h})}{100,000 \times AFUE} \times F_{FuelHeat} \times \frac{hrs_h}{60}$$

Summer Peak Demand Savings

$$\Delta kW_{Peak} = \left(\frac{1.08 \times CFM \times Eff_{hx,sense} \times (T_{outdoor,c,peak} - T_{indoor,c})}{1,000 \times EER} + \Delta kW_{fan} \right) \times CF$$

Daily Peak Fuel Savings

$$\Delta Therms_{Peak} = \Delta Therms \times PDF$$

Lifetime Energy Savings Algorithms:

Lifetime Electric Energy Savings

$$\Delta kWh_{Life} = \Delta kWh \times EUL$$

Lifetime Fuel Savings

$$\Delta Therms_{Life} = \Delta Therms \times EUL$$

Calculation Parameters

Table 2-89 Calculation Parameters

Variable	Description	Value	Units	Ref
ΔkWh	Annual electric energy savings	Calculated	kWh/yr	
$\Delta Therms$	Annual fuel savings	Calculated	Therms/yr	
ΔkW_{Peak}	Peak Demand Savings	Calculated	kW	

Variable	Description	Value	Units	Ref
$\Delta\text{Therms}_{\text{Peak}}$	Daily peak fuel savings	Calculated	Therms/day	
$\Delta\text{kWh}_{\text{Life}}$	Lifetime electric energy savings	Calculated	kWh	
$\Delta\text{Therms}_{\text{Life}}$	Lifetime fuel savings	Calculated	Therms	
ΔkWh_c	Annual electric energy savings during cooling season	Calculated	kWh	
ΔkWh_h	Annual electric energy savings during heating season	Calculated	kWh	
$\Delta\text{kWh}_{\text{fan}}$	Annual electric energy savings due to fan operation	Calculated	kWh	
CFM	Flow rate of supply air passing through ERV/HRV	Site-specific	Ft ³ /min	
(cfm/watt) _b	Baseline ERV/HRV fan efficacy	Look up in Table 2-93	cfm/watt	[128]
(cfm/watt) _a	Efficient ERV/HRV fan efficacy	Site-specific	cfm/watt	
$\text{Eff}_{\text{hx,total}}$	Total effectiveness of heat exchanger per rating in accordance with AHRI Standard 1060	Site-specific	N/A	[119]
$\text{Eff}_{\text{hx,sens}}$	Sensible effectiveness of heat exchanger per rating in accordance with AHRI Standard	Site-specific, if unknown use 0.65	N/A	[128]
SEER	Seasonal average energy efficiency of electric cooling equipment (SEER)	Site-specific, if unknown lookup in Appendix E: Code-Compliant Efficiencies for equipment type and size. If SEER2 is available, use SEER2	Btu/watt-hour	[120]
EER	Energy efficiency ratio of electric cooling equipment ²¹	Site-specific, if unknown lookup in Appendix E: Code-Compliant Efficiencies for equipment type and size	Btu/watt-hour	
HSPF	Heating seasonal performance factor of electric heating equipment ²²	Site-specific, if unknown lookup in Appendix E: Code-Compliant Efficiencies for equipment type and size. If HSPF2 is available use HSPF2	Btu/watt-hour	

²¹ For equipment rated in EER2, use EER2. If unknown, calculate EER as follows:

$$EER = (1.12 \times SEER) - (0.02 \times SEER^2)$$

²² If needed, convert COP to HSPF as follows:

$$HSPF = COP \times 3.412. \text{ COP for electric resistance heat is } 1.0$$

Variable	Description	Value	Units	Ref
AFUE	Efficiency of fossil fuel heating equipment (AFUE, Et or Ec)	Site-specific, if unknown lookup in Appendix E: Code-Compliant Efficiencies for equipment type and size	N/A	
T _{indoor,h}	Indoor heating setpoint temperature	Site-specific, if unknown use 70	°F	
T _{indoor,c}	Indoor cooling setpoint temperature	Site-specific, if unknown use 70	°F	
H _{indoor}	Enthalpy of indoor air	Lookup in Table 2-90 based on T _{indoor}	Btu/lb	
HP	Total fan horsepower	Site-specific	HP	
LF	Load factor	Site-specific, if unknown use 0.92	N/A	[127]
hrs _c	Operating hours in the cooling season	Look up in Table 2-90	hrs	[125]
hrs _h	Operating hours in the heating season	Look up in Table 2-90	hrs	[125]
T _{outdoor,c}	Temperature of outside air during cooling	Look up in Table 2-91	Btu/lb	[126]
T _{outdoor,h}	Temperature of outside air during heating	Look up in Table 2-91	Btu/lb	[126]
T _{outdoor,c,peak}	Peak outdoor temperature during cooling season	Look up in Table 2-94	°F	[129]
H _{outdoor,c,peak}	Peak Enthalpy of outdoor air during cooling season	Look up in Table 2-94	°F	[129]
H _{outdoor,c}	Enthalpy of outside air during cooling	Lookup in Table 2-91	Btu/lb	[126]
F _{ElecHeat}	Electric heating factor, to account for presence of electric heat	Use 1 if electric heat, otherwise use 0	N/A	
F _{FuelHeat}	Fuel heating factor, to account for presence of fuel heat	Use 1 if fuel heat, otherwise use 0	N/A	
1.08	Specific heat of air × density of inlet air @ 70°F × 60 min/hr	1.08	BTU/h.°F.CFM	
4.5	Density of inlet air at 70 °F x 60 min/hr	4.5	Lb.min/ft ³ .hr	
60	Minutes per hour	60	Min/hr	
1,000	Conversion factor, one kW equals 1,000 Watts	1,000	W/kW	

Variable	Description	Value	Units	Ref
100,000	Conversion from Btu to therms	100,000	Btu/therm	
0.746	Conversion from horsepower to kW	0.746	kW/hp	
CF	Electric coincidence factor	Look up in Table 2-95	N/A	[123]
PDF	Gas peak day factor	Look up in Table 2-95	N/A	
EUL	Effective useful life	See Measure Life Section	Years	

Table 2-90 Indoor Enthalpy

Temperature, T_{indoor} (°F)	Enthalpy, H_{indoor} at 50% Relative Humidity (Btu/lb)	Temperature, T_{indoor} (°F)	Enthalpy, H_{indoor} at 50% Relative Humidity (Btu/lb)
65	22.7	72	26.4
66	23.2	73	27.0
67	23.7	74	27.5
68	24.2	75	28.1
69	24.8	76	28.7
70	25.3	77	29.3
71	25.8	78	29.9

Table 2-91 Heating and Cooling Hours²³

NJ Climate Region	Heating Hours, hrs_h	Cooling Hours, hrs_c
Northern	4,970	1,670
Southern	4,896	1,783
Coastal	4,981	1,954
Central	4,969	1,810
Pine Barrens	4,899	1,828

²³ Calculated from TMY3 data for representative weather stations for each NJ climate zone. Cooling hours are defined as any hour when outdoor air temperature is above 65°F for the months of June through August and heating hours are defined as any hour when outdoor air temperature is below 65°F for the months of October through April. The heating and cooling hours above represent the count of each in a typical meteorological year.

Table 2-92 Outdoor Air Temperature and Enthalpy

NJ Climate Region	Avg. outdoor temperature during cooling season, $T_{\text{outdoor,c}}$ (°F)	Avg. outdoor temperature during heating season, $T_{\text{outdoor,h}}$ (°F)	Avg. enthalpy ²⁴ of outdoor air at duing cooling season, $H_{\text{outdoor,c}}$ (Btu/lb)
Northern	74.6	42.1	13.1
Southern	74.5	42.7	27.8
Coastal	73.0	46.2	27.0
Central	74.3	43.2	27.7
Pine Barrens	73.7	43.4	27.4

Table 2-93 Baseline Fan Efficacy

Fan Location	Airflow Rate Minimum (CFM)	Minimum Efficacy (CFM/Watt)
HRV,ERV	Any	1.2
In-line supply or exhaust fan	Any	3.8
Other exhaust fan	<90	2.8
Other exhaust fan	>= 90	3.5
Unknown	Any	2.8

Table 2-94 Peak Outdoor Air Temperature and Enthalpy

NJ Climate Region	Peak outdoor temperature during cooling season, $T_{\text{outdoor,c,peak}}$ (°F)	Peak Enthalpy of outdoor air at duing cooling season, $H_{\text{outdoor,c,peak}}$ (Btu/lb)
Northern	89	40.24
Southern	93	42.28
Coastal	90	41.26
Central	93	42.28
Pine Barrens	94	41.22

Peak Factors

Table 2-95 Peak Factors

Peak Factor	Value	Ref
Electric coincidence factor (CF)	0.69	[123]

²⁴ Assuming 50% relative humidity

Peak Factor	Value	Ref
Natural gas peak day factor (PDF)	See Appendix G: Natural Gas Peak Day Factors	

Measure Life

The effective useful life (EUL) is 14 years [124].

References

- [119] Performance Rating of air-to-air exchanges for Energy Recovery Ventilation Equipment, AHRI, December 2022. <http://www.ahrinet.org/ERVcertification>
- [120] 10 CFR 430.32 (c)(1) , December 2022. <https://www.ecfr.gov/current/title-10/chapter-II/subchapter-D/part-430>
- [121] ASHRAE 90.1 2013, Section 6.5.3.1.3, June 2014. <http://arkanarzesh.com/wp-content/uploads/2016/09/ASHRAE%2090.1-2013%20%20IP.pdf>
- [122] 10 CFR 431.446 , December 2022. <https://www.ecfr.gov/current/title-10/chapter-II/subchapter-D/part-431>
- [123] Based on BG&E ‘Development of Residential Load Profile for Central Air Conditioners and Heat Pumps’ research, the Maryland Peak Definition coincidence factor is 0.69. This study is not publicly available, but is referenced by M. M. Straub, Using Available Information for Efficient Evaluation of Demand-Side Management Programs, Electricity Journal, and supported by research conducted by Cadmus on behalf of the RM Management Committee, September 2011.
- [124] PA Consulting Group Inc., Focus on Energy Evaluation Business Programs: Measure Life Study, final report, August 2009
https://focusonenergy.com/sites/default/files/bpmeasurelifestudyfinal_evaluationreport.pdf
- [125] ONJSC: Monthly/Annual Temperature Normals (1991-2020), December 2022
http://climate.rutgers.edu/stateclim_v1/norms/monthly/index.html.
- [126] NSRDB, TMY3 data, December 2022. <https://nsrdb.nrel.gov/data-sets/tmy>
- [127] *Proposed Standard Savings Estimation Protocol for Ultra-Premium Efficiency Motors*, Cascade Energy, November 5, 2012. Table 6: Load Factor by Nameplate hp and End Use. November 5, 2012
- [128] “2021 INTERNATIONAL ENERGY CONSERVATION CODE (IECC) | ICC DIGITAL CODES.” n.d. Codes.iccsafe.org. Accessed November 16, 2022. <https://codes.iccsafe.org/content/IECC2021P2/chapter-4-ce-commercial-energy-efficiency>.
- [129] ASHRAE Fundamentals 2021 - Chapter 14 Climactic Design Conditions - <https://handbook.ashrae.org/Handbook.aspx#>

2.3.8 MAINTENANCE

Market	Residential /Low Income/Multifamily
Baseline Type	RF
Baseline	Existing
End Use Subcategory	Maintenance
Measure Last Reviewed	December 2022

Description

This section provides energy savings algorithms for existing HVAC maintenance in residential applications.

For gas applications, a tune-up of residential fossil fuel space heating boilers or furnaces results in improved seasonal heating efficiency. A tune-up typically involves inspection, cleaning the heating unit of dust and dirt, checking safety components, and/or adjustment of boiler and appurtenances per manufacturer’s recommendations.

A gas savings calculation requires measurement of steady state furnace or boiler efficiency before and after maintenance using an electronic combustion analyzer. Alternatively, before and after maintenance efficiencies may be measured following the method described in ANSI/ASHRAE Standard 103-2007, Method of Testing for Annual Fuel Utilization Efficiency of Residential Central Furnaces and Boilers. Maximum post-maintenance efficiency must not exceed equipment nameplate efficiency. Technicians performing maintenance must provide documentation of before- and after-combustion analysis results.

Electric Units such as Central A/C and heat pumps also benefit greatly from tune ups. A tune up typically includes cleaning filters, inspecting bearings, verification of refrigerant charge and correct, if necessary, clean condenser, and if accessible, evaporator coil.

Note that gas savings calculations (therms) are only applicable for gas units, whereas electric saving calculations are only applicable for electric units.

Baseline Case

Gas: Residential fossil fuel space heating boiler or furnace in a single family or low-rise *Multifamily* building that has not received a tune-up in 5 years or more.

Electric: An existing central A/C, air source heat pump, ground source heat pump, ductless mini-split heat pump, mini-split AC, PTAC, or PTHP unit that has not received a tune-up in 5 years or more.

Efficient Case

Gas: Residential fossil fuel space heating boiler or furnace that has undergone a tune-up in accordance with the manufacturer’s recommendations.

Electric: Electric unit after receiving tune-up.

Annual Energy Savings Algorithm

Annual Electric Energy Savings

$$\Delta kWh = \Delta kWh_c + \Delta kWh_h$$

Where,

$$\Delta kWh_c = \frac{Cap_c}{SEER} \times SF \times EFLH_c$$

$$\Delta kWh_h = \frac{Cap_h}{HSPF} \times SF \times EFLH_h$$

For geothermal heat pumps:

$$SEER = EER_g \times GSHPDF \times GSER$$

$$HSPF = COP_g \times GSHPDF \times 3.412$$

For PTAC and PTHP:

$$SEER = EER$$

Annual Fuel Savings

$$\Delta Therms = Cap_{in} \times ELFH_h \times \frac{\left(\frac{1}{SSE_b} - \frac{1}{SSE_q} \right)}{100}$$

Peak Demand Savings

$$\Delta kW_{peak} = \frac{Cap_c}{EER} \times SF \times CF$$

For geothermal heat pumps:

$$EER = EER_g \times GSPK$$

Daily Peak Fuel Savings

$$\Delta Therms_{Peak} = \Delta Therms \times PDF$$

Lifetime Energy Savings Algorithms:

Lifetime Electric Energy Savings

$$\Delta kWh_{Life} = \Delta kWh \times EUL$$

Lifetime Fuel Savings

$$\Delta Therms_{Life} = \Delta Therms \times EUL$$

Calculation Parameters

Table 2-96 Calculation Parameters

Variable	Description	Value	Units	Ref
ΔkWh	Annual electric energy savings	Calculated	kWh/yr	
$\Delta Therms$	Annual fuel savings	Calculated	Therms/yr	
ΔkW_{Peak}	Peak Demand Savings	Calculated	kW	
$\Delta Therms_{Peak}$	Daily peak fuel savings	Calculated	Therms/day	
ΔkWh_{Life}	Lifetime electric energy savings	Calculated	kWh	
$\Delta Therms_{Life}$	Lifetime fuel savings	Calculated	Therms	
ΔkWh_c	Annual electric cooling energy savings	Calculated	kWh/yr	
ΔkWh_h	Annual electric heating energy savings	Calculated	kWh/yr	
SSE_b	Steady state efficiency of baseline gas HVAC equipment	Site-specific	N/A	
SSE_q	Steady state efficiency of repaired gas HVAC equipment	Site-specific	N/A	
Cap_c	Cooling Capacity of electrical unit receiving tune-up	Site-specific	kBtu/hr	
Cap_h	Heating Capacity of electrical unit receiving tune-up	Site-specific	kBtu/hr	
Cap_{in}	Input capacity of unit receiving tune-up	Site-specific	kBtu/hr	
EER	Energy Efficiency Ratio of unit receiving tune-up	Site-specific. If unknown, see Appendix E: Code-Compliant Efficiencies	Btu/W-h	[133]
EER_g	Full Load Energy Efficiency Ratio of ground source heat pump receiving tune up (this is measured differently than EER of an ASHP and must be converted)	Site-specific	Btu/W-h	
SEER/EER/HSPF/SEER2, EER2, HSPF2	Efficiency of unit receiving tune-up	Site-specific. If unknown, see Appendix E: Code-Compliant Efficiencies	Btu/W-h	[133]

Variable	Description	Value	Units	Ref
COP _g	Full Load coefficient of Performance of ground source heat pump receiving tune-up	Site-specific	N/A	
HSPF	Heating Seasonal Performance Factor of unit receiving tune-up	Site-specific. If unknown, see Appendix E: Code-Compliant Efficiencies	Btu/W-h	[133]
SF	Savings factor, assumed savings due completion of tune up ²⁵	0.05	N/A	[139]
EFLH _h	Equivalent Full Load Hours of operation for the average unit during the heating season	965	Hours	[130]
EFLH _c	Equivalent Full Load Hours of operation for the average unit during the cooling season ²⁶	600	Hours	[132]
GSER	Factor used to determine the SEER of a GSHP based on its EER _g	1.02	Btu/W-h	
GSPK	Factor to convert EER _g to the equivalent EER of an air conditioner to enable comparisons to the baseline unit	0.8416	N/A	
GSHPDF	Ground Source Heat Pump De-rate Factor	0.885	N/A	
3.412	Conversion from Btu to W-h	3.412	Btu/W-h	
CF	Electric coincidence factor	Look up in Table 2-97	N/A	
PDF	Gas peak day factor	Look up in Table 2-97	N/A	
EUL	Estimated useful life	Look up in Table 2-98	Years	
100	Conversion from kBtu to therms	100	kBtu/Therms	

Peak Factors

Table 2-97 Peak Factors

Peak Factor	Value	Ref
Electric coincidence factor (CF)	0.69	[131]
Natural gas peak day factor (PDF)	See Appendix G: Natural Gas Peak Day Factors	

²⁵ VEIC estimate. Extrapolation of manufacturer data.

²⁶ VEIC Estimate. Consistent with analysis of PEPco and LIPA, and conservative relative to ARI.

Measure Life

Measure life is dependent on the gas/electric equipment receiving a tune-up.

Table 2-98 Measure Life

Equipment	EUL	Ref
Air Conditioner – Room (RAC)	12	[134]
Air Conditioner – Central (CAC)	15	[135]
Air Conditioner – PTAC	15	[135]
Boiler, Hot Water – Steel Water Tube	24	[136]
Boiler, Hot Water – Steel Fire Tube	25	[136]
Boiler, Hot Water – Cast Iron	35	[136]
Boiler, Steam – Steel Water Tube	30	[136]
Boiler, Steam – Steel Fire Tube	25	[136]
Boiler, Steam – Cast Iron	30	[136]
Furnace, Gas Fired	22	[137]
Gas Heat Pump	15	[135]
Heat Pump - Air Source (ASHP)	15	[135]
Heat Pump – Ground Source (GSHP)	25	[138]
Heat Pump – PTHP	15	[135]

References

- [130] NJ utility analysis of heating customers, annual gas usage.
- [131] NEEP, *Mid-Atlantic Technical Reference Manual, V10* (May 2020).
- [132] VEIC estimate.
- [133] NMR Group, Inc., *2018 Pennsylvania Statewide Act 129 Residential Baseline Study* (Feb 2018).
https://www.puc.pa.gov/Electric/pdf/Act129/SWE-Phase3_Res_Baseline_Study_Rpt021219.pdf
- [134] GDS Associates, Inc., *Measure Life Report: Residential and Commercial/Industrial Lighting and HVAC Measures* (June 2007) Table 1 – Residential Measures.
- [135] DEER 2014 EUL. http://www.deeresources.com/files/DEER2013codeUpdate/download/DEER2014-EUL-table-update_2014-02-05.xlsx
- [136] ASHRAE Handbook, 2015.
- [137] U.S. DOE. *Technical Support Document: Energy Efficiency Program for Consumer Products and Commercial and Industrial Equipment: Residential Furnaces and Technical Support Document: Energy Efficiency Program for Consumer Products and Commercial and Industrial Equipment: Commercial Warm Air Furnaces* (2016). <https://www.regulations.gov/document?D=EERE-2014-BT-STD-0031-0217>
- [138] ASHRAE: *Owning and Operating Cost Database, Equipment Life/Maintenance Cost Survey*.
https://xp20.ashrae.org/publicdatabase/system_service_life.asp?selected_system_type=1

[139] *Residential HVAC Installation Practices: A Review of Research Findings* (US DOE, 2018), Pg 5.
<https://www.energy.gov/eere/buildings/articles/residential-hvac-installation-practices-review-research-findings>

2.3.9 BOILER CONTROLS

Market	Residential/Multifamily
Baseline Condition	RF
Baseline	Existing
End Use	HVAC
Measure Last Reviewed	December 2022

Description

This measure applies to the installation of reset controls to a residential heating boiler to adjust the boiler water temperature based on the outdoor air temperature. A boiler reset control has two temperature sensors - one outside the house and one in the boiler water. As the outdoor temperature rises and falls, the control adjusts the water temperature to the lowest setting required to meet heating demand.

The input values are based on data supplied by the utilities and customer information on the application form, confirmed with manufacturer data. Unit savings are based on study results.

Baseline Case

Existing boiler without reset controls.

Efficient Case

Installation of boiler reset controls. The system's minimum temperature setpoint must be set no more than 10 degrees above manufacturer's recommended minimum return temperature.

Annual Energy Savings Algorithm

Annual Electric Energy Savings

$$\Delta kWh = N/A$$

Annual Fuel Savings

$$\Delta Therms = SF \times \frac{EFLH_h \times Cap_{in}}{100}$$

Peak Demand Savings

$$\Delta kW_{Peak} = N/A$$

Daily Peak Fuel Savings

$$\Delta Therms_{Peak} = \Delta Therms \times PDF$$

Lifetime Energy Savings Algorithms:

Lifetime Electric Energy Savings

$$\Delta kWh_{Life} = N/A$$

Lifetime Fuel Savings

$$\Delta Therms_{Life} = \Delta Therms \times EUL$$

Calculation Parameters

Table 2-99 Calculation Parameters

Variable	Description	Value	Units	Ref
$\Delta Therms$	Annual fuel savings	Calculated	Therms/yr	
$\Delta Therms_{Peak}$	Daily peak fuel savings	Calculated	Therms/day	
Cap_{in}	Input capacity of boiler	Site specific	kBtu/hr	
SF	Savings factor, estimated percent reduction in heating load due to controls being installed.	0.05	N/A	[463]
$EFLH_h$	Estimated full load hours for heating	Lookup in Table 3-120	hrs	[465]
EUL	Effective useful life	Lookup in Table 2-102	Years	
PDF	Peak day factor	Lookup in Table 2-101		
100	Conversion from kBtu to therm	100	kBtu	

Table 2-100 EFLH During Heating Season

Facility Type	Prior to 1979	From 1979 to 2006	From 2007 through Present
Single Family	965	965	965
Low-rise	757	723	503
High-rise	526	395	219

Peak Factors

Table 2-101 Peak Factors

Peak Factor	Value	Ref
Electric coincidence factor (CF)	N/A	

Peak Factor	Value	Ref
Natural gas peak day factor (PDF)	See Appendix G: Natural Gas Peak Day Factors	

Measure Life

The effective useful life (EUL) of boiler controls is the smaller of to the remaining useful life (RUL) of the boiler or 7.33 years. If boiler RUL is unknown, assume 1/3 of the boiler EUL.

Table 2-102 Measure Life

Equipment	EUL	RUL	Ref
Boiler, Hot Water – Steel Water Tube	24	8	[466]
Boiler, Hot Water – Steel Fire Tube	25	8.33	[466]
Boiler, Hot Water – Cast Iron	35	11.67	[466]
Boiler, Steam – Steel Water Tube	30	10	[466]
Boiler, Steam – Steel Fire Tube	25	8.33	[466]
Boiler, Steam – Cast Iron	30	10	[466]

References

- [140] GDS Associates, Inc. Natural Gas Energy Efficiency Potential in Massachusetts, 2009, p. 38 Table 6-4.
https://ma-eeac.org/wp-content/uploads/5_Natural-Gas-EE-Potential-in-MA.pdf
- [141] Simulations of prototypical buildings from the NY TRM updated with NJ weather done by NJ Statewide Evaluator, May 2022.
- [142] ASHRAE Handbook, 2015.

2.3.10 FILTER WHISTLE

Market	Residential/Low-Income
Baseline Condition	RF/DI
Baseline	Existing/Dual
End Use Subcategory	Filter Whistle
Measure Last Reviewed	December 2022

Description

This section provides energy savings algorithms for filter whistles on air handlers installed in residential settings. Dirty air handler filters result in increases energy consumption for the circulation fan and decreases system heating and cooling efficiency. These whistles attach to the filter of the air handler and make a sound when it is time to replace the filter.

Savings estimates are based on reduced blower fan motor power requirements for winter and summer use of the blower fan motor. This air handler filter whistle measure applies to central forced-air furnaces, central AC and heat pump systems. Where homes do not have central cooling, only the annual heating savings will apply.

Baseline Case

Air Handler Filter without Filter Whistle

Efficient Case

Air Handler Filter with Filter Whistle to promote regular replacement of filter

Annual Energy Savings Algorithm

Annual Electric Energy Savings

$$\Delta kWh = \Delta kWh_{heat} + \Delta kWh_{cool}$$

Where,

$$kW_{motor} = HP \times 0.746$$

$$\Delta kWh_{heat} = kW_{motor} \times EFLH_h \times EI \times ISR$$

$$\Delta kWh_{cool} = kW_{motor} \times EFLH_c \times EI \times ISR$$

Annual Fuel Savings

$$\Delta Therms = N/A$$

Peak Demand Savings

$$\Delta kW_{Peak} = \frac{\Delta kWh_{cool}}{EFLH_c} \times CF$$

Daily Peak Fuel Savings

$$\Delta Therms_{Peak} = N/A$$

Lifetime Energy Savings Algorithms:

Lifetime Electric Energy Savings

$$\Delta kWh_{Life} = \Delta kWh \times EUL$$

Lifetime Fuel Savings

$$\Delta Therms_{Life} = N/A$$

Dual:

Lifetime Electric Energy Savings

$$\Delta kWh_{Life} = \Delta kWh_{EREP} \times RUL + \Delta kWh_{NR} \times EUL$$

Lifetime Fuel Savings

$$\Delta Therms_{Life} = N/A$$

Calculation Parameters

Table 2-103 Calculation Parameters

Variable	Description	Value	Units	Ref
ΔkWh	Annual electric energy savings	Calculated	kWh/yr	
ΔkW_{Peak}	Peak Demand Savings	Calculated	kW	
ΔkWh_{Life}	Lifetime electric energy savings	Calculated	kWh	
ΔkWh_h	Annual heating electric energy savings	Calculated	kWh/yr	
ΔkWh_c	Annual cooling electric energy savings	Calculated	kWh/yr	
kW_{motor}	Motor full load electric demand	Calculated, if HP is unknown use 0.377	kW	
HP	Horsepower of blower motor	Site specific, if unknown use 0.5 ²⁷	HP	

²⁷ Typical blower motor capacity for gas furnace is 1/4 to 3/4 HP, Avg of 1/2 HP =0.377kW.

Variable	Description	Value	Units	Ref
EFLH _h	Equivalent Full Load Hours of operation for the average unit during the heating season	965	Hours	[143]
EFLH _c	Equivalent Full Load Hours of operation for the average unit during the cooling season	600	Hours	[144]
EI	Efficiency Improvement	15%	N/A	[145]
ISR	In-service rate	Site specific. Default for Kits = 15%, Default for Direct Install = 100%	N/A	[146]
CF	Electric coincidence factor	Look up in Table 2-104	N/A	
PDF	Gas peak demand factor	Look up in Table 2-104	N/A	
EUL	Effective useful life	See Measure Life Section	Years	[148]
0.746	Conversion factor for HP to kWh	0.746	kW/HP	

Peak Factors

Table 2-104 Peak Factors

Peak Factor	Value	Ref
Electric coincidence factor (CF)	0.69	[147]
Natural gas peak day factor (PDF)	N/A	

Measure Life

The remaining useful life (RUL) for existing equipment is limited to 1/3 of the effective useful life (EUL) of the equipment.

Table 2-105 Measure Life

Equipment	EUL	RUL	Ref
Filter Whistle	5	1.67	[148]

References

- [143] NJ utility analysis of heating customers, annual gas usage
- [144] VEIC Estimate. Consistent with analysis of PEPCo and LIPA, and conservative relative to ARI.
- [145] Energy.gov *Maintaining Your Air Conditioner* (Accessed 12/16/2022), Says that replacing a dirty air filter with a clean one can lower total air conditioner energy consumption by 5-15%. Since the algorithms in this measure only take into account the blower fan energy use, a 15% savings seems reasonable.
<https://www.energy.gov/energysaver/maintaining-your-air-conditioner>
- [146] The In Service Rate is the average of values reported by FirstEnergy EDCs for kits including an air handler furnace whistle for PY9. See
http://www.puc.pa.gov/filing_resources/issues_laws_regulations/act_129_information/electric_distribution_company_act_129_reporting_requirements.aspx

- [147] Per NY TRM: "Based on BG&E 'Development of Residential Load Profile for Central Air Conditioners and Heat Pumps' research, the Maryland Peak Definition coincidence factor is 0.69. This study is not publicly available, but is referenced by M. M. Straub, Using Available Information for Efficient Evaluation of Demand-Side Management Programs, Electricity Journal, September 2011 and supported by research conducted by Cadmus on behalf of the RM Management Committee."
- [148] DEER 2020 <http://www.deeresources.com/files/DEER2020/download/SupportTable-EUL2020.xlsx>

2.3.11 CEILING FAN

Market	Residential/Multifamily/Low-Income
Baseline Condition	TOS/DI
Baseline	Existing/Dual
End Use Subcategory	Ceiling Fan
Measure Last Reviewed	December 2022

Description

This section provides energy savings algorithms for the installation of an ENERGY STAR v4.0 ceiling fan/light unit in residential settings. These units are known to be 60% more efficient than conventional units due to improved motors and blade design [149].

Since the savings from this measure are derived from more efficient ventilation and lighting, which have very different load shapes and measure life, the savings are split by component and claimed together.

Baseline Case

Conventional ceiling fan/light unit with EISA qualified incandescent or halogen light bulbs.

Efficient Case

An ENERGY STAR v4.0 certified ceiling fan/lighting unit with LED bulbs.

Annual Energy Savings Algorithm

Annual Electric Energy Savings

$$\Delta kWh = \Delta kWh_{fan} + \Delta kWh_{light}$$

Where,

$$\Delta kWh_{fan} = \frac{\text{Days} \times \text{Hrs}_{fan} \times [(F_{low,b} \times W_{low,b}) + (F_{med,b} \times W_{med,b}) + (F_{high,b} \times W_{high,b})]}{1,000} - \frac{\text{Days} \times \text{Hrs}_{fan} \times [(F_{low,q} \times W_{low,q}) + (F_{med,q} \times W_{med,q}) + (F_{high,q} \times W_{high,q})]}{1,000}$$

$$\Delta kWh_{light} = \frac{W_{b,light} - W_{q,light}}{1,000} \times \text{Hrs}_{light} \times (1 + HVAC_e)$$

Annual Fuel Savings

Heating Penalty from improved lighting:

$$\Delta Therms = - \frac{W_{b,light} - W_{q,light}}{1,000} \times Hrs_{light} \times HF \times \frac{0.03412}{Eff_{heat}} \times F_{FH}$$

Peak Demand Savings

$$\Delta kW_{Peak} = \Delta kW_{fan} + \Delta kW_{light}$$

Where,

$$\Delta kW_{fan} = \frac{W_{high,b} - W_{high,q}}{1,000} \times CF_{fan}$$

$$\Delta kW_{light} = \frac{W_{b,light} - W_{q,light}}{1,000} \times CF_{light} \times (1 + HVAC_d)$$

Daily Peak Fuel Savings

$$\Delta Therms_{Peak} = \Delta Therms \times PDF$$

Lifetime Energy Savings Algorithms:

Lifetime Electric Energy Savings

$$\Delta kWh_{Life} = \Delta kWh \times EUL$$

Lifetime Fuel Savings

$$\Delta Therms_{Life} = \Delta Therms \times EUL$$

Dual:

Lifetime Electric Energy Savings

$$\Delta kWh_{Life} = \Delta kWh_{EREP} \times RUL + \Delta kWh_{NR} \times EUL$$

Lifetime Fuel Savings

$$\Delta Therms_{Life} = \Delta Therms_{EREP} \times RUL + \Delta Therms_{NR} \times EUL$$

Calculation Parameters

Table 2-106 Calculation Parameters

Variable	Description	Value	Units	Ref
ΔkWh	Annual electric energy savings	Calculated	kWh/yr	
ΔTherms	Annual fuel savings	Calculated	Therms/yr	
ΔkW _{Peak}	Peak Demand Savings	Calculated	kW	
ΔkWh _{fan}	Annual ceiling fan savings	Calculated	kWh/yr	
ΔkWh _{light}	Annual light savings	Calculated	kWh/yr	

Variable	Description	Value	Units	Ref
ΔkW_{fan}	Annual fan peak demand savings	Calculated	kW	
ΔkW_{light}	Annual light peak demand savings	Calculated	kW	
$\Delta Therms_{Peak}$	Daily peak fuel savings	Calculated	Therms/day	
ΔkWh_{Life}	Lifetime electric energy savings	Calculated	kWh	
$\Delta Therms_{Life}$	Lifetime fuel savings	Calculated	Therms	
Days	Days used per year	Site-specific, if unknown use 365.25	Days/yr	[152]
Hrs_{fan}	Daily Fan "On Hours"	Site-specific, if unknown use 3	Hrs/day	[152]
$W_{low,b}$	Fan wattage at Low speed of baseline	Site-specific, if unknown use 15	Watts	[152]
$W_{med,b}$	Fan wattage at Medium speed of baseline	Site-specific, if unknown use 34	Watts	[152]
$W_{high,b}$	Fan wattage at High speed of baseline	Site-specific, if unknown use 67	Watts	[152]
$W_{low,q}$	Fan wattage at Low speed of ENERGY STAR	Site-specific, if unknown use 6	Watts	[152]
$W_{med,q}$	Fan wattage at Medium speed of ENERGY STAR	Site-specific, if unknown use 23	Watts	[152]
$W_{high,q}$	Fan wattage at High speed of ENERGY STAR	Site-specific, if unknown use 56	Watts	[152]
$W_{b,light}$	Total lighting wattage of baseline fixture	Site-specific; if unknown use 129W	Watts	[152]
$W_{q,light}$	Total lighting wattage of energy efficient fixture	Site-specific; if unknown use 42W	Watts	[152]
F_{FH}	Fraction of homes using fossil fuel heat	Site-specific; if unknown use 0.8	N/A	
$F_{low,b}$	Fraction of time spent at Low speed of baseline	0.4	N/A	[152]
$F_{med,b}$	Fraction of time spent at Medium speed of baseline	0.4	N/A	[152]
$F_{high,b}$	Fraction of time spent at High speed of baseline	0.2	N/A	[152]
$F_{low,q}$	Fraction of time spent at Low speed of ENERGY STAR	0.4	N/A	[152]
$F_{med,q}$	Fraction of time spent at Medium speed of ENERGY STAR	0.4	N/A	[152]
$F_{high,q}$	Fraction of time spent at High speed of ENERGY STAR	0.2	N/A	[152]

Variable	Description	Value	Units	Ref
1,000	Conversion from W to kW	1,000	W/kW	
Hrs _{light}	Lighting hours of operation	Look up in Table 2-107	Hrs/yr	[150][151]
HVAC _e	HVAC Interactive Factor for Annual Energy Savings	Look up in Table 2-107	N/A	[150]
HVAC _d	HVAC Interactive Factor for Peak Demand Savings	Look up in Table 2-107	N/A	[150]
HF	Heating Factor	0.47	N/A	
Eff _{heat}	Efficiency of heating system	0.8	N/A	
CF	Electric coincidence factor	Look up in Table 2-108	N/A	
PDF	Gas peak demand factor	Look up in Table 2-108	N/A	
EUL	Effective useful life of new unit	See Measure Life Section	Years	
RUL	Remaining useful life of existing unit	See Measure Life Section	Years	

Table 2-107 Lighting Hours, Interactive Factors

Installation Location	Hrs	HVAC _e ²⁸	HVAC _d ²⁹
Interior	679	0.023	0.155
Exterior	1643	0	0
Unknown	808	0.020	0.134

Peak Factors

Table 2-108 Peak Factors

Peak Factor	Value	Ref
Fan coincidence factor (CF _{fan})	0.3	[153]
Light coincidence factor (CF _{light})	0.06	[150]
Natural gas peak day factor (PDF)	N/A	N/A

²⁸ For electric cooling interactivity, value based on NEEP Mid-Atlantic TRM V9, p. 22: Calculated using defaults assuming 89% of homes have electric cooling (per RECS 2015 data) with an average 3.8 COP and a cooling load reduction of 33% of lighting savings; $0.89 \times (0.33 / 3.8) = 0.077$.

For electric heating interactivity, value based on NEEP Mid-Atlantic TRM V9, p. 22: Calculated using defaults assuming 20% of homes are electrically heated (per RECS 2015 data) with an average 1.74 COP and a heating load increase of 47% of lighting savings; $-0.20 \times (0.47 / 1.74) = -0.054$. Value of HVAC_e established as the summation of these values; $0.077 - 0.054 = 0.023$.

²⁹ From NEEP Mid-Atlantic TRM V9, p. 24: Calculated using defaults assuming 89% of homes have electric cooling (per RECS 2015 data) with an average 3.8 COP and peak cooling load reduction of 66% of lighting savings; $0.89 \times (0.66 / 3.8) = 0.155$.

Measure Life

The remaining useful life (RUL) for existing equipment is limited to 1/3 of the effective useful life (EUL) of the equipment.

Table 2-109 Measure Life

Equipment	EUL	RUL	Ref
Ceiling Fan	15	5	[150]

References

- [149] "Ceiling Fans." n.d. Wwww.energystar.gov. https://www.energystar.gov/products/ceiling_fans.
- [150] "MID-ATLANTIC TECHNICAL REFERENCE MANUAL VERSION 9." n.d. Accessed November 23, 2022. [https://neep.org/sites/default/files/resources/Mid Atlantic TRM V9 Final clean wUpdateSummary%20-%20OCT%20FORMAT.pdf](https://neep.org/sites/default/files/resources/Mid%20Atlantic%20TRM%20V9%20Final%20clean%20wUpdateSummary%20-%20OCT%20FORMAT.pdf) .
- [151] DNV KEMA Energy and Sustainability, Pacific Northwest National Laboratory, *Residential Lighting End-Use Consumption Study: Estimation Framework and Initial Estimates*. (US DOE, 2012), Table 4.4, https://www1.eere.energy.gov/buildings/publications/pdfs/ssl/2012_residential-lighting-study.pdf
- [152] https://www.energystar.gov/sites/default/files/asset/document/light_fixture_ceiling_fan_calculator.xlsx
- [153] Assuming that the CF for a ceiling fan is the same as Room AC; Consistent with coincidence factors found in: *RLW Report: Final Report Coincidence Factor Study Residential Room Air Conditioners*, (June 23, 2008) http://www.puc.nh.gov/Electric/Monitoring%20and%20Evaluation%20Reports/National%20Grid/117_RLW_CF%20Res%20RAC.pdf

2.3.12 SMART THERMOSTAT

Market	Residential/Multifamily
Baseline Condition	RF/DI/TOS
Baseline	Existing/Dual
End Use Subcategory	Control
Measure Last Reviewed	January 2023

Description

This measure covers the installation of Smart or Connected ENERGY STAR® V1.0³⁰ thermostats applied to single-family and multi-family residential HVAC systems. A “smart” thermostat that is ENERGY STAR® certified has the following properties [156].

- Automatic scheduling
- Occupancy sensing (set “on” as a default)
- For homes with a heat pump, smart thermostats must be capable of controlling heat pumps to optimize energy use and minimize the use of backup electric resistance heat.
- Ability to adjust settings remotely via a smart phone or online the absence of connectivity to the connected thermostat (CT) service provider, retain the ability for residents to locally:
 - View the room temperature,
 - View and adjust the set temperature, and
 - Switch between off, heating and cooling
- Have a static temperature accuracy $\leq \pm 2.0$ °F
- Have network standby average power consumption of ≤ 3.0 W average (Includes all equipment necessary to establish connectivity to the CT service provider’s cloud, except those that can reasonably be expected to be present in the home, such as Wi-Fi routers and smart phones.)
- Enter network standby after ≤ 5.0 minutes from user interaction (on device, remote or occupancy detection)
- The following capabilities may be enabled through the CT device, CT service or any combination of the two. The CT product shall maintain these capabilities through subsequent firmware and software changes.
 - Ability for consumers to set and modify a schedule.
 - Provision of feedback to occupants about the energy impact of their choice of settings.

³⁰ ENERGY STAR® V2.0 Connected Thermostats is under development.

- Ability for consumers to access information relevant to their HVAC energy consumption, e.g. HVAC run time.

Baseline Case

Mix of standard non-programmable and programmable thermostats for central heating and cooling systems

Efficient Case

Smart Thermostat meeting the measure description above.

Annual Energy Savings Algorithms

Annual Electric Energy Savings

$$\Delta kWh = \Delta kWh_{cool} + \Delta kWh_{heat}$$

Where,

$$\Delta kWh_{cool} = \left(Cap_c \times EFLH_{cool} \times \frac{1}{SEER} \times SF_{elec,c} \times F_{elecCool} \right)$$

$$\Delta kWh_{heat} = \left(Cap_{h,out} \times EFLH_{heat} \times \frac{1}{HSPF} \times SF_{elec,h} \times F_{elecHeat} \right)$$

Annual Fuel Savings

$$\Delta Therms = Cap_{h,fuel} \times EFLH_{heat} \times \frac{1}{AFUE} \times SF_{fuel} \times F_{fuelHeat} \times \frac{1}{100}$$

Peak Demand Savings

$$\Delta kW_{Peak} = N/A$$

Daily Peak Fuel Savings

$$\Delta Therms_{Peak} = \Delta Therms \times PDF$$

Lifetime Energy Savings Algorithms

Lifetime Electric Energy Savings

$$\Delta kWh_{Life} = \Delta kWh \times EUL$$

Lifetime Fuel Savings

$$\Delta Therms_{Life} = \Delta Therms \times EUL$$

Dual:

Lifetime Electric Energy Savings

$$\Delta kWh_{Life} = \Delta kWh_{EREP} \times RUL + \Delta kWh_{NR} \times EUL$$

Lifetime Fuel Savings

$$\Delta Therms_{Life} = \Delta Therms_{EREP} \times RUL + \Delta Therms_{NR} \times EUL$$

Calculation Parameters

Table 2-110 Calculation Parameters

Variable	Description	Value	Units	Ref
ΔkWh	Annual electric energy savings	Calculated	kWh/yr	
$\Delta Therms$	Annual fuel savings	Calculated	Therms/yr	
$\Delta Therms_{Peak}$	Daily peak fuel savings	Calculated	Therms/day	
ΔkWh_{Life}	Lifetime electric energy savings	Calculated	kWh	
$\Delta Therms_{Life}$	Lifetime fuel savings	Calculated	Therms	
ΔkWh_{cool}	Cooling electric savings	Calculated	kWh/yr	
ΔkWh_{heat}	Heating electric savings	Calculated	kWh/yr	
Cap_c	Tons of air conditioning per residence	Site-specific, if unknown use 3 tons ³¹	Tons/unit	
SEER	Seasonal energy efficiency ratio of cooling unit (SEER/SEER2)	Site-specific, if unknown, look up in Appendix C: Heating and Cooling EFLH	Btu/W-h	[154]
$EFLH_{cool}$	Equivalent full load hours of operation during cooling season	Look up in Appendix C: Heating and Cooling EFLH	Hours	[155]
$SF_{elec,c}$	Cooling energy savings factor	0.07	N/A	[159]
$F_{elecCool}$	Electric cooling factor; used to account for the presence or absence of an electric cooling system	Electric Cooling: 1 No Electric Cooling: 0 Unknown: 0.39	N/A	[157]
$Cap_{h,out}$	Output heating capacity in kBtu/h per residence	Site-specific, if unknown use 72 kBtu/hr ³²	kBTU/hr	
$Cap_{h,fuel}$	Heating capacity in of existing fossil heat unit	Site-specific	kBTU/hr	
HSPF	Heating seasonal performance factor of heating unit (HSPF/HSPF2) if rated in COP, convert using HSPF = COP x 3.412	Site-specific, if unknown look up in Appendix E: Code-Compliant Efficiencies	Btu/W-h	[154]
$EFLH_{heat}$	Equivalent full load hours of operation during heating season	See Appendix C:	Hours	[155]

³¹ Assumes a 1,800 ft² home with 20 BTU/h-ft² cooling load: 1,800 ft² x 20 BTU/h-ft² x 1/12,000 ton/(BTU/h) = 3 tons

³² Assumes a 1,800 ft² home with 40 BTU/h-ft² heating load: 1,800 ft² x 40 BTU/h-ft² x 1/(1,000 kBtu/h)/(BTU/h) = 72 kBtu/h

Variable	Description	Value	Units	Ref
AFUE	Annual fuel utilization efficiency	Site-specific, if unknown look up in Appendix E: Code-Compliant Efficiencies		
S _{F_{fuel}}	Fuel heating energy savings factor	0.06	N/A	[159]
S _{F_{elec,h}}	Electric heating energy savings factor	0.06	N/A	[159]
F _{elecHeat}	Electric heating factor; used to account for the presence or absence of an electric heating system	Electric Heating: 1 No Electric Heating: 0 Unknown: 0.15	N/A	[158]
F _{FuelHeat}	Fossil fuel heating factor; used to account for the presence or absence of a fossil fuel heating system	Fossil Fuel Heating: 1 No Fossil Fuel Heating: 0 Unknown: 0.91	N/A	[158]
100	Conversion factor, kBTU to therms	100	kBTU/therms	
CF	Electric coincidence factor	Look up in Table 2-111	N/A	
PDF	Gas peak day factor	Look up in Table 2-111	N/A	
EUL	Effective useful life	See Measure Life Section	Years	

Peak Factors

Table 2-111 Peak Factors

Peak Factor	Value	Ref
Electric coincidence factor (CF)	N/A	
Natural gas peak day factor (PDF)	See Appendix G: Natural Gas Peak Day Factors	

Measure Life

This measure is being applied to existing operational equipment. Hence, the effective useful life (EUL) is the smaller of the host equipment remaining life or the full measure life of upgrade which is 5 years [160].

References

- [154] “2012 INTERNATIONAL ENERGY CONSERVATION CODE (IECC) | ICC DIGITAL CODES.” n.d. Codes.iccsafe.org. Accessed January 23, 2023 <https://codes.iccsafe.org/content/IECC2012P5/chapter-4-ce-commercial-energy-efficiency>
- [155] Simulations of prototype buildings from NY TRM updated with NJ weather done by NJ Statewide Evaluator, May 2022
- [156] *ENERGY STAR® Program Requirements Product Specification for Connected Thermostat Products, Eligibility Criteria Version 1.0*, (January 2017), pg. 10

<https://www.energystar.gov/sites/default/files/asset/document/ENERGY%20STAR%20Program%20Requirements%20for%20Connected%20Thermostats%20Version%201.0.pdf>

[157] EIA Residential Energy Consumption Survey (RECS) 2015 for Middle Atlantic States, Table HC7.7

<https://www.eia.gov/consumption/residential/data/2015/hc/php/hc7.7.php>

[158] EIA Residential Energy Consumption Survey (RECS) 2015 for Middle Atlantic States, Table HC6.7

<https://www.eia.gov/consumption/residential/data/2015/hc/php/hc6.7.php>

[159] *TRM Mid-Atlantic Technical Reference Manual:Version 10* (NEEP, 2020), Pg 104, <https://neep.org/mid-atlantic-technical-reference-manual-trm-v10>

[160] California Public Utilities Commission Database for Energy Efficient Resources (DEER) EUL Support Table for 2020, <http://www.deeresources.com/files/DEER2020/download/SupportTable-EUL2020.xlsx>

2.4 LIGHTING

2.4.1 LAMPS AND FIXTURES

Market	Residential/Multifamily
Baseline Condition	TOS/NC/RF/EREP/ERET/DI
Baseline	Existing/Code
End Use Subcategory	Lighting
Measure Last Reviewed	November 2022

Description

This section provides energy saving algorithms for the installation of screw-in ENERGY STAR LED general service lamps, ENERGY STAR LED fixtures, ENERGY STAR specialty LED lamps, Nightlights, and Holiday Lights.

Savings from lamps and fixtures are based on the difference between the baseline lamp/fixture wattage and new lamp/fixture wattage, and the average daily hours of usage for the lighting unit being replaced.

For ENERGY STAR Lamps, baseline lamp/fixture wattage is based on the lumen output of the ENERGY STAR lamp/fixture and a minimum lamp/fixture lumen per watt efficacy. Using the relationship in this section, the baseline lamp wattage for General Service Lamps is installed lumens divided by 45 lumens per watt, compliant with Federal regulations issued on May 8, 2022 and New Jersey P.L. 2021, c. 464 minimum standards[168]. Full compliance with this standard by retailers shall commence on August 1, 2023[167].

Baseline Case

ENERGY STAR Lamps and Fixtures: Baseline wattage assumed to equal to the installed lumens divided by 45 lumens per watt for general service bulbs in kits and retail distribution. For direct install lights exempt from or installed prior to enforcement of the EISA requirement, if the site-specific baseline wattage is unknown, use the baseline wattage assumptions in Table 2-114, Table 2-115, and Table 2-116.

Nightlights: Non LED Nightlights, assumed 6.75 watts.

Holiday Lights: Traditional incandescent holiday lights with a wattage higher than the LED wattage. For incandescent mini-bulbs, incandescent C7 bulbs, and incandescent C9 bulbs, assume baselines of 0.48, 6, and 7 watts per bulb respectively.

Efficient Case

ENERGY STAR Lamps and Fixtures: Qualifying Lamp/Fixture ENERGY STAR wattage

Nightlights: Qualifying LED Nightlight wattage.

Holiday Lights: Qualifying LED Holiday Lights wattage.

Annual Energy Savings Algorithm

Annual Electric Energy Savings

ENERGY STAR Lamps and Fixtures:

$$\Delta kWh = N_q \times \frac{W_{b,ES} - W_{q,ES}}{1,000} \times Hrs_{ES} \times (1 + HVAC_e) \times ISR$$

Where,

$$W_{b,ES} = \frac{Lumen_q}{45}$$

Nightlights:

$$\Delta kWh = \frac{W_{NL} \times H_{NL,daily} \times 365}{1,000}$$

Holiday Lights:

$$\Delta kWh = [F_{C9} \times \Delta kWh_{C9}] + [F_{C7} \times \Delta kWh_{C7}] + [F_{mini} \times \Delta kWh_{mini}]$$

Where,

$$\Delta kWh_{C9} = \frac{[(W_{b,C9} - W_{q,C9}) \times N_{bulbs} \times N_{strands} \times Hrs_{HL}]}{1000}$$

$$\Delta kWh_{C7} = \frac{[(W_{b,C7} - W_{q,C7}) \times N_{bulbs} \times N_{strands} \times Hrs_{HL}]}{1000}$$

$$\Delta kWh_{mini} = \frac{[(W_{b,mini} - W_{q,mini}) \times N_{bulbs} \times N_{strands} \times Hrs_{HL}]}{1000}$$

Annual Fuel Savings

ENERGY STAR Lamps and Fixtures:

$$\Delta Therms = -N_q \times \frac{W_{b,ES} - W_{q,ES}}{1,000} \times \frac{Watts}{kW} \times Hrs \times HVAC_g \times \frac{0.03412}{Eff_{heat}} \times F_{FH}$$

No fuel savings associated with Nightlights and Holiday Lights.

Peak Demand Savings

ENERGY STAR Lamps and Fixtures:

$$\Delta kW_{Peak} = N_q \times \frac{W_{b,ES} - W_{q,ES}}{1,000} \times CF \times (1 + HVAC_d)$$

No Peak Demand Savings associated with Nightlights and Holiday Lights.

Daily Peak Fuel Savings

$$\Delta Therms_{Peak} = \Delta Therms \times PDF$$

Lifetime Energy Savings Algorithms

Lifetime Electric Energy Savings

$$\Delta kWh_{Life} = \Delta kWh \times EUL$$

Lifetime Fuel Savings

$$\Delta Therms_{Life} = \Delta Therms \times EUL$$

Calculation Parameters

Table 2-112 Calculation Parameters

Variable	Description	Value	Units	Ref
ΔkWh	Annual electric energy savings	Calculated	kWh/yr	
$\Delta Therms$	Annual fuel savings	Calculated	Therms/yr	
ΔkW_{Peak}	Peak Demand Savings	Calculated	kW	
$\Delta therms_{Peak}$	Daily peak fuel savings	Calculated	Therms/day	
N_q	Quantity of energy efficient fixtures	Site-specific	N/A	
$W_{b,ES}$	Wattage of baseline fixture	Direct Install: Site-specific Exempt from EISA Compliance: Look up in Table 2-114, Table 2-115, Table 2-116 EISA Compliant: Calculated	kW	[171]
$W_{q,ES}$	Wattage of energy efficient fixture	Site-specific	kW	
$Lumens_q$	Lumens of energy efficient fixture	Site-specific	Lumens	
F_{mini}	Percentage of holiday lights that are "mini"	Site-specific, if unknown use 0.5	%	[165]
F_{C7}	Percentage of holiday lights that are "C7"	Site-specific, if unknown use 0.25	%	[165]
F_{C9}	Percentage of holiday lights that are "C9"	Site-specific, if unknown use 0.25	%	[165]
N_{bulbs}	Number of bulbs per strand	Site-specific, if unknown use 50	Bulbs/Strand	[166]
$N_{strands}$	Number of strands of lights per package	Site-specific, if unknown use 1	Strands/package	[166]
Hrs_{ES}	Annual Hours of Operation	Look up in Table 2-113	Hrs/yr	[161][162]

Variable	Description	Value	Units	Ref
HVAC _e	HVAC Interactive Factor for Annual Energy Savings	Look up in Table 2-113	N/A	[161]
HVAC _d	HVAC Interactive Factor for Peak Demand Savings	Look up in Table 2-113	N/A	[161]
HVAC _g	Heating factor, or percentage of lighting savings that must be heated	Look up in Table 2-113	N/A	[161]
ISR	In-service rate	0.92	N/A	
Eff_{heat}	Efficiency of heating system	0.8	N/A	[170]
F _{FH}	Fraction of homes using fossil fuel heat	0.8	N/A	[169]
W _{NL}	Average watts replaced for an LED nightlight installation	6.75	W	[163]
Hrs _{NL,daily}	Average daily burn time for LED nightlight replacements	12	hrs	[164]
365	Days per year	365	Day/yr	
1,000	Conversion from watts to kW	1,000	W/kW	
W _{q,mini}	Wattage of LED mini bulbs	0.08	W/Bulb	[165]
W _{b,mini}	Wattage of incandescent mini bulbs	0.48	W/Bulb	[165]
W _{q,C7}	Wattage of LED C7 bulbs	0.48	W/Bulb	[165]
W _{b,C7}	Wattage of incandescent C7 bulbs	6	W/Bulb	[165]
W _{q,C9}	Wattage of LED C9 bulbs	2	W/Bulb	[165]
W _{b,C9}	Wattage of incandescent C9 bulbs	7	W/Bulb	[165]
45	Conversion from lumens of energy efficient fixture to wattage of baseline fixture	45	Lumens/watt	
Hrs _{HL}	Annual hours of operation for Holiday Lights	150	Hrs/yr	[165]
CF	Electric coincidence factor	Look up in Table 2-117	N/A	
PDF	Gas peak day factor	Look up in Table 2-117	N/A	
EUL	Effective useful life	See	Years	

Table 2-113 Hours, Interactive Factors, and Heating Factor

Installation Location	Hrs	HVAC _e ³³	HVAC _d ³⁴	HVAC _g
Interior	679	0.023	0.155	0.47
Exterior	1643	0	0	0
Unknown	808	0.020	0.134	0.41

Table 2-114 Exempt Standard Lamp Baselines

Bulb Type	Lumen Range	W _{b,ES}
A-Lamp (A15, A17, A19, A21)	< 310	Use ENERGY STAR Watts Equivalent
	310 – 749	40
	750 – 1,049	60
	1,050 – 1,489	75
	1,490 – 2,600	100
	> 2,600	Use ENERGY STAR Watts Equivalent

Table 2-115 Exempt Specialty Lamps Baseline

Bulb Type	Base Type	Lumen Range	W _{b,ES}
Globe All G (G30, G25, G16.5)	E26 and E17	< 90	Use ENERGY STAR Watts Equivalent
		90 – 179	10
		180 – 249	20
		250 – 349	25
		350 – 749	40
		750 – 1,049	43
		1,050 – 1,489	53
		1,490 – 2,600	72
	> 2,600	Use ENERGY STAR Watts Equivalent	
	E12 (Candelabra)	< 90	Use ENERGY STAR Watts Equivalent
		90 – 179	10
		180 – 249	20
		250 – 349	25
		350 – 499	40
500 – 1,049		60	

³³ For electric cooling interactivity, value based on NEEP Mid-Atlantic TRM V9, p. 22: Calculated using defaults assuming 89% of homes have electric cooling (per RECS 2015 data) with an average 3.8 COP and a cooling load reduction of 33% of lighting savings; $0.89 \times (0.33 / 3.8) = 0.077$.

For electric heating interactivity, value based on NEEP Mid-Atlantic TRM V9, p. 22: Calculated using defaults assuming 20% of homes are electrically heated (per RECS 2015 data) with an average 1.74 COP and a heating load increase of 47% of lighting savings; $-0.20 \times (0.47 / 1.74) = -0.054$. Value of HVAC_e established as the summation of these values; $0.077 - 0.054 = 0.023$.

³⁴ From NEEP Mid-Atlantic TRM V9, p. 24: Calculated using defaults assuming 89% of homes have electric cooling (per RECS 2015 data) with an average 3.8 COP and peak cooling load reduction of 66% of lighting savings; $0.89 \times (0.66 / 3.8) = 0.155$.

Bulb Type	Base Type	Lumen Range	W _{b,ES}
		> 1,049	Use ENERGY STAR Watts Equivalent
		< 90	Use ENERGY STAR Watts Equivalent
Globe (G40)	E26 (Medium), E17, and E12	90 – 179	10
		180 – 249	20
		250 – 349	25
		350 – 499	40
		500 – 1,049	60
		> 1,049	Use ENERGY STAR Watts Equivalent

Bulb Type	Base Type	Lumen Range	W _{b,ES}
Decorative (Shapes B10, B11, B13, BA10, BA11, CA10, C7, C9, F10, F15, ST, S14)	E26 (Medium) and E17	< 70	Use ENERGY STAR Watts Equivalent
		70 – 89	10
		90 – 149	15
		150 – 299	25
		300 – 749	40
		750 – 1,049	43
		1050 – 1,489	53
		1,490 – 2,600	72
	> 2,600	Use ENERGY STAR Watts Equivalent	
	Candelabra base E12	< 70	Use ENERGY STAR Watts Equivalent
		70 – 89	10
		90 – 149	15
		150 – 299	25
		300 – 449	40
450 – 1,049		60	
> 1,049	Use ENERGY STAR Watts Equivalent		

Table 2-116 Exempt Reflector/Flood Lamps Baseline

Bulb Type	Lumen Range	W _{b,ES}
R20	200 - 299	30
	300 – 718	45
	719 – 810	50
	811 – 1,002	55
	1,003 – 1,202	65
	1,203 – 1,516	75
	1,517 – 1,733	90
	1,734 – 2,184	100
	> 2,184	120
PAR20	200 - 299	30
	300 – 718	40
	719 – 810	50
	811 – 1,002	55
	1,003 – 1,202	65
	1,203 – 1,516	75
	1,517 – 1,733	90
	1,734 – 2,184	100

	> 2,184	120
BR30, BR40, ER40	200 – 299	30
	300 – 399	40
	400 – 649	50
	650 – 1,419	65
	1,420 – 1,789	75
	1,790 – 2,045	90
	2,046 – 2,578	100
	> 2,578	120
ER30	200 – 299	30
	300 – 399	40
	400 – 956	50
	957 – 1183	55
	1184 – 1419	65
	1420 – 1789	75
	1790 – 2045	90
	2046 – 2578	100
	> 2578	120
PAR30, PAR38, R40	639 – 847	40
	848 – 956	50
	957 – 1,183	55
	1,184 – 1,419	65
	1,420 – 1,789	75
	1,790 – 2,045	90
	2,046 – 2,578	100
	> 2,578	120
R14, PAR16, R16	200 – 299	30
	300 – 399	40
	400 – 499	50
	500 – 599	60
	600 – 1,000	65
MR16	< 450	35
	450 – 600	50

	> 600	75
For any lamps/bulb types for reflector lamps not captured in the criteria above	All	Use ENERGY STAR Watts Equivalent

Peak Factors

Table 2-117 Peak Factors

Peak Factor	Value	Ref
Electric coincidence factor (CF)	0.06	[161]
Natural gas peak day factor (PDF)	N/A	

Measure Life

The remaining useful life (RUL) for existing equipment is limited to 1/3 of the effective useful life (EUL) of the equipment.

Table 2-118 Measure Life

Equipment	EUL	RUL	Ref
Lamps and Fixtures	15	5	[172][173]

References

- [161] “MID-ATLANTIC TECHNICAL REFERENCE MANUAL VERSION 9.” n.d. Accessed November 23, 2022. [https://neep.org/sites/default/files/resources/Mid Atlantic TRM V9 Final clean wUpdateSummary%20-%20OCT%20FORMAT.pdf](https://neep.org/sites/default/files/resources/Mid%20Atlantic%20TRM%20V9%20Final%20clean%20wUpdateSummary%20-%20OCT%20FORMAT.pdf) .
- [162] DNV KEMA Energy and Sustainability, Pacific Northwest National Laboratory, *Residential Lighting End-Use Consumption Study: Estimation Framework and Initial Estimates*. (US DOE, 2012), Table 4.4, https://www1.eere.energy.gov/buildings/publications/pdfs/ssl/2012_residential-lighting-study.pdf
- [163] Jackie Berger, *NJ Comfort Partners Energy Saving Protocols and Engineering Estimates*. (Applied Public Policy Research Institute for Study and Evaluation (APPRISE), 2014), Pg 21, <https://www.njcleanenergy.com/files/file/Protocol%20and%20Engineering%20Estimate%20Summary.pdf> .
- [164] *Southern California Edison Company, LED, Electroluminescent & Fluorescent Night Lights: Work Paper WPSCRELG0029 Rev.1*, (February 2009), pp. 2–3
- [165] The DSMore Michigan Database of Energy Efficiency Measures: Based on spreadsheet calculations using collected data
- [166] Typical values of lights per strand and strands per package at Home Depot and other stores
- [167] “Regulations.gov.” n.d. Wwww.regulations.gov. Accessed December 1, 2022. <https://www.regulations.gov/document/EERE-2021-BT-STD-0012-0022>.
- [168] “New Jersey A5160 | 2020-2021 | Regular Session.” n.d. LegiScan. Accessed December 1, 2022. <https://legiscan.com/NJ/bill/A5160/2020>.
- [169] <https://www.ecfr.gov/current/title-10/chapter-II/subchapter-D/part-430#430.32>
- [170] Based on RECS 2015 data for Middle Atlantic Region (Table HC6.7).

- [171] New York Standard Approach for Estimating Energy Savings from Energy Efficiency Programs – Version 10. (New York State Joint Utilities, 2022), Pg 341-344,
[https://www3.dps.ny.gov/W/PSCWeb.nsf/96f0fec0b45a3c6485257688006a701a/72c23decff52920a85257f1100671bdd/\\$FILE/NYS%20TRM%20V10.pdf](https://www3.dps.ny.gov/W/PSCWeb.nsf/96f0fec0b45a3c6485257688006a701a/72c23decff52920a85257f1100671bdd/$FILE/NYS%20TRM%20V10.pdf)
- [172] ENERGY STAR® Program Requirements Product Specification for Lamps (Light Bulbs) V2.1, June 2017, pg. 19 (Capped at 20 years).
<https://www.energystar.gov/sites/default/files/ENERGY%20STAR%20Lamps%20V2.1%20Final%20Specification.pdf>
- [173] ENERGY STAR® Program Requirements Product Specification for Luminaires (Light Fixtures) V2.2, August 2019, pg. 18 (Capped at 20 years).
<https://www.energystar.gov/sites/default/files/Luminaires%20V2.2%20Final%20Specification.pdf>

2.4.2 OCCUPANCY SENSOR

Market	Residential/Multi-Family
Baseline Condition	RF/DI/TOS
Baseline	Existing/Dual
End Use Subcategory	Control
Measure Last Reviewed	January 2023

Description

This measure defines the savings associated with installing a wall-mounted occupancy sensor that switches lights off after a brief delay when it does not detect occupancy.

Baseline Case

The baseline case is lighting controlled by a manual switch.

Efficient Case

The efficient condition is lighting that is controlled with an occupancy sensor. It is assumed that the controlled load is a mix of efficient and inefficient lighting.

Annual Energy Savings Algorithms

Annual Electric Energy Savings

$$\Delta kWh = (W_q/1,000) \times hrs \times SVG_e \times ISR \times (1 + HVAC_e)$$

Annual Fuel Savings

$$\Delta Therms = (W_q/1,000) \times hrs \times SVG_e \times ISR \times HVAC_g$$

Peak Demand Savings

$$\Delta kW_{Peak} = (W_q/1,000) \times SVG_d \times ISR \times CF \times (1 + HVAC_d)$$

Daily Peak Fuel Savings

$$\Delta Therms_{Peak} = \Delta Therms \times PDF$$

Lifetime Energy Savings Algorithms

Lifetime Electric Energy Savings

$$\Delta kWh_{Life} = \Delta kWh \times EUL$$

Lifetime Fuel Savings

$$\Delta Therms_{Life} = \Delta Therms \times EUL$$

Dual:

Lifetime Electric Energy Savings

$$\Delta kWh_{Life} = \Delta kWh_{EREP} \times RUL + \Delta kWh_{NR} \times EUL$$

Lifetime Fuel Savings

$$\Delta Therms_{Life} = \Delta Therms_{EREP} \times RUL + \Delta Therms_{NR} \times EUL$$

Calculation Parameters

Table 2-119 Calculation Parameters

Variable	Description	Value	Units	Ref
ΔkWh	Annual electric energy savings	Calculated	kWh/yr	
$\Delta Therms$	Annual fuel savings	Calculated	Therms/yr	
ΔkW_{Peak}	Peak Demand Savings	Calculated	kW	
$\Delta Therms_{Peak}$	Daily peak fuel savings	Calculated	Therms/day	
ΔkWh_{Life}	Lifetime electric energy savings	Calculated	kWh	
$\Delta Therms_{Life}$	Lifetime fuel savings	Calculated	Therms	
W_q	Total wattage of the fixture(s) being controlled by the occupancy sensor	Site specific, if unknown assume 105.5	W	
SVG_e	Percentage of annual lighting energy saved by lighting control	Site-specific, if unknown assume 0.49	N/A	[178]
ISR	In service rate or percentage of units rebated that get installed	Site-specific, if unknown use default = 0.98	N/A	[179]
SVG_d	Percentage of lighting demand saved by lighting control	Site specific, if unknown assume 0.49	N/A	
Hrs	Average hours of use per year	Look up in Table 2-120	Hours	[174][150] [175][176][177]
$HVAC_e$	HVAC Interactive Factor for Annual Energy Savings	Look up in Table 2-121	N/A	[177]
$HVAC_g$	HVAC Interactive Factor for Annual Fuel Savings	Look up in Table 2-121	N/A	[177]
$HVAC_d$	HVAC Interactive Factor for Peak Demand Savings	Look up in Table 2-121	N/A	[177]
1000	Unit Conversion, kW/Watts	1,000	kW/W	
CF	Electric coincidence factor	Look up in Table 2-122	N/A	

Variable	Description	Value	Units	Ref
PDF	Gas peak day factor	Look up in Table 2-122	N/A	
EUL	Effective useful life	See	Years	

Table 2-120 Hours

Installation Location	Annual Hours
Residential interior & in-unit Multi Family	679
Multi Family Common Areas	5,950
Unknown	679

Table 2-121 HVAC Interactive Factors, and Heating Factor

Installation Location	HVAC _e ³⁵	HVAC _d ³⁶	HVAC _g
Interior	0.023	0.155	-0.47
Exterior	0	0	0
Unknown	0.020	0.134	-0.41

Peak Factors

Table 2-122 Peak Factors

Peak Factor	Value	Ref
Electric coincidence factor (CF)	Lookup in Table 2-123	[181][182][183]
Natural gas peak day factor (PDF)	See Appendix G: Natural Gas Peak Day Factors	

Table 2-123 Summer Electric Peak Coincidence Factors

Installation Location	Type	Coincidence Factor (CF)
Residential interior and in-unit Multi Family	Utility Peak CF	0.059
	PJM CF	0.058
Multi Family Common Areas	PJM CF	0.86

³⁵ For electric cooling interactivity, value based on NEEP Mid-Atlantic TRM V9, p. 22: Calculated using defaults assuming 89% of homes have electric cooling (per RECS 2015 data) with an average 3.8 COP and a cooling load reduction of 33% of lighting savings; $0.89 \times (0.33 / 3.8) = 0.077$. For electric heating interactivity, value based on NEEP Mid-Atlantic TRM V9, p. 22: Calculated using defaults assuming 20% of homes are electrically heated (per RECS 2015 data) with an average 1.74 COP and a heating load increase of 47% of lighting savings; $-0.20 \times (0.47 / 1.74) = -0.054$. Value of HVAC_e established as the summation of these values; $0.077 - 0.054 = 0.023$.

³⁶ From NEEP Mid-Atlantic TRM V9, p. 24: Calculated using defaults assuming 89% of homes have electric cooling (per RECS 2015 data) with an average 3.8 COP and peak cooling load reduction of 66% of lighting savings; $0.89 \times (0.66 / 3.8) = 0.155$.

Installation Location	Type	Coincidence Factor (CF)
Exterior	PJM CF	0.018
Unknown	Utility Peak CF	0.059
	PJM CF	0.058

Measure Life

The remaining useful life (RUL) for existing equipment is limited to 1/3 of the effective useful life (EUL) of the equipment.

Table 2-124 Measure Life

Equipment	EUL	RUL	Ref
Occupancy Sensor	15	5	[184]

References

- [174] Based on Navigant Consulting, “EmPOWER Residential Lighting Program: 2016 Residential Lighting Inventory and Hours of Use Study” August 31, 2017, page 13. The HOU value is for an efficient lamp.
- [175] Multi family common area lighting assumption is 16.3 hours per day (5950 hours per year) based on Focus on Energy Evaluation, ACES Deemed Savings Desk Review, November 2010. This estimate is consistent with the Common Area “Non-Area Specific) assumption (16.2 hours per day or 5913 annually) from the Cadmus Group In., “Massachusetts Multifamily Program Impact Analysis”, July 2012, p 2-4.
- [176] Unknown” assumes a residential interior or in-unit multifamily application.
- [177] “MID-ATLANTIC TECHNICAL REFERENCE MANUAL VERSION 9.” n.d. Accessed November 23, 2022. [https://neep.org/sites/default/files/resources/Mid Atlantic TRM V9 Final clean wUpdateSummary%20-%20OCT%20FORMAT.pdf](https://neep.org/sites/default/files/resources/Mid%20Atlantic%20TRM%20V9%20Final%20clean%20wUpdateSummary%20-%20OCT%20FORMAT.pdf). [https://neep.org/sites/default/files/resources/NEEP CI Lighting LS FINAL Report ver 5 7-19-11 0.pdf](https://neep.org/sites/default/files/resources/NEEP%20CI%20Lighting%20LS%20FINAL%20Report%20ver%205%207-19-11%200.pdf)
- [178] Average of two studies. Navigant Consulting. Department of Energy Solid-State Lighting Program. Energy Savings Estimates of Solid-State Lighting in General Illumination Lighting Applications. September 2016. This study estimates a 71% energy savings from connected lighting in residential applications. (Table F-4). Efficiency Vermont. Smart Lighting & Smart Hub. DIY Install: Does it Yield. August 2016. This study estimates reductions in hours of use of up to 27%. Additionally, the metering study saw significant amounts of dimming of lamps that were on non-dimming circuits, but did not quantify the savings associated with this consumer action.
- [179] First year ISR of 0.9 (EMPOWER MD Lighting Study, EY5). Assume lifetime ISR of 0.99 (2006-2008 California Residential Lighting Evaluations, and used in the Uniform Methods Project). Assume half of bulbs not installed in year one are installed in year two, and the other half in year three. Using a discount rate of 5%, this gives $0.90 + 0.045 * 0.95 + 0.045 * 0.95^2 = 0.98$
- [180] The criteria that are used to determine whether equipment is “operational” vary among jurisdictions and there is no related industry standard practice. This TRM provides assumptions for estimating savings and costs for early replacement measures, but does not address this threshold question of whether a measure should be considered early replacement.
- [181] Based on Navigant Consulting “EmPOWER Residential Lighting Program: 2016 Residential Lighting Inventory and Hours of Use Study” August 31, 2017, page 15
- [182] Consistent with value currently used for EmPOWER Maryland Programs as of October 1, 2017. Derived from C&I common area lighting coincidence.

[183] Calculated from Itron eShapes, which is 8760 hourly data by end use for Upstate New York.

[184] Navigant, *ComEd Luminaire Level Lighting Control IPA Program Impact Evaluation Report* Table 8.1 Page 10 <https://icc.illinois.gov/docket/P2020-0486/documents/299941/files/523013.pdf>.

2.5 PLUG LOAD

2.5.1 OFFICE EQUIPMENT

Market	Residential/Multifamily/Low Income
Baseline Condition	TOS
Baseline	Code
End Use	Plug Load
Measure Last Reviewed	December 2022

Description

This section provides deemed savings for installing ENERGY STAR office equipment compared to standard efficiency equipment in residential and multifamily applications.

Per unit savings are primarily derived from the ENERGY STAR calculator for office equipment [185].

Baseline Case

The baseline condition is assumed to be standard equipment of similar type used in a residential setting.

Efficient Case

The efficient condition is ENERGY STAR equipment meeting ENERGY STAR v8 Eligibility Criteria [186] and used in a residential setting.

Annual Energy Savings Algorithm

Annual Electric Energy Savings

$$\Delta kWh = \text{Lookup in Table 2-126}$$

Annual Fuel Savings

$$\Delta Therms = N/A$$

Peak Demand Savings

$$\Delta kW_{Peak} = \text{Lookup in Table 2-126}$$

Daily Peak Fuel Savings

$$\Delta Therms_{Peak} = N/A$$

Lifetime Energy Savings Algorithms

Lifetime Electric Energy Savings

$$\Delta kWh_{Life} = \Delta kWh \times EUL$$

Lifetime Fuel Savings

$$\Delta Therms_{Life} = N/A$$

Calculation Parameters

Table 2-125 Calculation Parameters

Variable	Description	Value	Units	Ref
ΔkWh	Annual electric energy savings	Lookup in Table 2-126	kWh/yr	[185]
ΔkW_{Peak}	Peak Demand Savings	Lookup in Table 2-126	kW	[185]
ΔkW_{Life}	Lifetime electric energy savings	Calculated	kWh	

Table 2-126 Office Equipment Energy and Demand Savings Values per Unit

Measure	Energy Savings (kWh)	Demand Savings (kW)	Source
Computer (Desktop)	119	0.0161	1
Computer (Laptop)	22	0.0030	1
Printer (laser, monochrome)	≤ 5 images/min	37	1
	5 < images/min ≤ 15	26	
	15 < images/min ≤ 20	24	
	20 < images/min ≤ 30	42	
	30 < images/min ≤ 40	50	
	40 < images/min ≤ 65	181	
	65 < images/min ≤ 82	372	
	82 < images/min ≤ 90	542	
> 90 images/min	686	0.0926	
Printer (Ink Jet)	6	0.0008	1
Multifunction Device (laser, monochrome)	≤ 5 images/min	57	1
	5 < images/min ≤ 10	48	
	10 < images/min ≤ 26	52	
	26 < images/min ≤ 30	93	
	30 < images/min ≤ 50	248	

Measure		Energy Savings (kWh)	Demand Savings (kW)	Source
	50 < images/min ≤ 68	420	0.0567	
	68 < images/min ≤ 80	597	0.0806	
	> 80 images/min	764	0.1031	
Multifunction Device (Ink Jet)		6	0.0008	1
Monitor		24	0.0032	1

Peak Factors

Peak savings are incorporated in the demand savings values above.

Measure Life

The measure life for residential office equipment is 5 years [187].

References

[185] ENERGY STAR Office Equipment Calculator. Per PA TRM: “Using a commercial office equipment load shape, the percentage of total savings that occur during the PJM peak demand period was calculated and multiplied by the energy savings. As of December 1, 2018, the published ENERGY STAR Office Equipment Calculator does not reflect the current specification for computers (ENERGY STAR® Program Requirements Product Specification for Computers Eligibility Criteria Version 8.0). As a result, the savings values for computers presented in this measure entry reflect savings for V6-compliant models. This characterization should be updated when an updated ENERGY STAR Office Equipment Calculator becomes available.”

[186] [ENERGY STAR Computers Final Version 8.0 Specification Rev. July 2022](#)

[187] Residential desktop measure life. California Public Utilities Commission EUL Table, version 027 (updated November 12, 2022). Accessed December 30, 2022. <https://www.caetrm.com/shared-data/value-table/EUL/>

2.5.2 TELEVISIONS

Market	Residential
Baseline Type	TOS
Baseline	Code
End Use Subcategory	Electronics
Measure Last Reviewed	December 2022

Description

This measure relates to the upstream promotion of televisions meeting the ENERGY STAR “Most Efficient Television” Eligibility Criteria.

Baseline Case

The baseline condition is assumed to be a television meeting the Energy Star 8.0 efficiency standard and used in a residential setting.

Efficient Case

The efficient condition is an ENERGY STAR television meeting the EPA Most Efficient TV criteria and used in a residential setting.

Annual Energy Savings Algorithm

Annual Electric Energy Savings

$$\Delta kWh = kWh_b - kWh_q$$

Annual Fuel Savings

$$\Delta Therms = N/A$$

Peak Demand Savings

$$\Delta kW_{Peak} = (kW_b - kW_q) \times CF$$

Daily Peak Fuel Savings

$$\Delta Therms_{Peak} = N/A$$

Lifetime Energy Savings Algorithms

Lifetime Electric Energy Savings

$$\Delta kWh_{Life} = \Delta kWh \times EUL$$

Lifetime Fuel Savings

$$\Delta Therms_{Life} = N/A$$

Calculation Parameters

Table 2-127 Calculation Parameters

Variable	Description	Value	Units	Ref
ΔkWh	Annual electric energy savings	Calculated	kWh/yr	
ΔkW_{Peak}	Peak Demand Savings	Calculated	kW	
ΔkWh_{Life}	Lifetime electric energy savings	Calculated	kWh	
kWh_b	Annual electric energy savings for baseline case	Look up in Table 2-128	kWh/yr	[188][189]
kWh_q	Peak Demand Savings for efficient case	Look up in Table 2-128	kWh/yr	[188][190]
kW_b	Peak Demand Savings for baseline case	Look up in Table 2-129	kW	[188][189]
kW_q	Annual electric energy savings for efficient case	Look up in Table 2-129	kW	[188][190]
CF	Coincidence factor	Look up in Table 2-130	N/A	
PDF	Gas peak demand factor	Look up in Table 2-130	N/A	
EUL	Effective useful life of new unit	See Measure Life Section	Years	

Table 2-128 Conventional and ENERGY STAR kWh

Diagonal screen size	Conventional kWh _b	ENERGY STAR kWh _q
20	35.3	30.9
22	37.8	32.6
26	44.5	37.2
32	54.1	44.0
37	64.1	51.1
42	75.2	59.0
47	86.9	67.6
52	98.9	76.7
57	110.7	85.9

Diagonal screen size	Conventional kWhb	ENERGY STAR kWhq
62	121.9	95.1
65	128.2	100.4

Table 2-129 Conventional and ENERGY STAR kW

Diagonal screen size	Conventional kWb	ENERGY STAR kWq
20	0.018	0.016
22	0.020	0.017
26	0.024	0.020
32	0.029	0.023
37	0.034	0.027
42	0.040	0.032
47	0.047	0.036
52	0.053	0.041
57	0.060	0.046
62	0.066	0.051
65	0.069	0.054

Peak Factors

Table 2-130 Peak Factors

Peak Factor	Value	Ref
Electric coincidence factor (CF) ³⁷	0.21	
Natural gas peak day factor (PDF)	N/A	

Measure Life

The estimated useful life (EUL) is 6 years. [188]

References

- [188] "Consumer_Electronics_Calculator". October 2016. Energystar.gov. Accessed December 9, 2022. https://www.energystar.gov/sites/default/uploads/buildings/old/files/Consumer_Electronics_Calculator.xlsx.
- [189] ENERGY STAR® Program Requirements for Televisions Eligibility Criteria Version 8.0 <https://www.energystar.gov/sites/default/files/Final%20V8.0%20TVs%20Program%20Requirements.pdf>

³⁷ The coincidence value is an estimate based on the on-mode hours per day (5 hours/day) as a percentage of all hours.

[190] ENERGY STAR® Most Efficient 2020 Recognition Criteria Televisions
<https://www.energystar.gov/sites/default/files/Televisions%20ENERGY%20STAR%20Most%20Efficient%202020%20Final%20Criteria.pdf>

2.5.3 SMART STRIP

Market	Residential/Multi-Family/Low INcome
Baseline Condition	RF/DI/TOS
Baseline	Existing/Dual
End Use Subcategory	Control
Measure Last Reviewed	December 2022

Description

Advanced Power Strips (APS) are surge protectors that contain a number of power-saver sockets. There are two types of APS: Tier 1 and Tier 2.

Tier 1 APS have a master control socket arrangement and will shut off the items plugged into the controlled power-saver sockets when they sense that the appliance plugged into the master socket has been turned off. Conversely, the appliance plugged into the master control socket has to be turned on and left on for the devices plugged into the power-saver sockets to function.

Tier 2 APS deliver additional functionality beyond that of a Tier 1 unit, as Tier 2 units manage both standby and active power consumption. The Tier 2 APS manage standby power consumption by turning off devices from a control event; this could be a TV or other item powering off, which then powers off the controlled outlets to save energy. Active power consumption is managed by the Tier 2 unit by monitoring a user's engagement or presence in a room by either or both infrared remote signals sensing or motion sensing. After a period of user absence or inactivity, The Tier 2 unit will shut off all items plugged into the controlled outlets, thus saving energy. There are two types of Tier 2 APS available on the market. Tier 2 Infrared (IR) detect signals sent by remote controls to identify activity, while Tier 2 Infrared-Occupancy Sensing (IR-OS) use remote signals as well as an occupancy sensing component to detect activity and sense for times to shut down. Due to uncertainty surrounding the differences in savings for each technology, the Tier 2 savings are blended into a single number.

Baseline Case

The assumed baseline is a standard power strip that does not control any of the connected loads.

Efficient Case

The efficient case is the use of a Tier 1 or Tier 2 Advanced Power Strip.

Annual Energy Savings Algorithm

Annual Electric Energy Savings

$$\Delta kWh = Usage \times ERP \times ISR$$

Annual Fuel Savings

$$\Delta Therms = N/A$$

Peak Demand Savings

$$\Delta kW_{Peak} = Load \times ERP_{Peak} \times ISR$$

Daily Peak Fuel Savings

$$\Delta Therms_{Peak} = N/A$$

Lifetime Energy Savings Algorithms:

Lifetime Electric Energy Savings

$$\Delta kWh_{Life} = \Delta kWh \times EUL$$

Lifetime Fuel Savings

$$\Delta Therms_{Life} = N/A$$

Dual:

Lifetime Electric Energy Savings

$$\Delta kWh_{Life} = \Delta kWh_{EREP} \times RUL + \Delta kWh_{NR} \times EUL$$

Lifetime Fuel Savings

$$\Delta Therms_{Life} = N/A$$

Calculation Parameters

Table 2-131 Calculation Parameters

Variable	Description	Value	Units	Ref
ΔkWh	Annual electric energy savings	Calculated	kWh/yr	
$\Delta Therms$	Annual fuel savings	N/A	Therms/yr	
ΔkW_{Peak}	Peak Demand Savings	Calculated	kW	
$\Delta Therms_{Peak}$	Daily peak fuel savings	N/A	Therms/day	
ΔkWh_{Life}	Lifetime electric energy savings	Calculated	kWh	
Usage	Annual usage of system connected to power strip	Lookup in Table 2-132	kWh	[191]
ERP	Energy reduction percentage	Lookup in Table 2-132	N/A	[191]
ISR	In-service rate	Link to ISR appenix	N/A	[191]

Variable	Description	Value	Units	Ref
Load	Demand of system connected to power strip	Lookup in Table 2-132	kW	[191]
ERP _{Peak}	Energy reduction percentage during peak period	Lookup in Table 2-132	N/A	[191]
CF	Electric coincidence factor	Look up in Table 2-133	N/A	
PDF	Gas peak demand factor	Look up in Table 2-133	N/A	
EUL	Effective useful life	See Measure Life Section	Years	

Table 2-132 Impact Factors for Advanced Power Strip Types

Strip Type	End-Use	ERP	ERP _{Peak}	ISR	Usage (kWh)	Load (kW)
Tier 1	Home Entertainment Center	0.27	0.20	0.86	471	0.058
Tier 1	Home Office	0.21	0.18	0.86	399	0.044
Tier 1	Unspecified	0.25	0.19	0.86	449	0.052
Tier 2	Home Entertainment Center	0.44	0.41	0.74	471	0.058

Peak Factors

Peak demand savings are accounted for in the percent reduction factors presented above.

Table 2-133 Peak Factors

Peak Factor	Value	Ref
Electric coincidence factor (CF)	N/A	
Natural gas peak day factor (PDF)	N/A	

Measure Life

The remaining useful life (RUL) for existing equipment is limited to 1/3 of the effective useful life (EUL) of the equipment.

Table 2-134 Measure Life

Equipment	EUL	RUL	Ref
Smart Strip	5	1.67	[192]

References

- [191] RLPNC 17-3: Advanced Power Strip Metering Study,” Massachusetts Programs Administrators and EEAC, (Mar. 2019), [http://ma-eeac.org/wordpress/wp-content/uploads/RLPNC_173_APSMeteringReport_Revised_18March2019 .pdf](http://ma-eeac.org/wordpress/wp-content/uploads/RLPNC_173_APSMeteringReport_Revised_18March2019.pdf)
- [192] California Public Utilities Commission Database for Energy Efficient Resources (DEER) EUL Support Table for 2020, <http://www.deeresources.com/files/DEER2020/download/SupportTable-EUL2020.xlsx>. Accessed December 2018.

2.5.4 SOUNDBAR

Market	Residential/Multi-Family/Low Income
Baseline Type	TOS
Baseline	Code
End Use Subcategory	Soundbar
Measure Last Reviewed	December 2022

Description

This measure covers soundbars in residential applications meeting the minimum qualifying efficiency standards established under the ENERGY STAR® program, Program Requirements for Audio/Video Version 3.0, effective December 2014. A soundbar is a mains-connected product that offers audio amplification housed in a wide horizontal enclosure. ENERGY STAR® rated soundbars have a lower power draw when in sleep and idle modes and a higher amplifier efficiency than conventional models. Qualified soundbars use about 70% less energy than unqualified equipment.

Baseline Case

The baseline condition is a non-ENERGY STAR® qualified soundbar in a residential application.

Efficient Case

The compliance condition is an ENERGY STAR® qualified soundbar in a residential application with power performance specifications meeting or exceeding the requirements of ENERGY STAR® Program Requirements for Audio/Video Version 3.0, effective December 2014.

Annual Energy Savings Algorithm

Annual Electric Energy Savings

$$\Delta kWh = units \times (kWh_b - kWh_q)$$

Annual Fuel Savings

$$\Delta Therms = N/A$$

Peak Demand Savings

$$\Delta kW_{Peak} = \frac{\Delta kWh}{8,760} \times CF$$

Daily Peak Fuel Savings

$$\Delta Therms_{Peak} = N/A$$

Lifetime Energy Savings Algorithms:

Lifetime Electric Energy Savings

$$\Delta kWh_{Life} = \Delta kWh \times EUL$$

Lifetime Fuel Savings

$$\Delta Therms_{Life} = N/A$$

Calculation Parameters

Table 2-135 Calculation Parameters

Variable	Description	Value	Units	Ref
ΔkWh	Annual electric energy savings	Calculated	kWh/yr	
ΔkW_{Peak}	Peak Demand Savings	Calculated	kW	
ΔkWh_{Life}	Lifetime electric energy savings	Calculated	kWh	
Units	Number of measures installed during program	Site-specific	N/A	
kWh_b	Energy consumption for baseline case	77	kWh/yr	[193]
kWh_q	Efficient unit energy consumption	29	kWh/yr	[194]
8,760	Hours in 1 year	8,760	Hours/yr	
CF	Electric coincidence factor	Look up in Table 2-136	N/A	[195]
PDF	Gas peak demand factor	Look up in Table 2-136	N/A	
EUL	Effective useful life	See Measure Life Section	Years	[196]

Peak Factors

Table 2-136 Peak Factors

Peak Factor	Value	Ref
Electric coincidence factor (CF)	0.8	[195]
Natural gas peak day factor (PDF)	N/A	

Measure Life

The effective useful life (EUL) is 7 years. [196]

References

- [193] Based on statement that Energy Star Soundbars are 70% more efficient than standard model. *A Detailed Look at Sound Bars* Robert Huang and Daniel Lawlor, The Cadmus Group LLC, 2017.

https://www.energystar.gov/sites/default/files/asset/document/A%20Detailed%20Look%20at%20Sound%20Bars%20_FINAL.pdf https://www.energystar.gov/partner_resources/energy_star_retail_products_platform

[194] Retail Products Platform: Product Analysis, Last updated May 25, 2016 – ENERGY STAR® + 15% annual consumption increased by 15% to reflect minimum compliance with ENERGY STAR® Specification V3.0

[195] Per NY TRM: "No source specified – update pending availability and review of applicable references."

[196] EPA, Consumer Messaging Guide for Energy Star Certified Consumer Electronics. December 2016.

https://www.energystar.gov/sites/default/files/asset/document/CE_Consumer_Messaging.pdf

2.5.5 ELECTRIC VEHICLE CHARGERS

Market	Residential
Baseline Condition	TOS
Baseline	ISP
End Use Subcategory	N/A
Measure Last Reviewed	January 2023

Description

The measure is for the purchase of a Level 2 electric vehicle charger consistent with the ENERGY STAR V1.1 specification for Electric Vehicle Supply Equipment (EVSE) installed for residential household use. Networked chargers enable access to online energy management tools through an EVSE network. Non-networked chargers are standalone units that are not connected to other units through an EVSE network.

This measure was developed to be applicable to the following program types: TOS. If applied to other program types, the measure savings should be verified.

Baseline Case

A non-ENERGY STAR V1.1 networked or non-networked Level 2 electric vehicle charger.

Efficient Case

An ENERGY STAR qualified networked or non-networked Level 2 electric vehicle charger [197].

Annual Energy Savings Algorithms

Annual Electric Energy Savings

$$\Delta kWh = ((Hrs_{PS} + Hrs_{US}) \times W_b - (Hrs_{PS} \times W_{q,p} \times Hrs_{US} \times W_{q,u}))/1,000$$

Where,

$$Hrs_{ps} = Hours_p - Hours_c$$

Annual Fuel Savings

$$\Delta Therms = N/A$$

Peak Demand Savings

$$\Delta kW_{Peak} = Avg_{kW} \times CF$$

Daily Peak Fuel Savings

$$\Delta Therms_{Peak} = N/A$$

Lifetime Energy Savings Algorithms

Lifetime Electric Energy Savings

$$\Delta kWh_{Life} = \Delta kWh \times EUL$$

Lifetime Fuel Savings

$$\Delta Therms_{Life} = N/A$$

Calculation Parameters

Table 2-137 Calculation Parameters

Variable	Description	Value	Units	Ref
ΔkWh	Annual electric energy savings	Calculated	kWh/yr	
ΔkW_{Peak}	Peak Demand Savings	Calculated	kW	
ΔkWh_{Life}	Lifetime electric energy savings	Calculated	kWh	
Hrs_{ps}	Annual standby hours plugged in	Calculated	Hours	
Hrs_c	Annual active charging hours	Site-specific, if unknown assume 278	Hours	[201]
Hrs_p	Total annual hours plugged in	Site-specific, if unknown assume 3,511	Hours	[201]
Hrs_{us}	Annual standby hours unplugged	Site-specific, if unknown assume 5,249	Hours	[201]
W_b	Baselines average standby power	Lookup in Table 2-138	W	[198][199]
$W_{q,p}$	Efficient average standby power with vehicle plugged in	Lookup in Table 2-138	W	[200]
$W_{q,u}$	Efficient average standby power in no vehicle mode	Lookup in Table 2-138	W	[200]
Avg_{kW}	Average electric demand during standby	Lookup in Table 2-138	kW	
CF	Electric coincidence factor	Lookup in Table 2-139	N/A	
PDF	Gas peak day factor	Lookup in Table 2-139	N/A	
EUL	Effective useful life	See Measure Life Section	Years	

Table 2-138 Standby Power

Network Type	W_b	$W_{q,p}$	$W_{q,u}$	kW
Non-Networked ³⁸	3.7	3.5	2.1	0.00107
Networked ³⁸	9.9	3.2	2.5	0.00713

Peak Factors**Table 2-139 Peak Factors**

Peak Factor	Value	Ref
Electric coincidence factor (CF)	1	
Natural gas peak day factor (PDF)	N/A	

Measure Life

The effective useful life (EUL) is 10 years [197].

References

- [197] Energy Star Spec v1.1 effective from 3/31/2021.
https://www.energystar.gov/sites/default/files/ENERGY%20STAR%20V1.1%20DC%20EVSE%20Final%20Specification_0.pdf
- [198] Based on Northwest Power and Conservation Council, Regional Technical Forum updated workbook for Level 2 Electric Vehicle Charger version 3.0 <https://nwcouncil.app.box.com/v/Lvl2EVChgrsv3-0>
- [199] INL charger testing <https://avt.inl.gov/evse-type/ac-level-2.html>
- [200] “ENERGY STAR Market and Industry Scoping Report: Electric Vehicle Supply Equipment ENERGY STAR Market and Industry Scoping Report Electric Vehicle Supply Equipment (EVSE)” 2013 (source data is from INL).
https://www.energystar.gov/sites/default/files/asset/document/electric_vehicle_scoping_report.pdf
- [201] 2021 ENERGY STAR QPL of Residential EVSE. Averaged Partial On Mode Input Power (W) and Idle Mode Input Power (W). See Northwest Power and Conservation Council, Regional Technical Forum updated workbook for Level 2 Electric Vehicle Charger version 3.0 <https://nwcouncil.app.box.com/v/Lvl2EVChgrsv3-0>

³⁸ kW for non-networked and networked type = $((W_b - W_{q,p}) * Hrs_{ps}/8482) + ((W_b - W_{q,u}) * Hrs_{us}/8482))/1000$

2.6 SHELL

2.6.1 RESIDENTIAL/LOW-RISE MULTIFAMILY AIR SEALING

Market	Residential/Low-rise Multifamily
Baseline Condition	RF
Baseline	Existing
End Use Subcategory	Shell
Measure Last Reviewed	January 2023

Description

This section provides energy savings algorithms for the sealing air leakage paths to reduce the natural air infiltration rate through the installation of products and repairs to the building envelope. It is assumed that air sealing is the first priority among candidate space conditioning measures. Expected percentage savings is based on previous experiences with measured savings from similar programs.

Methods are provided below for single-family, low-rise multifamily and high-rise multifamily applications with and without blower door testing conducted before and after implementation of air sealing treatments. A blower door test is performed to measure the leakage rate by depressurizing the building to a standard pressure difference of 50 Pascals or 0.2 inches of water.

Blower door tests shall be performed whenever possible. This method provided below for single family/low-rise multifamily without blower door testing should only be used if blower door testing is not feasible due to health or safety concerns, e.g. the presence of a hazardous material like asbestos or mold, ongoing construction in the home or concerns regarding COVID-19.

Baseline Case

The baseline case is a building envelope with natural air infiltration through air leakage paths.

Efficient Case

The exterior envelope, as well as interior walls/partitions between conditioned and unconditioned spaces should be inspected and all gaps sealed. At a minimum, the following items shall be inspected, and sealing measures may be implemented based upon inspection results:

- Caulk and weather strip doors and windows that leak air
- Repair or replace doors leading from conditioned to unconditioned space
- Seal air leaks between unconditioned (including unconditioned basement and attics) and conditioned spaces to include, but not limited to, plumbing, ducting, electrical wiring, wall top plates, chimneys, flues, and dropped soffits

- Use foam sealant on larger gaps around windows, baseboards, and other places where air leakage, either infiltration or exfiltration may occur

Annual Energy Savings Algorithms

Annual Electric Energy Savings

$$\Delta kWh = \left(\frac{\Delta CFM_{50}}{F_n \times F_h} \right) \times \left(\frac{\Delta kWh}{CFM} \right)$$

Annual Fuel Savings

$$\Delta Therms = \left(\frac{\Delta CFM_{50}}{F_n \times F_h} \right) \times \left(\frac{\Delta therms}{CFM} \right)$$

Peak Demand Savings

$$\Delta kW_{Peak} = \left(\frac{\Delta CFM_{50}}{F_n \times F_h} \right) \times \left(\frac{\Delta kW}{CFM} \right) \times CF$$

Daily Peak Fuel Savings

$$\Delta Therms_{Peak} = \Delta Therms \times PDF$$

Lifetime Energy Savings Algorithms

Lifetime Electric Energy Savings

$$\Delta kWh_{Life} = \Delta kWh \times EUL$$

Lifetime Fuel Savings

$$\Delta Therms_{Life} = \Delta Therms \times EUL$$

Calculation Parameters

Table 2-140 Calculation Parameters

Variable	Description	Value	Units	Ref
ΔkWh	Annual electric energy savings	Calculated	kWh/yr	
$\Delta Therms$	Annual fuel savings	Calculated	Therms/yr	
ΔkW_{Peak}	Peak Demand Savings	Calculated	kW	
$\Delta Therms_{Peak}$	Daily peak fuel savings	Calculated	Therms/day	
ΔkWh_{Life}	Lifetime electric energy savings	Calculated	kWh	
$\Delta Therms_{Life}$	Lifetime fuel savings	Calculated	Therms	

Variable	Description	Value	Units	Ref
ΔCFM_{50}	Reduction in air leakage from blower door tests at 50 Pascals pressure difference	Site-specific, if unknown calculated ³⁹	CFM	
F_n	Infiltration-Leakage Ratio, used to convert pressurized blower door testing results to natural infiltration rates, climate zone factor	19	N/A	[202]
F_h	Infiltration-Leakage Ratio, used to convert pressurized blower door testing results to natural infiltration rates, building height factor	Look up in Table 2-141	N/A	[202]
$\Delta\text{kWh}/\text{CFM}$	Annual electric energy savings per cubic foot per minute of reduced air leakage at 50 Pa	Look up in Table 2-142 or Table 2-143	kWh/CFM	[203]
$\Delta\text{kW}/\text{CFM}$	Peak coincident demand electric savings per cubic foot per minute of reduced air leakage at 50 Pa	Look up in Table 2-142 or Table 2-143	kW/CFM	[203]
$\Delta\text{therms}/\text{CFM}$	Annual fossil fuel energy savings per cubic foot per minute of reduced air leakage at 50 Pa	Look up in Table 2-142 or Table 2-143	therms/CFM	[203]
CF	Coincidence factor	Look up in Table 2-144	N/A	
PDF	Gas peak day factor	Look up in Table 2-144	N/A	
EUL	Effective useful life	See Measure Life Section	Years	

Table 2-141 Infiltration-Leakage Ratio, building height factor

Number of conditioned stories	F_h
1 story	1.00
1.5 stories	0.90
2 stories	0.81
2.5 stories	0.76
3 + stories	0.70

Table 2-142 Impact per CFM for Single-family Residential Infiltration Reduction

	$\Delta\text{kWh}/\text{CFM}$	$\Delta\text{kW}/\text{CFM}$	$\Delta\text{therms}/\text{CFM}$
AC Fuel Heat	2.3	0.004	1.7
Heat Pump	21.0	0.003	N/A
AC Electric Heat	39.8	0.004	N/A
Fuel Heat Only	0.8	0.000	1.7

³⁹ For single-family and low-rise multifamily homes, if conducting a blower door test is not feasible due to health and safety concerns, multiply affected area square footage by a deemed $\Delta\text{CFM}_{50}/\text{SF}$ of 0.50 (i.e., $\Delta\text{CFM}_{50} = 0.50 \times \text{SF}$). Default $\Delta\text{CFM}_{50}/\text{SF}$ of 0.50 is the median value of single-family blower door test data provided by ConEdison, conducted 2018-2020.

	$\Delta kWh/CFM$	$\Delta kW/CFM$	$\Delta therms/CFM$
Electric heat Only	38.4	0.000	N/A

Table 2-143 Impact per CFM for Multi-Family Low-rise Infiltration Reduction

	$\Delta kWh/CFM$	$\Delta kW/CFM$	$\Delta therms/CFM$
AC Fuel Heat	1.5	0.003	1.9
Heat Pump	21.2	0.003	N/A
AC Electric Heat	29.6	0.003	N/A
Fuel Heat Only	1.1	0.000	1.9
Electric heat Only	29.2	0.000	N/A

Peak Factors

Table 2-144 Peak Factors

Peak Factor	Value	Ref
Coincidence factor	0.69	[204]
Natural gas peak day factor (PDF)	See Appendix G: Natural Gas Peak Day Factors	

Measure Life

The effective useful life (EUL) is 15 years [205].

References

- [202] Lawrence Berkeley Laboratory, Estimation of Infiltration from Leakage and Climate Indicators, Sherman, M., December 1986, http://eta-publications.lbl.gov/sites/default/files/estimation_of_infiltration_from_leakage_and_climate_indicators.pdf
- [203] New York State Joint Utilities, New York Standard Approach for Estimating Energy Savings from Energy Efficiency Programs, V10, January 2023.
- [204] Based on BG&E 'Development of Residential Load Profile for Central Air Conditioners and Heat Pumps' research, the Maryland Peak Definition coincidence factor is 0.69. This study is not publicly available, but is referenced by M. M. Straub, Using Available Information for Efficient Evaluation of Demand-Side Management Programs, Electricity Journal, September 2011 and supported by research conducted by Cadmus on behalf of the RM Management Committee.
- [205] GDS Associates, Inc. Measure Life Report, Residential and Commercial/Industrial Lighting and HVAC Measures. 2007. https://library.cee1.org/sites/default/files/library/8842/CEE_Eval_MeasureLifeStudyLights&HVACGDS_1Jun2007.pdf

2.6.2 INSULATION

Market	Residential/Multifamily
Baseline Condition	RF
Baseline	Existing
End Use Subcategory	Shell
Measure Last Reviewed	January 2023

Description

This measure applies to the installation of insulation to the attic floor, roof assembly, walls, and floors to reduce the thermal conductance of the building envelope. Energy and demand savings are realized through reductions in the building's heating and cooling loads. Existing (baseline) and installed (qualifying) shell R-values must be captured to estimate energy savings.

This measure is only applicable as a retrofit in existing single and multi-family buildings, excluding gut rehab/major renovation projects. These projects entail whole-building envelope alterations that trigger more stringent code provisions, limiting potential incremental savings.

For applications involving insulation on more than one component, evaluate each component separately via the method below and sum together to determine total estimated energy savings. If the age of the baseline equipment cannot be determined, assume two-third of the EUL has lapsed.

Baseline Case

The existing condition is a residential building envelope with insufficient insulation.

Efficient Case

The efficient condition is a residential building envelope with increased insulation meeting or exceeding applicable construction code requirements.

Annual Energy Savings Algorithms

Annual Electric Energy Savings

$$\Delta kWh = \Delta kWh_{cooling} + \Delta kWh_{heating}$$

Savings from reduction in Air Conditioning Load:

$$\Delta kWh_{cooling} = \frac{\left(\frac{1}{R_b} - \frac{1}{R_q}\right) \times CDD \times 24 \times Area \times (1 - F_{framing})}{1,000 \times SEER}$$

Savings for homes with electric heat (Heat Pump or resistance):

$$\Delta kWh_{heating} = \frac{\left(\frac{1}{R_b} - \frac{1}{R_q}\right) \times HDD \times 24 \times Area \times (1 - F_{framing})}{1,000 \times HSPF}$$

Annual Fuel Savings

$$\Delta Therms = \frac{\left(\frac{1}{R_b} - \frac{1}{R_q}\right) \times HDD \times 24 \times Area \times (1 - F_{framing})}{Fuel\ Btu \times AFUE}$$

Peak Demand Savings

$$\Delta kW_{Peak} = \frac{\left(\frac{1}{R_b} - \frac{1}{R_q}\right) \times Area \times (1 - F_{framing})}{1,000 \times EER} \times CF$$

Daily Peak Fuel Savings

$$\Delta Therms_{Peak} = \Delta Therms \times PDF$$

Lifetime Energy Savings Algorithms

Lifetime Electric Energy Savings

$$\Delta kWh_{Life} = \Delta kWh \times EUL$$

Lifetime Fuel Savings

$$\Delta Therms_{Life} = \Delta Therms \times EUL$$

Calculation Parameters

Table 2-145 Calculation Parameters

Variable	Description	Value	Units	Ref
ΔkWh	Annual electric energy savings	Calculated	kWh/yr	
$\Delta Therms$	Annual fuel savings	Calculated	Therms/yr	
ΔkW_{Peak}	Peak Demand Savings	Calculated	kW	
$\Delta Therms_{Peak}$	Daily peak fuel savings	Calculated	Therms/day	
ΔkWh_{Life}	Lifetime electric energy savings	Calculated	kWh	
$\Delta Therms_{Life}$	Lifetime fuel savings	Calculated	Therms	
$\Delta kWh_{cooling}$	Annual electric cooling energy savings	Calculated	kWh/yr	
$\Delta kWh_{heating}$	Annual electric heating energy savings	Calculated	kWh/yr	
R_b	R-value of existing insulation	Site-specific, if unknown look up in Table 2-147	h.ft ² .°F/Btu	
R_q	R-value of new insulation	Site-specific	h.ft ² .°F/Btu	

Variable	Description	Value	Units	Ref
CDD	Cooling degree days: number of degrees the average daily temperature is above 65°F	Look up in Table 2-148	°F-day/yr	[206]
Area	Area of insulated surface	Site-specific	ft ²	
F _{framing}	Framing factor	Look up in Table 2-146	N/A	[208]
1,000	Conversion Factor from W to kW	N/A	W/kW	
SEER/SEER2	Efficiency in SEER of Air Conditioning equipment	Site specific, if unknown look up in Table 2-149	Btu/watt-hr	[209]
EER/EER2	Efficiency in EER of Air Conditioning equipment	Site-specific. If unknown, see Appendix E: Code-Compliant Efficiencies	Btu/watt-hr	[209]
HDD	Heating degree days: number of degrees the average daily temperature is below 65°F	Look up in Table 2-148	°F-day/yr	[206]
HSPF/HSPF2	Heating Seasonal Performance Factor	Site specific, if unknown look up in Table 2-150	Btu/watt-hr	[209]
Fuel Btu	Conversion Factor to Therms	Look up in Table 2-153		
AFUE	Annual Fuel Utilization Efficiency – Boilers & Furnaces	Site-specific, if unknown look up in Table 2-151, Table 2-152	N/A	[209]
AFUE	Annual Fuel Utilization Efficiency – Electric Resistance Heating	35%	N/A	[210]
CF	Electric coincidence factor	Look up in Table 2-154	N/A	
PDF	Gas peak day factor	Look up in Table 2-154	N/A	
EUL	Effective useful life	See Measure Life Section	Years	

Table 2-146 Framing Factor

Insulation Location	Value	Ref
Framing factor - Ceiling	7%	[208]
Framing factor - Wall	25%	[208]
Framing factor - Floor	12%	[208]

Table 2-147 Existing Insulation R-Value (R_b)

Building Envelope Component	Value
Fiberglass - Batt	3.14
Fiberglass – Blown Attic	2.2

Building Envelope Component	Value
Fiberglass – Blown Wall	3.2
Rock Wool - Batt	3.14
Rock Wool – Blown Attic	3.1
Rock Wool – Blown Wall	3.03
Cellulose – Blown Attic	3.13
Cellulose – Blown Wall	3.7
Vermiculite	2.13
Air-entrained Concrete	3.9
Urea Terpolymer Foam	4.48
Rigid Fiberglass (> 4 lb/ft ³)	4
Expanded Polystyrene (Beadboard)	4
Extruded Polystyrene	5
Polyurethane (Foamed-in-place)	6.25
Polyisocyanurate (Foil-face)	7.2

Table 2-148 Heating and Cooling Degree Days (65°F set point)

City	HDD	CDD
North	5,734	778
Coastal	4,614	1,056
Central	5,051	1,073
Pine barrens	4,891	1,067
Southwest	5,028	1,046

Table 2-149 Cooling Equipment SEER

Cooling Equipment	SEER	SEER2
Split System (A/C)	13	13.4
Split System (HP)	14	14.3
Single Package (A/C)	14	13.4
Single Package (HP)	14	13.4

Table 2-150 Cooling Equipment HSPF

Cooling Equipment	HSPF	HSPF2
Split System (HP)	8.2	7.5
Single Package (HP)	8.0	6.7

Table 2-151 AFUE of Residential Boilers

Product Class	AFUE (Manufactured before Sep 1, 2012)	AFUE (Manufactured on and after Sep 1, 2012 and before Jan 15, 2021)	AFUE (Manufactured on and after January 15, 2021)
Gas-fired hot water boiler	0.80	0.82	0.84
Gas-fired steam boiler	0.75	0.80	0.82
Oil-fired hot water boiler	0.80	0.84	0.86
Oil-fired steam boiler	0.80	0.82	0.85

Table 2-152 AFUE of Residential Furnaces

Product Class	AFUE	Compliance Date	AFUE (Manufactured before compliance Date)
Non-weatherized gas furnaces (not including mobile home furnaces)	0.80	November 19, 2015.	0.78
Mobile Home gas furnaces	0.80	November 19, 2015.	0.75
Non-weatherized oil-fired furnaces (not including mobile home furnaces)	0.83	May 1, 2013.	0.78
Mobile Home oil-fired furnaces	0.75	September 1, 1990.	0.75
Weatherized gas furnaces	0.81	January 1, 2015.	0.78
Weatherized oil-fired furnaces	0.78	January 1, 1992.	0.78

Table 2-153 BTU Conversion Factors

Conversion Factor	Value	Units
Natural Gas - BTU to Therms	100,000	Btu/Therms
Heating Oil - BTU to Gallons to Therms	138,000 x 0.916	Btu/Therms
Propane - BTU to Gallons Therms	92,000 x 1.4	Btu/Therms

Peak Factors

Table 2-154 Peak Factors

Peak Factor	Value	Ref
Electric coincidence factor (CF)	0.69	[207]
Natural gas peak day factor (PDF)	See Appendix G: Natural Gas Peak Day Factors	

Measure Life

The effective useful life (EUL) is 25 years [211].

References

- [206] ONJSC: Monthly/Annual Temperature Normals (1991-2020).
http://climate.rutgers.edu/stateclim_v1/norms/monthly/index.html.
- [207] BG&E: Development of Residential Load Profile for Central Air Conditioners and Heat Pumps, as reported in NEEP, Mid-Atlantic Technical Reference Manual, V8. 2018, p. 260
- [208] ASHRAE, 2001, “Characterization of Framing Factors for New Low-Rise Residential Building Envelopes (904-RP),” Table 7.1.
- [209] Code of Federal Regulations. 2022. Review of Title 10, Chapter II, Subchapter D, Part 430 eCFR. December 1, 2022.
<https://www.ecfr.gov/current/title-10/chapter-II/subchapter-D/part-430>
- [210] Electric resistance heating calculated by determining overall fuel cycle efficiency by dividing the average PJM heat rate (9,642 btu/kWh) by the btu’s per kWh (3,413 btu/kWh), resulting in 2.83 btuin per 1 btuout.
- [211] GDS Associates, Inc., Measure Life Report: Residential and Commercial/Industrial Lighting and HVAC Measures, June 2007, Table 1 – Residential Measures.

2.7 WATER HEATING

2.7.1 HEAT PUMP WATER HEATER

Market	Residential/Multifamily
Baseline Condition	NC/TOS/DI/EREP
Baseline	Code/Dual
End Use Subcategory	Equipment
Measure Last Reviewed	January 2023

Description

Heat pump water heaters take heat from the surrounding air and transfer it to the water in the tank, unlike conventional water heaters, which use either gas (or sometimes other fuel) burners or electric resistance heating coils to heat the water. Due to the interactivity of the heat pump water heater with the building's HVAC system, there is a decrease in a home's cooling energy consumption and an increase in the heating energy consumption if the heat pump water heater is located in conditioned space.

Baseline Case

TOS/NC baseline equipment is a minimally code compliant, electric storage type water heater.⁴⁰ EREP/DI baseline equipment is a minimally code compliant system of the same type and fuel as the existing equipment.

Efficient Case

The efficient condition is an ENERGY STAR V. 5.0 qualified heat pump water heater.

Annual Energy Savings Algorithms

Annual Electric Energy Savings

$$\Delta kWh = \Delta kWh_{dhw} + \Delta kWh_{cooling} - \Delta kWh_{heating}$$

Where,

$$\Delta kWh_{dhw} = \frac{Load_{dhw}}{3,412} \times \left(\frac{F_{dhw,electric}}{UEF_b} - \frac{1}{UEF_q \times F_{derate}} \right)$$
$$\Delta kWh_{cooling} = \frac{Load_{dhw}}{1,000} \times \left(1 - \frac{1}{UEF_q} \right) \times F_{location} \times \frac{F_{cool}}{SEER}$$

⁴⁰ Note that heat pump water heaters are code required for tanks greater than 55 gallons.

$$\Delta kWh_{heating} = \frac{Load_{dhw}}{1,000} \times \left(1 - \frac{1}{UEF_q}\right) \times F_{location} \times F_{heat,electric} \times \frac{F_{heat}}{HSPF}$$

$$Load_{dhw} = GPD \times 365 \times 8.33 \times (T_{set} - T_{main})$$

$$GPD = 17.2 \times N_{ppl}$$

Annual Fuel Savings

$$\Delta Therms = \Delta Therms_{dhw} - \Delta Therms_{heating}$$

Where,

$$\Delta Therms_{dhw} = \frac{Load_{dhw}}{100000} \times \left(\frac{F_{dhw,ff}}{UEF_b} + \frac{F_{dhw,boiler}}{AFUE} \right)$$

$$\Delta Therms_{heating} = \frac{Load_{dhw}}{100000} \times \left(1 - \frac{1}{UEF_q}\right) \times F_{location} \times F_{heat,ff} \times \frac{F_{heat}}{AFUE}$$

Peak Demand Savings⁴¹

For water heaters with a rated storage volume of 55 gallons or less:

$$\Delta kW_{Peak} = 0.09 \times \frac{UEF_q}{3.41}$$

For water heaters with a rated storage volume greater than 55 gallons:

$$\Delta kW_{Peak} = 0.11 \times \frac{UEF_q}{3.34}$$

Daily Peak Fuel Savings

$$\Delta Therms_{Peak} = \Delta Therms \times PDF$$

Lifetime Energy Savings Algorithms

Lifetime Electric Energy Savings

$$\Delta kWh_{Life} = \Delta kWh \times EUL$$

Lifetime Fuel Savings

$$\Delta Therms_{Life} = \Delta Therms \times EUL$$

Dual:

⁴¹ From Mid-Atlantic TRM v10: "Analysis of special study. Cadmus, "EmPOWER Maryland Heat Pump Water Heater Baseline and Market Analysis", February 2020. The study leveraged HPWH load shapes from "Field Testing of Pre-Production Prototype Residential Heat Pump Water Heaters" (https://www.energy.gov/sites/prod/files/2014/01/f7/heat_pump_water_heater_testing.pdf)."

Lifetime Electric Energy Savings

$$\Delta kWh_{Life} = \Delta kWh_{EREP} \times RUL + \Delta kWh_{NR} \times EUL$$

Lifetime Fuel Savings

$$\Delta Therms_{Life} = \Delta Therms_{EREP} \times RUL + \Delta Therms_{NR} \times EUL$$

Calculation Parameters

Table 2-155 Calculation Parameters

Variable	Description	Value	Units	Ref
ΔkWh	Annual electric energy savings	Calculated	kWh/yr	
ΔkWh_{dhw}	Annual domestic hot water electric energy savings	Calculated	kWh/yr	
$\Delta kWh_{cooling}$	Annual cooling electric energy savings	Calculated	kWh/yr	
$\Delta kWh_{heating}$	Annual heating electric energy impacts	Calculated	kWh/yr	
$\Delta Therms$	Annual fuel savings	Calculated	Therms/yr	
$\Delta Therms_{dhw}$	Annual domestic hot water fuel savings	Calculated	Therms/yr	
$\Delta Therms_{heat}$	Annual space heating fuel impacts	Calculated	Therms/yr	
ΔkW_{Peak}	Peak Demand Savings	Calculated	kW	
$\Delta Therms_{Peak}$	Daily peak fuel savings	Calculated	Therms/day	
ΔkWh_{Life}	Lifetime electric energy savings	Calculated	kWh	
$\Delta Therms_{Life}$	Lifetime fuel savings	Calculated	Therms	
$Load_{dhw}$	Annual hot water load	Calculated	Btu	
V_t	Tank volume	Site-specific	Gal	
UEF_q	Uniform energy factor of efficient unit	Site-specific, if unknown look up in Table 2-158	N/A	[218]
AFUE	Annual fuel utilization efficiency of existing space heating or domestic hot water boiler or furnace	Site-specific, if unknown look up in Table 2-161	N/A	[215]
GPD	Gallons per day	Calculated, if N_{ppl} unknown use 46	Gal/day	[212]
N_{ppl}	Number of people in the home	Site-specific, if unknown use default GPM	persons	
$F_{DHW,electric}$	Electric water heating factor	Look up in Table 2-156	N/A	
$F_{DHW,g}$	Gas water heating factor	Look up in Table 2-156	N/A	
$F_{DHW,boiler}$	Gas boiler water heating factor	Look up in Table 2-156	N/A	
$F_{heat,electric}$	Electric space heating factor	Look up in Table 2-156	N/A	
$F_{heat,g}$	Gas space heating factor	Look up in Table 2-156	N/A	

Variable	Description	Value	Units	Ref
UEF _b	Uniform energy factor of baseline unit as a function of baseline fuel type.	Look up in Table 2-157	N/A	[215][216]
F _{derate}	Efficiency derating factor	Look up in Table 2-159	N/A	[217][218]
F _{location}	Installation location factor	Look up in Table 2-159	N/A	
SEER	Seasonal energy efficiency ratio of existing air conditioning system	Look up in Table 2-160	Btu/W·hr	
HSPF	Heating seasonal performance factor of existing electric heating system	Look up in Table 2-160	Btu/W·hr	
CF	Electric coincidence factor	Look up in Table 2-162	N/A	
PDF	Gas peak day factor	Look up in Table 2-162	N/A	
T _{set}	Water heater setpoint temperature	125	°F	[213]
T _{main}	Supply water temperature in water main	60	°F	[214]
F _{cool}	Cooling factor	0.51	N/A	[216]
F _{heat}	Heating factor	0.49	N/A	[216]
365	Days per year	365	Days/yr	
8.33	Unit conversion, Btu/gal·°F	8.33	Btu/gal·°F	
3,412	Unit conversion, Btu/kWh	3,412	Btu/kWh	
3.412	Unit conversion, Btu/W·hr	3.412	Btu/W·hr	
1000	Unit conversion, Watt/kW	1000	W/kW	
100,000	Unit conversion, Btu/therm	100,000	Btu/therm	
EUL	Effective useful life	See Measure Life Section	Years	

Table 2-156 DHW and Heating Factors

Baseline Scenario	F _{DHW,electric}	F _{DHW,g}	F _{DHW,boiler}	F _{heat,electric}	F _{heat,g}
TOS/NC: use electric baseline	1.0	0	0	1.0	0
EREP/DI with existing electric water heater and space heat	1.0	0	0	1.0	0
EREP/DI with existing gas water heater and space heat	0	1.0	1.0	0	1.0

Table 2-157 Baseline UEF

Product Class	Rated Storage Volume and Input Rating	First Hour Rating	UEF _b
Electric Storage Water Heater	≥ 20 gal and ≤ 55 gal	< 18 gallons	$0.8808 - (0.0008 \times v_t)$
		≥ 18 and < 51 gallons	$0.9254 - (0.0003 \times v_t)$
		≥ 51 and < 75 gallons	$0.9307 - (0.0002 \times v_t)$
		≥ 75 gallons	$0.9349 - (0.0001 \times v_t)$
	> 55 gal and ≤ 120 gal	< 18 gallons	$1.9236 - (0.0011 \times v_t)$
		≥ 18 and < 51 gallons	$2.0440 - (0.0011 \times v_t)$
		≥ 51 and < 75 gallons	$2.1171 - (0.0011 \times v_t)$
		≥ 75 gallons	$2.2418 - (0.0011 \times v_t)$
Gas-Fired Storage Water Heater	≥ 20 gal and ≤ 55 gal	< 18 gallons	$0.3456 - (0.0020 \times v_t)$
		≥ 18 and < 51 gallons	$0.5982 - (0.0019 \times v_t)$
		≥ 51 and < 75 gallons	$0.6483 - (0.0017 \times v_t)$
		≥ 75 gallons	$0.6920 - (0.0013 \times v_t)$
	> 55 gal and ≤ 100 gal	< 18 gallons	$0.6470 - (0.0006 \times v_t)$
		≥ 18 and < 51 gallons	$0.7689 - (0.0005 \times v_t)$
		≥ 51 and < 75 gallons	$0.7897 - (0.0004 \times v_t)$
		≥ 75 gallons	$0.8072 - (0.0003 \times v_t)$

Table 2-158 Efficient UEF

Product Class	Criteria	UEF
Electric Storage Water Heater	Integrated HPWH	3.30
	Integrated HPWH, 120 Volt/15 Amp Circuit	2.20
	Split-system HPWH	2.20

Table 2-159 Derating Factors

Area	F _{derate}	F _{location}
Unconditioned Basement	0.86	0
Garage	0.83	0
Conditioned Space	1.00	1.00

Table 2-160 SEER and HSPF Values

Type	SEER	HSPF
Air-Source Heat Pump	14.0	8.0
Ground-Source Heat Pump	15.0	10.9
CAC	14.0	N/A
Mini Split HP	15.0	8.8

Table 2-161 AFUE Values

Equipment Type	Size Range	AFUE
Warm Air Furnace, Gas Fired	All Capacities	0.80
Boiler, Hot Water, Gas Fired	All Capacities	0.82
Boiler, Steam, Gas Fired	All Capacities	0.80

Peak Factors

Peak coincidence is accounted for in the peak demand savings algorithm section above.

Table 2-162 Peak Factors

Peak Factor	Value	Ref
Electric coincidence factor (CF)	N/A	
Natural gas peak day factor (PDF)	See Appendix G: Natural Gas Peak Day Factors	

Measure Life

The remaining useful life (RUL) for existing equipment is limited to 1/3 of the effective useful life (EUL) of the equipment.

Table 2-163 Measure Life

Equipment	EUL	RUL	Ref
Heat Pump Water Heater	10	3.33	[220]

References

[212] EmPOWER heat pump water heater program participation in 2018-2019 and participant survey data; per Mid-Atlantic TRM v10, pg. 150. <https://neep.org/sites/default/files/media-files/trmv10.pdf>

[213] NMR Group, Inc., 2018 Pennsylvania Statewide Act 129 Residential Baseline Study (Feb 2018). https://www.puc.pa.gov/Electric/pdf/Act129/SWE-Phase3_Res_Baseline_Study_Rpt021219.pdf

- [214] Using Rock Spring, PA (Site 2036) as a proxy, the mean of soil temperature at 40 inch depth is 51.861. Calculated using Daily SCAN Standard - Period of Record data from April 1999 to December 2018 from the Natural Resource Conservation Service Database.
https://wcc.sc.egov.usda.gov/nwcc/rgrpt?report=daily_scan_por&state=PA. Methodology follows Missouri TRM 2017 Volume 2: Commercial and Industrial Measures. p. 78.
<https://energy.mo.gov/sites/energy/files/MOTRM2017Volume2.pdf>
- [215] 10 CFR Subpart C of Part 430, <https://www.ecfr.gov/current/title-10/chapter-II/subchapter-D/part-430/subpart-C/section-430.32>
- [216] 10 CFR Subpart B of Part 429, <https://www.ecfr.gov/current/title-10/chapter-II/subchapter-D/part-429/subpart-B/section-429.17>
- [217] Bonneville Power Administration, Residential Heat Pump Water Heater Evaluation: Lab Testing & Energy Use Estimates. (November 2011), https://rpsec.energy.gov/sites/default/files/tech-resource/attachment/BPA_HPWH_Lab_Evaluation_11-9-2011.pdf
- [218] Fluid Market Strategies, NEEA Heat Pump Water Heater Field Study Report. (2013), <https://neea.org/img/uploads/heat-pump-water-heater-field-study-report.pdf>
- [219] ENERGY STAR Program Requirements Product Specification for Residential Water Heaters, Eligibility Criteria, Version 4.0. (2021), https://www.energystar.gov/sites/default/files/asset/document/ENERGY%20STAR%20Version%204.0%20Water%20Heaters%20Final%20Specification%20and%20Partner%20Commitments_0.pdf
- [220] California Public Utilities Commission Database for Energy Efficient Resources (DEER) EUL Support Table for 2020, <http://www.deeresources.com/files/DEER2020/download/SupportTable-EUL2020.xlsx>

2.7.2 INDIRECT WATER HEATER

Market	Residential
Baseline Condition	TOS/NC/EREP
Baseline	Code/Dual
End Use Subcategory	Equipment
Measure Last Reviewed	December 2022

Description

This measure covers the installation of a fossil fuel indirect-fired storage water heating system in which the stored water is heated via hot water produced by a fossil fuel boiler rather than direct input from electric elements or fossil fuel burners. In such a system, a heat exchanger separates the potable water in the water heater from the boiler water. This measure applies to indirect-fired systems comprising a boiler with input heating capacity less than 300,000 Btu/h and a storage tank with a capacity of 20 to 120 gallons installed in residential applications.

This measure estimates savings associated with the delivery of potable hot water only and assumes the installation of zone priority controls to interrupt demand for space heating hot water until domestic hot water demand is met.

Baseline Case

The baseline condition is a minimally code-compliant indirect fired, fossil fuel storage type water heater with a recovery efficiency of 75%, tank volume equal to the energy efficient condition.

Efficient Case

The efficient case is an indirect fossil fuel-fired water heating system with efficiency meeting or exceeding 0.85 AFUE.

Annual Energy Savings Algorithm

Annual Electric Energy Savings

$$\Delta kWh = N/A$$

Annual Fuel Savings

$$\Delta Therms = units \times \left(\frac{GPD \times 365 \times 8.33 \times \Delta T_{main}}{100,000} \times \left(\frac{1}{Eff_b} - \frac{1}{Eff_q} \right) + \left(\frac{UA_b}{Eff_b} - \frac{UA_q}{Eff_q} \right) \times \frac{\Delta T_{amb} \times 8,760}{100,000} \right)$$

Where,

$$\Delta T_{main} = T_{set} - T_{main}$$

$$\Delta T_{amb} = T_{set} - T_{amb}$$

$$GPD = 17.2 \times N_{ppt}$$

$$UA_q = \frac{SL_q}{70} \times v_q \times 8.33$$

Peak Demand Savings

$$\Delta kW_{Peak} = N/A$$

Daily Peak Fuel Savings

$$\Delta Therms_{Peak} = \Delta Therms \times PDF$$

Lifetime Energy Savings Algorithms:

Lifetime Electric Energy Savings

$$\Delta kWh_{Life} = \Delta kWh \times EUL$$

Lifetime Fuel Savings

$$\Delta Therms_{Life} = \Delta Therms \times EUL$$

Dual:

Lifetime Electric Energy Savings

$$\Delta kWh_{Life} = N/A$$

Lifetime Fuel Savings

$$\Delta Therms_{Life} = \Delta Therms_{EREP} \times RUL + \Delta Therms_{NR} \times EUL$$

Calculation Parameters

Table 2-164 Calculation Parameters

Variable	Description	Value	Units	Ref
$\Delta Therms$	Annual fuel savings	Calculated	Therms/yr	
$\Delta Therms_{Peak}$	Daily peak fuel savings	Calculated	Therms/day	
$\Delta Therms_{Life}$	Lifetime fuel savings	Calculated	Therms	
GPD	Gallons per day	Calculated, if N_{ppt} unknown use 46	Gal/day	[221]
ΔT_{main}	Average temperature difference between water heater set point temperature (T_{set}) and the supply water temperature in water main (T_{main})	Calculated	°F	

Variable	Description	Value	Units	Ref
ΔT_{amb}	Average temperature difference between water heater set point temperature (T_{set}) and the surrounding ambient air temperature (T_{amb})	Calculated	°F	
UA_q	Overall heat loss coefficient of the energy efficient equipment	Calculated, if SL_q unknown use 5.4	(Btu/h-°F).	[226]
Eff_q	Efficiency of energy efficient connected boiler (AFUE)	Site-specific. If unknown use 0.85 ⁴²	N/A	
N_{ppl}	Number of people in household	Site-specific. If unknown use default GPM	N/A	
SL_q	Standby loss specification of installed equipment. Use given UA_q assumption if SL_q is unknown.	Site-specific	°F/hr	
V_q	Rated storage capacity of installed equipment	Site-specific	Gal	
UA_b	Overall heat loss coefficient of the baseline condition	7.85	(Btu/h-°F).	[224]
T_{set}	Water heater set point temperature	125	°F	[222]
T_{main}	Supply water temperature in water main	60	°F	[223]
T_{amb}	Surrounding ambient air temperature	70 ⁴³	°F	
Eff_b	Efficiency of the baseline condition, deemed (AFUE)	0.75	N/A	[224]
365	Days per year	365	Days/yr	
8,760	Hours per year	8,760	Hr/yr	
8.33	Energy required (Btu) to heat one gallon of water by one degree Fahrenheit	8.33	Btu/gal°F	
100,000	Conversion from Btu to therms	100,000	Btu/therm	
EUL	Effective useful life	See Measure Life Section	Years	
RUL	Remaining useful life of existing unit	See Measure Life Section	Years	

Peak Factors

Table 2-165 Peak Factors

Peak Factor	Value	Ref
Electric coincidence factor (CF)	N/A	
Natural gas peak day factor (PDF)	See Appendix G: Natural Gas Peak Day Factors	

⁴² ASHRAE 90.1 2019 Compliant AFUE values range from 82% to 84%. Assumed conservative estimate of 85%

⁴³ Water heaters are generally located in conditioned or partially conditioned spaces with a typical average temperature of 65°F to 70°F to avoid freezing. A value of 70°F is used for the purposes of estimating ambient air temperature

Measure Life

The remaining useful life (RUL) for existing equipment is limited to 1/3 of the effective useful life (EUL) of the equipment.

Table 2-166 Measure Life

Equipment	EUL	RUL	Ref
Indirect Water Heater	11	3.67	[227]

References

- [221] Water Research Foundation: *Residential End Uses of Water*, Version 2, April 2016, p. 5; 17.2 GPD equated from the report findings indicating an average 2.65 people per household and 45.5 GPD per household, April 2016
- [222] Code of Federal Regulations, Title 10, Chapter II, Subchapter D, Part 430, Appendix E to Subpart B of Part 430 Uniform Test Method for Measuring the Energy Consumption of Water Heaters, Section 2. Test Conditions, 2.5 Set Point Temperature, December 2022. <https://www.ecfr.gov/current/title-10/chapter-II/subchapter-D/part-430/subpart-B>.
- [223] Burch, Jay and Christensen, Craig, *Towards Development of an Algorithm for Mains Water Temperature*. National Renewable Energy Laboratory, 2022.
- [224] Per 10 CFR 430, typical recovery efficiency of a gas water heater, which is used for the purposes of this measure as a proxy for thermal efficiency, is 0.75. See for example, 10 CFR 430 Subpart B Appendix C1, 5.6.1.1., December 2022. <https://www.ecfr.gov/current/title-10/chapter-II/subchapter-D/part-430/subpart-B>.
- [225] Based on computation of heat loss coefficients via conversion equations found in 10 CFR 429, 430, and 431 Docket No. EERE-2015-BT-TP-0007, Energy Conservation Program for Consumer Products and Certain Commercial and Industrial Equipment, December 2022.
- [226] Based on the average standby loss specification (in °F/hr) of AHRI-certified Indirect Water Heater storage tanks, per the AHRI Directory, Air Conditioning, Heating, and Refrigeration Institute, December 2022. <https://ahridirectory.org>.
- [227] New York Standard Approach for Estimating Energy Savings from Energy Efficiency Programs (TRM), Version 9, January 2022. [https://www3.dps.ny.gov/W/PSCWeb.nsf/96f0fec0b45a3c6485257688006a701a/72c23decff52920a85257f1100671bdd/\\$FILE/NYS%20TRM%20V9.pdf](https://www3.dps.ny.gov/W/PSCWeb.nsf/96f0fec0b45a3c6485257688006a701a/72c23decff52920a85257f1100671bdd/$FILE/NYS%20TRM%20V9.pdf)

2.7.3 STORAGE WATER HEATER

Market	Residential/Multifamily
Baseline Condition	NC/TOS
Baseline	Code
End Use Subcategory	Equipment
Measure Last Reviewed	January 2023

Description

This measure covers the installation of storage tank water heaters designed to heat and store water at a thermostatically controlled temperature. This measure applies to potable hot water delivery only; it is not applicable to hot water heaters used for process loads or space heating. Additionally, qualifying equipment must be designed to heat water to a temperature no greater than 180°F.

Storage type units include residential gas storage water heaters with an input of 75,000 Btu per hour or less.

This measure applies to replacement of existing storage type water heaters using the same heating fuel as the efficient case and assumes baseline to be a minimally code compliant water heater of the same type and heating fuel as the efficient case. For new construction, this measure assumes baseline to be a minimally code compliant storage-type water heater using the same heating fuel as the efficient case.

Baseline Case

The baseline condition is a minimally code compliant water heater equivalent to the existing water heater and with tank volume, input capacity and draw pattern equivalent to the efficient water heater. For new construction, the baseline condition is a minimally code compliant storage-type water heater with tank volume, input capacity and draw pattern equivalent to the efficient water heater.

Efficient Case

The compliance condition is an ENERGY STAR® rated gas storage water heater as directed by the measure description. Efficient storage tank water heaters must be eligible under ENERGY STAR® Program Requirements for Residential Water Heaters, Eligibility Criteria Version 5.0, effective April 2023. [233] Minimum UEF qualification for ENERGY STAR® equipment is shown in Table 2-168.

Annual Energy Savings Algorithms

Annual Electric Energy Savings

$$\Delta kWh = N/A$$

Annual Fuel Savings

$$\Delta Therms = \frac{GPD \times 365 \times 8.33 \times \Delta T_{main}}{100,000} \times \left(\frac{1}{UEF_b} - \frac{1}{UEF_q} \right)$$

Where,

$$GPD = 17.2 \times N_{ppt}$$

$$\Delta T_{main} = T_{set} - T_{main}$$

Peak Demand Savings

$$\Delta kW_{Peak} = N/A$$

Daily Peak Fuel Savings

$$\Delta Therms_{Peak} = \Delta Therms \times PDF$$

Lifetime Energy Savings Algorithms

Lifetime Electric Energy Savings

$$\Delta kWh_{Life} = N/A$$

Lifetime Fuel Savings

$$\Delta Therms_{Life} = \Delta Therms \times EUL$$

Calculation Parameters

Table 2-167 Calculation Parameters

Variable	Description	Value	Units	Ref
$\Delta Therms$	Annual fuel savings	Calculated	Therms/yr	
$\Delta Therms_{Peak}$	Daily peak fuel savings	Calculated	Therms/day	
$\Delta Therms_{Life}$	Lifetime fuel savings	Calculated	Therms	
GPD	Gallons per day	Calculated, if unknown use 46	Gal/day	[228]
ΔT_{main}	Average temperature difference between water heater set point temperature and the supply water temperature in water main	Calculated	°F	
UEF_q	Uniform Energy Factor of the energy efficient measure	Site-specific, if unknown look up in Table 2-168	N/A	
N_{ppt}	Number of people served by the system, if unknown use default GPD assumption	Site-specific	Number of people	
T_{set}	Water heater set point temperature	125	°F	[229]
T_{main}	Supply water temperature in water main ⁴⁴	60	°F	[230]

⁴⁴ Average value across NJ climate zones, calculated as average ambient air temperature + 6 °F.

Variable	Description	Value	Units	Ref
UEF _b	Uniform Energy Factor of the baseline condition, based on tank volume	Look up in Appendix E: Code-Compliant Efficiencies	N/A	
8,760	Hours per year	8,760	Hours/yr	
365	Days per year	365	Days/yr	
3,412	Conversion from Btu to kWh	3,412	Btu/kWh	
8.33	Energy required (Btu) to heat one gallon of water by one degree Fahrenheit	8.33	Btu/gal°F	
100,000	Conversion from Btu to therms	100,000	Btu/therm	
17.2	Assumed gallons of hot water used per day per person in household	17.2	Gal/day/person	[228]
CF	Electric coincidence factor	Look up in Table 2-169	N/A	
PDF	Gas peak day factor	Look up in Table 2-169	N/A	
EUL	Effective useful life	See Measure Life Section	Years	

Table 2-168 Residential Water Heaters Energy Star Criteria

Product Class	Rated Storage Volume and Input Rating	Draw Pattern	Minimum UEF
Gas-Fired Storage Water Heater	> 20 gal and ≤ 55 gal	Medium	0.81
	> 20 gal and ≤ 55 gal	High	0.86
	> 55 gal	Medium	0.86

Peak Factors

Table 2-169 Peak Factors

Peak Factor	Value	Ref
Electric coincidence factor (CF)	0.8	[232]
Natural gas peak day factor (PDF)	See Appendix G: Natural Gas Peak Day Factors	

Measure Life

The effective useful life (EUL) is 11 years for gas water heaters and 13 years for electric water heaters. [231]

References

- [228] Water Research Foundation: “Residential End Uses of Water, Version 2: Executive Report”, April 2016, <https://www.mrwa.com/PDF/2016WaterEndUseReport.pdf>

- [229] 10 CFR 430 Appendix E to Subpart B of Part 430 Uniform Test Method for Measuring the Energy Consumption of Water Heaters, Section 2. Test Conditions, 2.5 Set Point Temperature
<https://www.ecfr.gov/current/title-10/chapter-II/subchapter-D/part430/subpart-B/appendix-E>
- [230] Calculated from annual NJ temperatures using methodology in Burch, Jay and Christensen, Craig, "Towards Development of an Algorithm for Mains Water Temperature." National Renewable Energy Laboratory, 2022
- [231] California Public Utilities Commission EUL Table, version 027 (updated November 12, 2022). Accessed December 30, 2022. <https://www.caetrm.com/shared-data/value-table/EUL/>
- [232] New York Standard Approach for Estimating Energy Savings from Energy Efficiency Programs (TRM), Version 9, January 2022.
[https://www3.dps.ny.gov/W/PSCWeb.nsf/96f0fec0b45a3c6485257688006a701a/72c23decff52920a85257f1100671bdd/\\$FILE/NYS%20TRM%20V9.pdf](https://www3.dps.ny.gov/W/PSCWeb.nsf/96f0fec0b45a3c6485257688006a701a/72c23decff52920a85257f1100671bdd/$FILE/NYS%20TRM%20V9.pdf).
- [233] Energy Star Residential Water Heaters Specification Final Draft v5.0
<https://www.energystar.gov/sites/default/files/asset/document/ENERGY%20STAR%20Version%205.0%20Residential%20Water%20Heaters%20Final%20Draft%20Specification.pdf>

2.7.4 TANKLESS WATER HEATER

Market	Residential/Multifamily/Low Income
Baseline Condition	NC/RF/DI
Baseline	Code/Existing/Dual
End Use Subcategory	Equipment
Measure Last Reviewed	December 2022

Description

This measure covers the installation of instantaneous type water heaters, which heat water but contain no more than one gallon of water per 4,000 Btu per hour of input. This measure applies to potable hot water delivery only; it is not applicable to hot water heaters used for process loads or space heating. Additionally, qualifying equipment must be designed to heat water to a temperature no greater than 180°F and, if electric power is required for operation, must use a single-phase external power supply.

Instantaneous type units include fossil fuel instantaneous water heaters with a rated input capacity of greater than or equal to 50,000 and less than 200,000 Btu per hour and a manufacturer's specified storage capacity of less than 2 gallons, residential electric instantaneous water heaters with an input of 12 kilowatts or less and a manufacturer's specified storage capacity of less than 2 gallons.

Baseline Case

The retrofit baseline condition is a minimally code compliant water heater of type (storage-type or instantaneous) equivalent to the existing water heater and with tank volume (where applicable), input capacity and draw pattern equivalent to the efficient water heater. For new construction, the baseline condition is a minimally code compliant 40-gallon storage-type with draw pattern equivalent to the efficient water heater (assume medium if unknown).

Efficient Case

The efficient case is an energy efficient fossil fuel or electric instantaneous type water heater as defined by the measure description.

Annual Energy Savings Algorithm

Annual Electric Energy Savings

$$\Delta kWh = kWh_b - kWh_q$$

Where,

$$kWh_b = \frac{GPD \times 365 \times 8.33 \times \Delta T_{main}}{3,412 \times UEF_b} \text{ (Electric Baseline)}$$

$$kWh_b = 0 \text{ (Fossil Fuel Baseline)}$$

$$kWh_q = \frac{GPD \times 365 \times 8.33 \times \Delta T_{main}}{3,412 \times UEF_q} \text{ (Electric Energy Efficient Case)}$$

$$kWh_q = 0 \text{ (Fossil Fuel Energy Efficient Case)}$$

$$GPD = 17.2 \times N_{ppt}$$

$$\Delta T_{main} = T_{set} - T_{main}$$

$$\Delta T_{amb} = T_{set} - T_{amb}$$

Annual Fuel Savings

$$\Delta Therms = Therms_b - Therms_q$$

Where,

$$Therms_b = \frac{GPD \times 365 \times 8.33 \times \Delta T_{main}}{100,000 \times UEF_b} \text{ (Fossil Fuel Baseline)}$$

$$Therms_b = 0 \text{ (Electric Baseline)}$$

$$Therms_q = \frac{GPD \times 365 \times 8.33 \times \Delta T_{main}}{100,000 \times UEF_q} \text{ (Fossil Fuel Energy Efficient Case)}$$

$$Therms_q = 0 \text{ (Electric Energy Efficient Case)}$$

$$GPD = 17.2 \times N_{ppt}$$

$$\Delta T_{main} = T_{set} - T_{main}$$

$$\Delta T_{amb} = T_{set} - T_{amb}$$

Peak Demand Savings

$$\Delta kW_{Peak} = \frac{(UA_b - UA_q) \times \Delta T_{amb}}{3,412} \times CF$$

Daily Peak Fuel Savings

$$\Delta Therms - day_{peak} = \Delta Therms \times PDF$$

Lifetime Energy Savings Algorithms

Lifetime Electric Energy Savings

New Construction:

$$\Delta kWh_{Life} = \Delta kWh \times EUL$$

Retrofit:

$$\Delta kWh_{Life} = \Delta kWh_{Ex} \times RUL + \Delta kWh_{NR} \times (EUL - RUL)$$

Where,

ΔkWh_{Ex} = annual energy savings calculated as above, using actual existing equipment baseline

ΔkWh_{NR} = annual energy savings calculated as above, using code baseline

Lifetime Fuel Savings

Retrofit:

$$\Delta Therms_{Life} = \Delta Therms \times EUL$$

New Construction:

$$\Delta Therms_{Life} = \Delta Therms_{Ex} \times RUL + \Delta Therms_{NR} \times (EUL - RUL)$$

Where,

$\Delta Therms_{Ex}$ = annual fuel savings calculated as above, using actual existing equipment baseline

$\Delta Therms_{NR}$ = annual fuel savings calculated as above, using code baseline

Calculation Parameters

Table 2-170 Calculation Parameters

Variable	Description	Value	Units	Ref
ΔkWh	Annual electric energy savings	Calculated	kWh/yr	
$\Delta Therms$	Annual fuel savings	Calculated	Therms/yr	
ΔkW_{Peak}	Peak Demand Savings	Calculated	kW	
$\Delta Therms\text{-}day_{Peak}$	Daily peak fuel savings	N/A	Therms/day	
ΔT_{main}	Average temperature difference between water heater set point temperature and the supply water temperature in water main (°F)	Calculated	°F	
ΔT_{amb}	Average temperature difference between water heater set point temperature and the surrounding ambient air temperature (°F)	Calculated	°F	
GPD	Gallons per day	Calculated, if N_{ppi} unknown, use 46	Gal/day	[234]

Variable	Description	Value	Units	Ref
N_{ppl}	Number of people in household	Site-specific. If unknown, use 2.65	N/A	[241]
T_{set}	Water heater set point temperature	Site-specific. If unknown, use 125	°F	[235]
T_{main}	Supply water temperature in water main	60	°F	[236]
T_{amb}	Surrounding ambient air temperature	70	°F	
UEF_b	Uniform Energy Factor of the baseline condition	Retrofit: Site-specific New construction: Look up in Appendix E: Code-Compliant Efficiencies	N/A	[239]
UEF_q	Uniform Energy Factor of the energy efficient measure.	Site-specific	N/A	
UA_b	Overall heat loss coefficient of the baseline condition.	Storage water heater baseline: $UA_b = 7.85$ Indirect water heater baseline: $UA_b = 0$	(Btu/h-°F).	[237]
UA_q	Overall heat loss coefficient of the energy efficient measure.	0	(Btu/h-°F).	[238]
365	Days per year	365	Days/yr	
3,412	Conversion from Btu to kWh	3,412	Btu/kWh	
8.33	Energy required (Btu) to heat one gallon of water by one degree Fahrenheit	8.33	Btu/gal-°F	
100,000	Conversion from Btu to therms	100,000	Btu/therm	
CF	Electric coincidence factor	Look up in Table 2-171	N/A	
PDF	Peak day factor	Look up in Table 2-171	N/A	
EUL	Effective useful life	See Measure Life Section	Years	

Peak Factors

Table 2-171 Peak Factors

Peak Factor	Value	Ref
Electric coincidence factor (CF)	0.8	[240]
Natural gas peak day factor (PDF)	N/A	

Measure Life

The remaining useful life (RUL) for retrofit projects is limited to 1/3 of the effective useful life (EUL) of the equipment.

Table 2-172 Measure Life

Equipment	New construction EUL	Retrofit RUL	Ref
Instantaneous Water Heater	20	6.66	[240]

References

- [234] Water Research Foundation: Residential End Uses of Water, Version 2, April 2016, p. 5; 17.2 GPD equated from the report findings indicating an average 2.65 people per household and 45.5 GPD per household, April 2016.
- [235] 10 CFR 430 Appendix E to Subpart B of Part 430 Uniform Test Method for Measuring the Energy Consumption of Water Heaters, Section 2. Test Conditions, 2.5 Set Point Temperature, December 2022.
- [236] Burch, Jay and Christensen, Craig, "Towards Development of an Algorithm for Mains Water Temperature." National Renewable Energy Laboratory, 2022.
- [237] Based on computation of heat loss coefficients via conversion equations found in 10 CFR 429, 430, and 431 Docket No. EERE-2015-BT-TP-0007, Energy Conservation Program for Consumer Products and Certain Commercial and Industrial Equipment, December 2022.
- [238] Based on the average standby loss specification (in °F/hr) of AHRI-certified Indirect Water Heater storage tanks, per the AHRI Directory, December 2022.
- [239] 10 CFR 430.32(d), December 2022.
- [240] New York Standard Approach for Estimating Energy Savings from Energy Efficiency Programs (TRM), Version 9, January 2022.
[https://www3.dps.ny.gov/W/PSCWeb.nsf/96f0fec0b45a3c6485257688006a701a/72c23decff52920a85257f1100671bdd/\\$FILE/NYS%20TRM%20V9.pdf](https://www3.dps.ny.gov/W/PSCWeb.nsf/96f0fec0b45a3c6485257688006a701a/72c23decff52920a85257f1100671bdd/$FILE/NYS%20TRM%20V9.pdf)
- [241] *Residential End Uses of Water: Version 2 Executive Report (Water Research Foundation)*, Pg 8.
https://www.circleofblue.org/wp-content/uploads/2016/04/WRF_REU2016.pdf

2.7.5 WATER HEATING SETBACK

Market	Residential/Multi-Family/Low Income
Baseline Condition	RF/DI
Baseline	Existing/Dual
End Use Subcategory	Control
Measure Last Reviewed	December 2022

Description

This measure relates to turning down an existing hot water tank thermostat setting that is at 130 degrees or higher. Savings are provided to account for the resulting reduction in standby losses. This is a retrofit measure.

Baseline Case

The baseline condition is a hot water tank with a thermostat setting that is 130 degrees or higher. Note if there are more than one DHW tanks in the home at or higher than 130 degrees and they are all turned down, then the savings per tank can be multiplied by the number of tanks.

Efficient Case

The efficient condition is a hot water tank with the thermostat reduced to no lower than 120 degrees.

Annual Energy Savings Algorithm

Annual Electric Energy Savings

$$\Delta kWh = \left(\frac{U \times A \times (T_b - T_q) \times Hrs}{3,412 \times RE_{electric}} \right)$$

Annual Fuel Savings

$$\Delta Therms = \left(\frac{U \times A \times (T_b - T_q) \times Hrs}{1,00,000 \times RE_{gas}} \right)$$

Peak Demand Savings

$$\Delta kW_{peak} = \frac{\Delta kWh}{Hrs} \times CF$$

Daily Peak Fuel Savings

$$\Delta Therms_{peak} = \Delta Therms \times PDF$$

Lifetime Energy Savings Algorithms

Lifetime Electric Energy Savings

$$\Delta kWh_{Life} = \Delta kWh \times EUL$$

Lifetime Fuel Savings

$$\Delta Therms_{Life} = \Delta Therms \times EUL$$

Dual:

Lifetime Electric Energy Savings

$$\Delta kWh_{Life} = \Delta kWh_{EREP} \times RUL + \Delta kWh_{NR} \times EUL$$

Lifetime Fuel Savings

$$\Delta Therms_{Life} = \Delta Therms_{EREP} \times RUL + \Delta Therms_{NR} \times EUL$$

Calculation Parameters

Table 2-173 Calculation Parameters

Variable	Description	Value	Units	Ref
ΔkWh	Annual electric energy savings	Calculated	kWh/yr	
$\Delta Therms$	Annual fuel savings	Calculated	Therms/yr	
ΔkW_{Peak}	Peak Demand Savings	Calculated	kW	
$\Delta Therms\text{-day}_{Peak}$	Daily peak fuel savings	Calculated	Therms/day	
$\Delta kWh_{Lifetime}$	Lifetime electric energy savings	Calculated	kWh	
$\Delta Therms_{Lifetime}$	Lifetime fuel savings	Calculated	Therms	
U	Overall heat transfer coefficient of tank	Site-specific, if unknown use 0.083 ⁴⁵	(Btu/Hr-°F-ft ²)	
A	Surface area of storage tank	Site-specific, if unknown look up in Table 2-174	Ft ²	[242]
T _b	Hot water setpoint prior to adjustment	Site-specific, if unknown use 130	°F	[245]
T _q	New hot water setpoint	Site-specific, if unknown, use 120	°F	[244]
Hours	Number of hours in a year	8760	Hrs/yr	
RE _{electric}	Recovery efficiency of water heater	Electric Hot Water Heater: 0.98 Heat Pump Water Heater: 2.1	N/A	[242]
RE _{gas}	Recovery efficiency of gas water heater	0.8	N/A	[243]

⁴⁵ Assumes R-12 water tank

Variable	Description	Value	Units	Ref
3,412	Conversion from Btu to kWh	3,412	Btu/kWh	
100,000	Conversion from Btu to therms	100,000	Btu/therm	
CF	Electric coincidence factor	Look up in Table 2-175	N/A	
EUL	Effective useful life	See Measure Life	Years	
RUL	Remaining useful life of existing unit	See Measure Life	Years	

Table 2-174 Assumed Surface Area of Storage Tank by Capacity

Capacity (in gallons)	Area (in square feet)
30	19.16
40	23.18
50	24.99
80	31.84

If capacity is unknown, assume a 50 gallon tank.

Peak Factors

Table 2-175 Peak Factors

Peak Factor	Value	Ref
Electric coincidence factor (CF)	1	
Natural gas peak day factor (PDF)	N/A	

Measure Life

The effective useful life for water heating setback is the smaller of 2 years or the remaining useful life of the water heater [244].

References

- [242] Assumptions from Pennsylvania TRM. Area values were calculated from average dimensions of several commercially available units, with radius values measured to the center of the insulation, December 2022. [https://www.puc.pa.gov/filing-resources/issues-laws-regulations/act-129/technical-reference-manual/Code of Federal Regulations, Title 10, Chapter II, Subchapter D, Part 430, Subpart B, Appendix E – Uniform Test Method for Measuring the Energy Consumption of Water Heaters: 6.3.2 Recovery Efficiency](https://www.puc.pa.gov/filing-resources/issues-laws-regulations/act-129/technical-reference-manual/Code%20of%20Federal%20Regulations,%20Title%2010,%20Chapter%20II,%20Subchapter%20D,%20Part%20430,%20Subpart%20B,%20Appendix%20E%20%E2%80%93%20Uniform%20Test%20Method%20for%20Measuring%20the%20Energy%20Consumption%20of%20Water%20Heaters:%206.3.2%20Recovery%20Efficiency), December 2022. <https://www.ecfr.gov/current/title-10/chapter-II/subchapter-D/part-430/subpart-B#Appendix-E-to-Subpart-B-of-Part-430>.
- [243] Code of Federal Regulations, Title 10, Chapter II, Subchapter D, Part 431, Section 431.110 (a) – Energy Conservation Standards and their Effective Dates. December 2022. <https://www.ecfr.gov/current/title-10/chapter-II/subchapter-D/part-431#431.110>.

[244] Mid-Atlantic TRM V10, December 2022.

https://neep.org/sites/default/files/resources/Mid_Atlantic_TRM_V9_Final_clean_wUpdateSummary%20-%20CT%20FORMAT.pdf.

[245] *Technical Reference Manual Volume 2: Residential Measures (2019)*; Pg 73,

<https://www.puc.pa.gov/filing-resources/issues-laws-regulations/act-129/technical-reference-manual/>

2.7.6 FAUCET AERATORS AND SHOWERHEADS

Market	Residential/Multifamily
Baseline Condition	DI/TOS
Baseline	Existing/Dual
End Use Subcategory	Water Conservation
Measure Last Reviewed	December 2022

Description

This measure presents the assumptions, analysis, and savings from adding low-flow aerators to faucets in kitchens and bathrooms, and for replacing standard showerheads with low-flow showerheads.

Savings for low-flow fixture measures are determined using the total change in flow rate (gallons per minute) from the baseline (existing) fixture to the low-flow fixture. This measure applies to residential and multifamily buildings.

Baseline Case

The baseline is a standard faucet with a 2.2 GPM flow rate or a standard showerhead meeting federal maximum flow of 2.5 GPM. For direct install programs, utilities may choose to measure the actual flow rate of the existing faucet for use in the algorithm below.

Efficient Case

The efficient condition is an energy efficient faucet aerator or showerhead using rated GPM of the installed fixture meeting requirements of NJ P.L. 2021, c. 464. If actual flow rates of the baseline fixtures are used in a direct install program, then the actual flow rate of the installed fixture should be used as well.

Annual Energy Savings Algorithm

Annual Electric Energy Savings

$$\Delta kWh = \Delta H_2O \times \Delta T_{main} \times \frac{8.33}{3,412} \times \frac{1}{UEF} \times F_{elec}$$

Where,

$$\text{Aerators: } \Delta T_{main} = T_{faucet} - T_{main}$$

$$\text{Showerheads: } \Delta T_{main} = T_{shower} - T_{main}$$

$$\text{Aerators: } \Delta H_2O = (GPM_b \times F_{Throttle,b} - GPM_q \times F_{Throttle,q}) \times \frac{1}{N_{faucet}} \times t_{use} \times N_{persons} \times 365$$

$$\text{Showerheads: } \Delta H_2O = (GPM_b \times F_{Throttle,b} - GPM_q \times F_{Throttle,q}) \times \frac{1}{N_{shower}} \times t_{use} \times N_{persons} \times 365$$

Annual Fuel Savings

$$\Delta Therms = \Delta H_2O \times \Delta T_{main} \times \frac{8.33}{100,000} \times \frac{1}{UEF}$$

Peak Demand Savings

$$\Delta kW_{Peak} = \Delta kWh \times E T D F$$

Daily Peak Fuel Savings

$$\Delta Therms_{Peak} = \Delta Therms \times P D F$$

Lifetime Energy Savings Algorithms:

Lifetime Electric Energy Savings

$$\Delta kWh_{Life} = \Delta kWh \times E U L$$

Lifetime Fuel Savings

$$\Delta Therms_{Life} = \Delta Therms \times E U L$$

Dual:

Lifetime Electric Energy Savings

$$\Delta kWh_{Life} = \Delta kWh_{EREP} \times R U L + \Delta kWh_{NR} \times E U L$$

Lifetime Fuel Savings

$$\Delta Therms_{Life} = \Delta Therms_{EREP} \times R U L + \Delta Therms_{NR} \times E U L$$

Calculation Parameters

Table 2-176 Calculation Parameters

Variable	Description	Value	Units	Ref
ΔkWh	Annual electric energy savings	Calculated	kWh/yr	
$\Delta Therms$	Annual fuel savings	Calculated	Therms/yr	
ΔkW_{Peak}	Peak Demand Savings	Calculated	kW	
$\Delta Therms_{Peak}$	Daily peak fuel savings	Calculated	Therms/day	

Variable	Description	Value	Units	Ref
ΔkWh_{Life}	Lifetime electric energy savings	Calculated	kWh	
$\Delta Therms_{Life}$	Lifetime fuel savings	Calculated	Therms	
ΔH_2O	Annual water savings	Calculated	Gal/yr	
ΔT_{main}	Average temperature different between faucet operating temperature and the supply water temperature	Calculated	°F	
UEF	Uniform Energy Factor ⁴⁶	Site-specific. If unknown, assume 0.92 (electric) or 0.58 (gas)	N/A	[253]
F_{elec}	Factor to account for presence or absence of electric water heater	1 if electric water heater; 0 if gas water heater; 0.25 ⁴⁷ if unknown	N/A	
F_{gas}	Factor to account for presence or absence of fossil fuel water heater	1 if gas water heater; 0 if electric water heater; 0.71 ² if unknown	N/A	
N_{faucet}	Faucets per household	Site-specific. If unknown, look up in Table 2-177	N/A	[252]
N_{shower}	Showers per household	Site-specific, if unknown: QHEC: 1.56 HPwES: 2.46	N/A	[257]
$N_{persons}$	Average number of people per household	Site-specific. If unknown, assume 2.66	Person/ household	[246]
GPM_b	Baseline GPM	Site-specific or use 2.2	Gal/min	[251][248]
GPM_q	Efficient GPM	Look up in Table 2-177	Gal/min	[251]
t_{use}	Average minutes of use per person per fixture per day	Look up in Table 2-177	Minutes/ person/day	[247]
$F_{throttle, b}$	Ratio of user setting to full throttle flow rate for baseline fixture	Aerator: 0.83 Showerhead: 0.9	N/A	[250], [258]
$F_{throttle, q}$	Ratio of user setting to full throttle flow rate for low flow fixture	Aerator: 0.95 Showerhead: 0.9	N/A	[250], [258]
T_{Main}	Supply water temperature in water main ⁴⁸	60	°F	[249]

⁴⁶ Take UEF from application using the existing water heater's model number lookup. If unknown, then UEF is determined by the Department of Energy's test method outlined in 10 CFR Part 430, Subpart B, Appendix E (accessible here: <https://www.ecfr.gov/current/title-10/chapter-II/subchapter-D/part-430/subpart-C/section-430.32>).

Assume medium draw pattern if unknown. If storage capacity is also unknown, use the assumptions above for a 40 gallon, medium draw, electric or gas storage water heater.

⁴⁷ From 2015 RECS microdata for Middle Atlantic Div 8. Of 228 households, fuel mix for water heating is 71% gas and 25% electric. No savings are attributed to 4% of households which use other fuel sources.

⁴⁸ Average value across 5 NJ climate zones. Calculated from annual average ambient air temperature + 6°F. See Reference [249].

Variable	Description	Value	Units	Ref
T_{faucet}	Faucet exiting temperature	Site-specific. If unknown, look up in Table 2-177	°F	[254]
T_{shower}	Showerhead existing temperature	Site specific, use 105 if unknown	°F	[256]
ETDF	Energy to Demand Factor	Aerator: 0.000134 Showerhead: 0.00008014	(kW/kWh/yr)	[248]
8.33	Energy required to heat one gallon of water by one degree Fahrenheit	8.33	Btu/gal°F	
3,412	Conversion factor from Btu/h to kW	3,412	Btu/h/kW	
100,000	Conversion factor from Btu to therms	100,000	Btu/therm	
365	Number of days per year	365	Days/yr	
PDF	Peak day factor	Look up in Table 2-178		
EUL	Effective useful life	See Measure Life Section		
RUL	Remaining useful life of existing unit	See Measure Life Section	Years	

Table 2-177 Calculation Assumptions per Faucet Type

Faucet Type	Efficient gallons per minute (GPM_q)	Daily use duration (t_{use})	Operating temperature (T_{faucet}) (°F)	Faucets/household (N_{faucet})
Kitchen	1.8	4.5	93	1
Private restroom	1.5	1.6	86	1.75
Public restroom	0.5	1.6	86	N/A

Peak Factors

Electric coincidence is included in the ETDF factor.

Table 2-178 Peak Factors

Peak Factor	Value	Ref
Electric coincidence factor (CF)	N/A	
Natural gas peak day factor (PDF)	See Appendix G: Natural Gas Peak Day Factors	

Measure Life

The remaining useful life (RUL) for existing equipment is limited to 1/3 of the effective useful life (EUL) of the equipment.

Table 2-179 Measure Life

Equipment	EUL	RUL	Ref
Faucet Aerator	10	3.3	[255]

Non-Energy Impacts

$$\Delta H_2O = (GPM_b \times F_{Throttle,b} - GPM_q \times F_{Throttle,q}) \times \frac{1}{N_{faucet}} \times t_{use} \times N_{persons} \times 365$$

References

- [246] Explore Census Data. n.d. Data.census.gov. Accessed December 1, 2022. <https://data.census.gov/table?q=average+household+size&g=0400000US34&y=2020&tid=ACSDT5Y2020.B25010>
- [247] Cadmus, *2014 Demand-Side Management Evaluation Final Report* (2014), Table 93.
- [248] Pennsylvania Technical Reference Manual; effective June 2016, pp. 114ff. <http://www.puc.pa.gov/pcdocs/1370278.docx>
- [249] Burch, Jay and Christensen, Craig, *Towards Development of an Algorithm for Mains Water Temperature*. National Renewable Energy Laboratory. <https://citeseerx.ist.psu.edu/viewdoc/download?doi=10.1.1.515.6885&rep=rep1&type=pdf>
- [250] American Council for an Energy-Efficient Economy, *Energy Related Water Fixture Measurements: Securing the Baseline for Northwest Single Family Homes*, August 2008, pg. 1-265.
- [251] Baseline flow rates for new aerators established by New Jersey P.L. 2021, c. 464 minimum standards.
- [252] American Housing Survey Table Creator, United States Census Bureau, *Housing Unit Characteristics*, New York 2017.
- [253] UEF assumptions per 10 CFR Part 430, Subpart B, Appendix E. <https://www.ecfr.gov/current/title-10/chapter-II/subchapter-D/part-430/subpart-C/section-430.32>; assuming medium draw pattern, 40 gallon storage water heater.
- [254] *Michigan Evaluation Working Group Showerhead and Faucet Aerator Meter Study*. June 2013, via 2014 Demand-Side Management Evaluation Final Report, Cadmus, June 30, 2015, Table 93.
- [255] DEER 2014 EUL ID: WtrHt-WH-Aertr.
- [256] Lutz, Jim. 2011. "Water and Energy Wasted during Residential Shower Events: Findings from a Pilot Field Study of Hot Water Distribution Systems." https://eta-publications.lbl.gov/sites/default/files/water_and_energy_wasted_during_residential_shower_events_findings_from_a_pilot_field_study_of_hot_water_distribution_systems_lbnl-5115e.pdf.
- [257] American Housing Survey (AHS) - AHS Table Creator." n.d. Wwww.census.gov. Accessed December 1, 2022. https://www.census.gov/programs-surveys/ahs/data/interactive/ahstablecreator.html?s_areas=35620&s_year=2021&s_tablename=TABLE0&s_bygroup1=1&s_bygroup2=1&s_filtergroup1=1&s_filtergroup
- [258] Biermayer, Peter, and Ernest Lawrence. 2006. "LBNL-58601-Revised Potential Water and Energy Savings from Showerheads." <https://www.map-testing.com/assets/reports/LBNL%20Showerhead-final%20rpt.pdf>.

2.7.7 THERMOSTATIC SHOWERHEADS

Market	Residential/Multifamily
Baseline Condition	RF/DI
Baseline	Existing
End Use Subcategory	Water Conservation
Measure Last Reviewed	December 2022

Description

This measure covers the installation of thermostatic shower restriction valves, which are valves attached to a showerhead supply for reduction of domestic hot water flow and associated energy usage in a single or multi-family household.

The device restricts hot water flow through the showerhead by activating the trickle or stop flow mode when water reaches a predetermined set temperature, as designed by the manufacturer.

The throttle factor should be used only when rated flows are used and not the actual measured flow.

Baseline Case

The baseline equipment is the residential showerhead without the restrictor valve installed.

Efficient Case

To qualify for this measure the installed equipment must be a thermostatic restrictor shower valve installed on a residential showerhead.

Annual Energy Savings Algorithm

Annual Electric Energy Savings

$$\Delta kWh = GPM \times F_{Throttle} \times Min_{Waste} \times \frac{Person}{Household} \times \frac{Showers}{Person/Day} \times \frac{365}{N_{Shower}} \times 8.33 \times \frac{T_{Shower} - T_{Main}}{UEF \times 3,412} \times ISR \times F_{Elec}$$

Annual Fuel Savings

$$\Delta Therms = GPM \times F_{Throttle} \times Min_{Waste} \times \frac{Person}{Household} \times \frac{Showers}{Person/Day} \times \frac{365}{N_{Shower}} \times 8.33 \times \frac{T_{Shower} - T_{Main}}{UEF \times 100,000} \times ISR \times F_{NG}$$

Peak Demand Savings

$$\Delta kW_{Peak} = \Delta kWh \times ETDf$$

Daily Peak Fuel Savings

$$\Delta Therms_{Peak} = \Delta Therms \times PDF$$

Lifetime Energy Savings Algorithms

Lifetime Electric Energy Savings

$$\Delta kWh_{Life} = \Delta kWh \times EUL$$

Lifetime Fuel Savings

$$\Delta Therms_{Life} = \Delta Therms \times EUL$$

Calculation Parameters

Table 2-180 Calculation Parameters

Variable	Description	Value	Units	Ref
ΔkWh	Annual electric energy savings	Calculated	kWh/yr	
$\Delta Therms$	Annual fuel savings	Calculated	Therms/yr	
ΔkW_{Peak}	Peak Demand Savings	Calculated	kW	
$\Delta Therms_{Peak}$	Daily peak fuel savings	Calculated	Therms/day	
ΔkWh_{Life}	Lifetime electric energy savings	Calculated	kWh	
$\Delta Therms_{Life}$	Lifetime fuel savings	Calculated	Therms	
GPM	Flow rate of the showerhead	Site-specific, if unknown look up in Table 2-181	Gal/min	[259][266]
Person/Household	Average number of people per household	Site-specific, if unknown assume 2.66	Person/ household	[261]
Showers/person/day	Showers Per Capita Per Day	Site-specific, if unknown assume 0.75	Showers/person/day	[262]
N_{Shower}	Average number of showerheads Per Household	Site-specific, if unknown assume 1.10	N/A	[263]
UEF	Uniform Energy Factor	Site-specific, if unknown assume 0.92 (electric) or 0.58 (gas)	N/A	[267]
F_{Elec}	Water heater fuel factor - electric	Look up in Table 2-182	N/A	
F_{NG}	Water heater fuel factor - gas	Look up in Table 2-182	N/A	
$F_{Throttle}$	Ratio of actual shower gpm to showerhead rated gpm	0.9	N/A	[262]
Min_{Waste}	Hot water waste time avoided due to thermostatic restrictor valve	0.98	Minutes	[260]

Variable	Description	Value	Units	Ref
T _{Shower}	Temperature at showerhead	105	°F	[264]
T _{Main}	Supply water temperature in water main ⁴⁹	60	°F	
ISR	In-Service Rate	1	N/A	
8.33	Energy required to heat one gallon of water by one degree Fahrenheit	8.33	Btu/gal°F	
3,412	Conversion factor from Btu/h to kW	3,412	Btu/h/kW	
100,000	Conversion factor from Btu to therms	100,000	Btu/therm	
365	Number of days per year	365	Days/yr	
ETDF	Energy to Demand Factor	0.00008014	(kW/ kWh/yr)	[265]
CF	Electric coincidence factor	Look up in Table 2-183	N/A	
PDF	Gas peak demand factor	Look up in Table 2-183	N/A	
EUL	Effective useful life of new unit	See Measure Life Section	Years	
RUL	Remaining useful life of existing unit	See Measure Life Section	Years	

Table 2-181 GPM

Installation case	GPM
Existing Showerhead	2.5
New Conventional Showerhead	2.0
Low Flow Showerhead	1.5

Table 2-182 Water Heater Fuel Factors

Water Heater Fuel Type	F _{Elec}	F _{NG}
Electric	1	0
Gas	0	1
Unknown	0.18	0.82

⁴⁹ Average value across 5 NJ climate zones. Calculated from annual average ambient air temperature + 6°F.

Peak Factors

Table 2-183 Peak Factors

Peak Factor	Value	Ref
Electric coincidence factor (CF)	N/A ⁵⁰	
Natural gas peak day factor (PDF)	See Appendix G: Natural Gas Peak Day Factors	

Measure Life

Table 2-184 Measure Life

Equipment	EUL	RUL	Ref
Thermostatic Showerheads	10	3.3	[268]

References

- [259] Cadmus and Opinion Dynamics Evaluation Team. *Showerhead and Faucet Aerator Meter Study: For Michigan Evaluation Working Group*. (June, 2013).
- [260] Cadmus memo to PPL Electric. *PPL Electric 2014 ShowerStart Pilot Study*. (November 2014).
- [261] Explore Census Data." n.d. Data.census.gov. Accessed December 1, 2022. <https://data.census.gov/table?q=average+household+size&g=0400000US34&y=2020&tid=ACSDT5Y2020.B25010>.
- [262] Biermayer, Peter. 2006. "LBNL-58601-Revised Potential Water and Energy Savings from Showerheads." <https://www.map-testing.com/assets/reports/LBNL%20Showerhead-final%20rpt.pdf>.
- [263] American Housing Survey (AHS) - AHS Table Creator." n.d. Www.census.gov. Accessed December 1, 2022. https://www.census.gov/programs-surveys/ahs/data/interactive/ahstablecreator.html?s_areas=35620&s_year=2021&s_tablename=TABLE0&s_bygroup1=1&s_bygroup2=1&s_filtergroup1=1&s_filtergroup
- [264] Lutz, Jim. 2011. "Water and Energy Wasted during Residential Shower Events: Findings from a Pilot Field Study of Hot Water Distribution Systems." https://eta-publications.lbl.gov/sites/default/files/water_and_energy_wasted_during_residential_shower_events_findings_from_a_pilot_field_study_of_hot_water_distribution_systems_lbnl-5115e.pdf.
- [265] Aquacraft, Inc., Water Engineering and Management. The end use of hot water in single family homes from flow trace analysis. 2001. https://www.researchgate.net/publication/252083793_THE_END_USES_OF_HOT_WATER_IN_SINGLE_FAMILY_HOMES_FROM_FLOW_TRACE_ANALYSIS The CF for showerheads is found to be 0.00371: [% showerhead use during peak × (TPerson-Day × NPerson) / (S/home)] / 240 (minutes in peak period) = [11.7% × (7.8 × 2.6 × 0.6 / 1.6)] / 240 = 0.00371. The Hours for showerheads is found to be 46.3: (TPerson-Day × NPersons × 365) / (S/home) / 60 = (7.8 × 2.6 × 0.6 × 365) / 1.6 / 60 = 46.3. The resulting FED is calculated to be 0.00008013: CF / Hours = 0.00371 / 46.3 = 0.00008013.
- [266] Maximum flowrates for new showerheads taken from New Jersey P.L. 2021, c. 464 Enacted January 2022. <https://legiscan.com/NJ/bill/A5160/2020>

⁵⁰ Peak electric demand embedded in ETDF.

[267] Take UEF from application using the existing water heater's model number lookup. If unknown, then UEF is determined by the Department of Energy's test method outlined in 10 CFR Part 430, Subpart B, Appendix E (accessible here: <https://www.ecfr.gov/current/title-10/chapter-II/subchapter-D/part-430/subpart-C/section-430.32>). Assume medium draw pattern if unknown. If storage capacity is also unknown, use the assumptions above for a 40 gallon, medium draw, electric or gas storage water heater.

[268] California Public Utilities Commission EUL Table, version 027 (updated November 12, 2022). Accessed December 30, 2022. <https://www.caetrm.com/shared-data/value-table/EUL/>

2.7.8 PIPE INSULATION

Market	Residential/Multifamily
Baseline Condition	RF/DI
Baseline	Existing/Dual
End Use Subcategory	Insulation
Measure Last Reviewed	November 2022

Description

This measure covers the installation of fiberglass, rigid foam, and cellular glass pipe insulation on exposed and uninsulated metal or steel piping with a nominal diameter between 0.50" and 4.00" for hot water and steam type space heating and/or domestic hot water (DHW) distribution systems in residential buildings. The measure is restricted to insulation of hot water distribution pipe in unconditioned spaces only. Space heating pipe insulation is limited to insulation installed in unheated spaces only. Insulation of CPVC, PEX, and HDPE piping is not eligible for savings under this measure due to low potential of savings.

In New Jersey the 2021 International Energy Conservation Code (IECC) generally defines the residential energy efficiency code requirements, but the IECC does not include residential service water heating provisions, leaving federal equipment efficiency standards to define baseline.

This measure caters for all insulation type given that they are IECC 2021 code compliant and are installed by certified professionals. The R-value of an insulation is the thermal resistance of its constituent material, which is derived by dividing the thickness of the material by the material's thermal conductivity, or k-value. Thermal transmittance, or the material's U-factor, is the inverse of the R-value.

Baseline Case

The baseline condition is uninsulated copper or steel domestic hot water or space heating piping located in an unconditioned space.

Efficient Case

The efficient case is insulated copper or steel domestic hot water or space heating piping located in an unconditioned space conforming to the requirements of IECC 2021 Section R403.5.2 which require hot water piping with 3/4" nominal diameter and larger to be insulated with a minimum thermal resistance of R-3.

Annual Energy Savings Algorithm

Annual Electric Energy Savings

$$\Delta kWh = \frac{\left[\left(\frac{UA}{L} \right)_b - \left(\frac{UA}{L} \right)_q \right] \times L \times (T_{pipe} - T_{amb}) \times hrs \times SF_{elec}}{Et_{elec} \times 3,412}$$

Annual Fuel Savings

$$\Delta Therms = \frac{\left[\left(\frac{UA}{L} \right)_b - \left(\frac{UA}{L} \right)_q \right] \times L \times (T_{pipe} - T_{amb}) \times hrs \times SF_{fuel}}{Et_{fuel} \times 100,000}$$

Peak Demand Savings

$$\Delta kW_{peak} = \frac{\Delta kWh}{8,760} \times CF$$

Daily Peak Fuel Savings

$$\Delta Therms_{peak} = \Delta Therms \times PDF$$

Lifetime Energy Savings Algorithms

Lifetime Electric Energy Savings

$$\Delta kWh_{Life} = \Delta kWh \times EUL$$

Lifetime Fuel Savings

$$\Delta Therms_{Life} = \Delta Therms \times EUL$$

Dual:

Lifetime Electric Energy Savings

$$\Delta kWh_{Life} = \Delta kWh_{EREP} \times RUL + \Delta kWh_{NR} \times EUL$$

Lifetime Fuel Savings

$$\Delta Therms_{Life} = \Delta Therms_{EREP} \times RUL + \Delta Therms_{NR} \times EUL$$

Calculation Parameters

Table 2-185 Calculation Parameters

Variable	Description	Value	Units	Ref
ΔkWh	Annual electric energy savings	Calculated	kWh/yr	
$\Delta Therms$	Annual fuel savings	Calculated	Therms/yr	
ΔkW_{Peak}	Peak Demand Savings	Calculated	kW	
$\Delta Therms_{Peak}$	Daily peak fuel savings	Calculated	Therms/day	
ΔkWh_{Life}	Lifetime electric energy savings	Calculated	kWh	
$\Delta Therms_{Life}$	Lifetime fuel savings	Calculated	Therms	

Variable	Description	Value	Units	Ref
L	Length of installed insulation	Site-specific	ft	
T_{pipe}	Average temperature of hot water or steam in distribution system piping	Site-specific, if unknown: DHW: 125 HW Boiler ⁵¹ : 160 Steam Boiler ⁵² : 212	°F	[273]
T_{amb}	Surrounding average ambient air temperature	Site-specific, if unknown: DHW: 70 Space Heat: 50	°F	[276]
E_{fuel}	Recovery Efficiency of fuel water heaters or AFUE of boiler for space heating	Site-specific, if unknown: DHW ⁵³ : 0.75 Space Heating Boilers: Look up in Table 2-188	N/A	[271][278]
E_{elec}	Recovery Efficiency of electric water heaters	Site-specific, if unknown: Non- Heat Pump DHW ⁵⁴ : 0.98 Heat Pump DHW: Look up in Table 2-189	N/A	[272][274]
hrs	Annual operating hours	For DHW: 8,760 Boilers: Look up heating EFLH in Appendix C: Heating and Cooling EFLH	hrs	[279]
$(UA/L)_b$	Product of Overall Heat Transfer Coefficient and Pipe Area (UA) per foot from uninsulated pipe ⁵⁵	Look up in Table 2-186	Btu/hr-°F-ft	[275]
$(UA/L)_q$	Product of Overall Heat Transfer Coefficient and Pipe Area (UA) per foot from insulated pipe ⁵⁵	Look up in Table 2-187	Btu/hr-°F-ft	[280]
SF_{elec}	Adjustment to electric water heating energy savings based on water heating fuel	Electric WH: 1.0 Fossil Fuel WH: 0 Unknown WH ⁵⁶ : 0.18	N/A	[277]

⁵¹ Average of lowest typical hot water boiler setting of (120°F) and highest typical setting of (200°F).

⁵² Residential boiler's steam temperature shall be the boiling point of water at sea level (212°F).

⁵³ Nominal gas or oil water heater recovery efficiency taken by CFR is 75% for deriving water energy consumption of consumer products such as dishwashers, etc. [271]

⁵⁴ The CFR Uniform Test Method for the measurement of Standby Loss of Electric Storage Water Heaters, electric Storage-Type Instantaneous Water Heaters, and electric Instantaneous Water Heaters (Other Than Storage-Type Instantaneous Water Heaters) uses 98% efficiency for electric water heaters with immersed heating elements. [271]

⁵⁵ Also called Building Load Coefficient per unit length.

⁵⁶ "Unknown" calculated as the number of homes with electric water heating divided by the total number of homes with water heating in EIA Residential Energy Consumption Survey (RECS) 2015 for Middle Atlantic States, Table HC8.7.

Variable	Description	Value	Units	Ref
SF _{fuel}	Adjustment to fossil fuel water heating energy savings based on water heating fuel	Electric WH: 0 Fossil Fuel WH: 1.0 Unknown WH ⁵⁷ : 0.82	N/A	[277]
CF	Electric coincidence factor	Look up in Table 2-190	N/A	
PDF	Gas peak day factor	Look up in Table 2-190	N/A	
EUL	Effective useful life	See Measure Life Section	Years	
RUL	Remaining useful life of existing unit	See Measure Life Section	Years	

Table 2-186 (UA/L)_{baseline}

Nominal Pipe Diameter (in)	Bare Copper Piping			Bare Steel Piping	
	Domestic Hot Water	Hot Water Heat	Steam Heat	Hot Water Heat	Steam Heat
0.50	0.44	0.48	0.53	0.53	0.59
0.75	0.54	0.58	0.64	0.65	0.72
1.00	0.65	0.70	0.78	0.79	0.88
1.25	0.80	0.86	0.96	0.97	1.09
1.50	0.90	0.97	1.09	1.10	1.23
2.00	1.10	1.19	1.33	1.34	1.51
2.50	1.31	1.42	1.58	1.60	1.80
3.00	1.57	1.70	1.90	1.92	2.16
3.50	1.77	1.92	2.15	2.18	2.45
4.00	1.98	2.14	2.40	2.43	2.73

Table 2-187 (UA/L)_q

Nominal Pipe Diameter (in)	Fiberglass						Rigid Foam/Cellular Glass					
	0.5 in	1 in	1.5 in	2 in	2.5 in	3 in	0.5 in	1 in	1.5 in	2 in	2.5 in	3 in
0.50	0.13	0.09	0.08	0.07	0.06	0.06	0.15	0.12	0.10	0.09	0.09	0.08
0.75	0.14	0.11	0.09	0.08	0.07	0.07	0.17	0.13	0.11	0.10	0.10	0.09
1.00	0.17	0.12	0.10	0.09	0.08	0.07	0.19	0.15	0.13	0.12	0.11	0.10
1.25	0.20	0.14	0.11	0.10	0.09	0.08	0.23	0.17	0.15	0.13	0.12	0.11

⁵⁷ "Unknown" calculated as the number of homes with gas water heating divided by the total number of homes with water heating in EIA Residential Energy Consumption Survey (RECS) 2015 for Middle Atlantic States, Table HC8.7.

Nominal Pipe Diameter (in)	Fiberglass						Rigid Foam/Cellular Glass					
	0.5 in	1 in	1.5 in	2 in	2.5 in	3 in	0.5 in	1 in	1.5 in	2 in	2.5 in	3 in
1.50	0.22	0.15	0.12	0.11	0.10	0.09	0.25	0.19	0.16	0.14	0.13	0.12
2.00	0.26	0.18	0.14	0.12	0.11	0.10	0.29	0.22	0.18	0.16	0.14	0.13
2.50	0.30	0.20	0.16	0.14	0.12	0.11	0.34	0.25	0.20	0.18	0.16	0.15
3.00	0.35	0.24	0.18	0.16	0.14	0.12	0.39	0.29	0.23	0.20	0.18	0.16
3.50	0.40	0.26	0.20	0.17	0.15	0.13	0.44	0.32	0.26	0.22	0.20	0.18
4.00	0.44	0.29	0.22	0.18	0.16	0.14	0.48	0.35	0.28	0.24	0.21	0.19

Table 2-188 E_{fuel} for Space Heating Boilers

Product Class	AFUE (Manufactured before 9/1/2012)	AFUE (Manufactured on/after 9/1/2012, before 1/15/2021)	AFUE (Manufactured on/after 1/15/2021)
Gas-fired hot water boiler	0.80	0.82	0.84
Gas-fired steam boiler	0.75	0.80	0.82
Oil-fired hot water boiler	0.80	0.84	0.86
Oil-fired steam boiler	0.80	0.82	0.85

Table 2-189 E_{elec} for Domestic Hot Water Heaters

Size (Gallons)	UEF	E_{elec}
50	3.30	2.83
50	3.50	2.92
50	3.75	3.14
65	3.30	2.85
65	3.50	2.94
65	3.75	3.24
80	3.30	2.85
80	3.50	3.01
80	3.75	3.38

Size (Gallons)	UEF	E _{elec}
Unknown Size ⁵⁸	-	3.016

Peak Factors

Table 2-190 Peak Factors

Peak Factor	Value	Ref
Electric coincidence factor (CF)	DHW: 1.0 Space Heat: N/A	
Natural gas peak day factor (PDF)	See Appendix G: Natural Gas Peak Day Factors	

Measure Life

The remaining useful life (RUL) for existing equipment is limited to 1/3 of the effective useful life (EUL) of the equipment.

Table 2-191 Measure Life

Equipment	EUL	RUL	Ref
Electric Water Heaters	13	4.33	[281]
Gas Water Heaters	11	3.66	[281]

References

- [269] 2022 Illinois Statewide Technical Reference Manual for Energy Efficiency. 2021, Page 88.
https://www.ilsag.info/wp-content/uploads/IL-TRM_Effective_010122_v10.0_Vol_3_Res_09242021.pdf
- [270] Pipe Sizing Charts Tables | Energy-Models.com. 2013. Energy-Models.com. 2013. <https://energy-models.com/pipe-sizing-charts-tables>.
- [271] Code of Federal Regulations. 2022. Review of Title 10, Chapter II, Subchapter D, Part 430 eCFR. December 1, 2022.
<https://www.ecfr.gov/current/title-10/chapter-II/subchapter-D/part-430>
- [272] 2022 California Public Utilities Commission. n.d. Review of DEER Resources - Water Heater - DEER Water Heater Calculator. Cedars - California Energy Data and Reporting System.
<https://cedars.sound-data.com/deer-resources/tools/water-heaters/>.
- [273] Code of Federal Regulations. 2022. Review of Title 10, Chapter II, Subchapter B, Part 430, Appendix E - Uniform Test Method for Measuring the Energy Consumption of Water Heaters, Section 2. Test Conditions, 2.5 Set Point Temperature.

⁵⁸ Unknown COP is the average of storage tank heat pump water heater’s COP for medium to high draw types covering a storage capacity range of 50 gallons to 80 gallons taken from California Energy Data and Reporting System’s DEER Water Heater Calculator [272].

- <https://www.ecfr.gov/current/title-10/chapter-II/subchapter-D/part-430/subpart-B>
- [274] Code of Federal Regulations. 2022. Review of Title 10, Chapter II, Subchapter D, Part 431. Appendix B to Subpart G of Part 431 - Uniform Test Method for the Measurement of Standby Loss of Electric Storage Water Heaters and Storage-Type Instantaneous Water Heaters, eCFR. December 1, 2022.
<https://www.ecfr.gov/current/title-10/chapter-II/subchapter-D/part-431/subpart-G>
- [275] New York Standard Approach for Estimating Energy Savings from Energy Efficiency Programs – Version 9 (New York State Joint Utilities, 2021), Pg 76.
[https://www3.dps.ny.gov/W/PSCWeb.nsf/96f0fec0b45a3c6485257688006a701a/72c23decff52920a85257f1100671bdd/\\$FILE/NYS%2OTRM%2OV9.pdf](https://www3.dps.ny.gov/W/PSCWeb.nsf/96f0fec0b45a3c6485257688006a701a/72c23decff52920a85257f1100671bdd/$FILE/NYS%2OTRM%2OV9.pdf)
- [276] New York Standard Approach for Estimating Energy Savings from Energy Efficiency Programs – Version 9. (New York State Joint Utilities, 2021), Pg 74.
[https://www3.dps.ny.gov/W/PSCWeb.nsf/96f0fec0b45a3c6485257688006a701a/72c23decff52920a85257f1100671bdd/\\$FILE/NYS%2OTRM%2OV9.pdf](https://www3.dps.ny.gov/W/PSCWeb.nsf/96f0fec0b45a3c6485257688006a701a/72c23decff52920a85257f1100671bdd/$FILE/NYS%2OTRM%2OV9.pdf)
- [277] NREL. 2022. Review of US Residential Sector circa 2018. ResStock. September 2022.
https://resstock.nrel.gov/dataviewer/building-characteristics/?datasetName=vizstock_resstock_amy2018_release_2022_1_by_state_view.
- [278] Code of Federal Regulations. 2022. Review of Title 10, Chapter II, Subchapter D, Part 430, Subpart C, 430.32 d) eCFR. November 28, 2022.
<https://www.ecfr.gov/current/title-10/chapter-II/subchapter-D/part-430/subpart-C/section-430.32>
- [279] Simulations of prototype buildings from NY TRM updated with NJ weather done by NJ Statewide Evaluator, May 2022
- [280] New York Standard Approach for Estimating Energy Savings from Energy Efficiency Programs – Version 9. (New York State Joint Utilities, 2021), Pg 509,
[https://www3.dps.ny.gov/W/PSCWeb.nsf/96f0fec0b45a3c6485257688006a701a/72c23decff52920a85257f1100671bdd/\\$FILE/NYS%2OTRM%2OV9.pdf](https://www3.dps.ny.gov/W/PSCWeb.nsf/96f0fec0b45a3c6485257688006a701a/72c23decff52920a85257f1100671bdd/$FILE/NYS%2OTRM%2OV9.pdf)
- [281] California Public Utilities Commission EUL Table, version 027 (updated November 12, 2022). Accessed December 30, 2022. <https://www.caetrm.com/shared-data/value-table/EUL/>

2.7.9 POOL PUMPS

Market	Residential/Multifamily
Baseline Condition	TOS/NC
Baseline	Code
End Use Subcategory	Swimming Pools
Measure Last Reviewed	December 2022

Description

This measure covers the installation of ENERGY STAR® certified variable frequency drive (VFD) pool pumps in residential buildings and multifamily buildings. An ENERGY STAR® certified pool pump can run at different speeds and be programmed to match the pool operation with its appropriate pool pump speed. The measure is applicable to normal replacement, new construction, or time of sale baseline conditions.

Baseline Case

The baseline case is a self-priming (aboveground) or non-self-priming (inground) pool filter pump with a minimum allowable weighted energy factor defined by the Code of Federal Regulations [282]. Starting July 19, 2021, all pool pumps must be rated according to Weighted Energy Factor (WEF), i.e., kilogallons of water pumped per unit kWh [283].

Efficient Case

The efficient case is an ENERGY STAR® version 3.1 qualified variable-speed self-priming (inground) or non-self-priming (aboveground) pool filter pump. The weighted energy factor of the efficient pump must be greater than or equal to the Energy Star WEF requirement set for a given hydraulic horsepower (HHP) class of pool pumps. The HHP is the overall pumping power that is available from the motor and is different than the shaft power. The HHP can be derived from the proposed ENERGY STAR® pump's spec sheet from the ENERGY STAR® Database [284].

Annual Energy Savings Algorithm

Annual Electric Energy Savings

$$\Delta kWh = units \times days \times V_{pool} \times N_{turnover} \times \left(\frac{1}{WEF_b} - \frac{1}{WEF_q} \right) / 1,000$$

Annual Fuel Savings

$$\Delta Therms = N/A$$

Peak Demand Savings

$$\Delta kW_{Peak} = \Delta kWh \times ETDF$$

Where,

$$ETDF = \frac{CF}{Hrs}$$

$$Hrs = Hrs_{daily} \times days$$

Daily Peak Fuel Savings

$$\Delta Therms_{Peak} = N/A$$

Lifetime Energy Savings Algorithms:

Lifetime Electric Energy Savings

$$\Delta kWh_{Life} = \Delta kWh \times EUL$$

Lifetime Fuel Savings

$$\Delta Therms_{Life} = N/A$$

Calculation Parameters

Table 2-192 Calculation Parameters

Variable	Description	Value	Units	Ref
ΔkWh	Annual electric energy savings	Calculated	kWh/yr	
ΔkW_{Peak}	Peak Demand Savings	Calculated	kW	
ΔkWh_{Life}	Lifetime electric energy savings	Calculated	kWh	
Hrs	Annual hours of operation	Calculated	hr	
units	Number of measures installed	Site-specific	N/A	
days	Number of days of operation of the pool pump annually	Site-specific, if unknown use 122	N/A	[285]
V_{pool}	Volume of pool	Site-specific, if unknown use 22,000 gallons (inground) 7,540 (above ground)	Gallons	[286][290]
$N_{turnover}$	Number of turnovers per day, where a turnover is a full cycling of pool water by the pump through the filter or the cleaner	Site-specific, if unknown use 2	N/A	[286]
WEF_b	Minimum allowable Federal Weighted Energy Factors	Look up in Table 2-193	kgal/kWh	[283][284]
WEF_q	Energy Efficient Pool Pumps Weighted Energy factor, per Energy Star certificate	Site-specific, min qualifying in Table 2-193	kgal/kWh	[283][284]
HHP	Hydraulic horsepower, per energy star certificate	Site-specific	hp	[284]

Variable	Description	Value	Units	Ref
Hrs _{daily}	Daily hours of pump operation	Site-specific, if unknown use 5.18	hrs	[287]
CF	Coincidence factor	Look up in Table 2-194	N/A	[288]
PDF	Peak day factor	Look up in Table 2-194	N/A	
EUL	Effective useful life	See Measure Life Section	Years	

Table 2-193 Minimum Allowable WEF Rating

Dedicated-Purpose Pool Pump Type	HHP Applicability	Motor Phase	Baseline WEF Score (kgal/kWh)	Qualifying WEF Score (kgal/kWh)
Self-priming pool filter pumps	$0.711 \text{ hp} \leq \text{hhp} < 2.5 \text{ hp}$	Single	$-2.30 \times \ln(\text{hhp}) + 6.59$	$-2.45 \times \ln(\text{hhp}) + 8.4$
Self-priming pool filter pumps	$0.13 \text{ hp} < \text{hhp} < 0.711 \text{ hp}$	Single	$-1.30 \times \ln(\text{hhp}) + 2.90$	$-2.45 \times \ln(\text{hhp}) + 8.4$
Self-priming pool filter pumps	$\text{hhp} \leq 0.13 \text{ hp}$	Single	5.55	13.4
Non-self-priming pool filter pumps	$0.13 \text{ hp} < \text{hhp} < 2.5 \text{ hp}$	Any	$-0.85 \times \ln(\text{hhp}) + 2.87$	$-1.00 \times \ln(\text{hhp}) + 3.85$
Non-self-priming pool filter pumps	$\text{hhp} \leq 0.13 \text{ hp}$	Any	4.60	4.92

Peak Factors

Table 2-194 Peak Factors

Peak Factor	Value	Ref
Electric coincidence factor (CF)	0.27	[288]
Natural gas peak day factor (PDF)	N/A	

Measure Life

The effective useful life (EUL) is 10 years [289].

References

- [282] Code of Federal Regulations. Review of Title 10, Chapter II, Subchapter D, Part 431, Subpart Y, 431.465 f). ECFR. September 19, 2022. <https://www.ecfr.gov/current/title-10/chapter-ii/subchapter-d/part-431/subpart-y>.
- [283] ENERGY STAR® Pool Pump ver 3.1 Final Specification Sheet. <https://www.energystar.gov/sites/default/files/asset/document/ENERGY%20STAR%20Version%203.1%20Pool%20Pumps%20Final%20Specification.pdf>
- [284] ENERGY STAR®, ENERGY STAR® Product Finder. <https://www.energystar.gov/productfinder/product/certified-pool-pumps>

- [285] CEE, Consortium for Energy Efficiency. 2013. Review of CEESM High Efficiency Residential Swimming Pool Initiative. Edited by Eileen Eaton. January 2013. https://library.cee1.org/system/files/library/9986/CEE_Res_SwimmingPoolInitiative_01Jan2013_Corrected.pdf
- [286] “Energy Star Pool Pump Calculator | Building America Solution Center.” n.d. Basc.pnnl.gov. Accessed December 1, 2022. <https://basc.pnnl.gov/library/energy-star-pool-pump-calculator>
- [287] “Mid-Atlantic Technical Reference Manual (TRM) V10 | Northeast Energy Efficiency Partnerships.” n.d. Neep.org. Accessed December 1, 2022. <https://neep.org/mid-atlantic-technical-reference-manual-trm-v10>
- [288] Design & Engineering Services, *INTEGRATION of DEMAND RESPONSE into TITLE 20 for RESIDENTIAL POOL PUMPS*. 2009. https://www.etcc-ca.com/sites/default/files/OLD/images/stories/dr_09.05.10_residentialpoolpumps_v7_10-0312.pdf.
- [289] DEER 2014 EUL ID: OutD-PoolPump
- [290] *Evaluation of Potential Best Management Practices – Pools, Spas, and Fountains*, (The California Urban Water Conservation Council, 2010) Pg 3. <https://calwep.org/wp-content/uploads/2021/03/Pools-Spas-and-Fountains-PBMP-2010.pdf>

2.8 WHOLE BUILDING

2.8.1 BEHAVIORAL CHANGE

Market	Residential/Multifamily
Baseline Condition	RF
Baseline	Existing
End Use Category	Whole Building
Measure Last Reviewed	January 2023

Description

This measure covers enrollment in a residential behavioral program that is designed to encourage lower energy usage through behavioral messaging. These behavioral messages can be periodic normative reports or messages that present the customers with timely information on their energy usage and a call to action to reduce or save energy. Behavioral messages can be delivered through many avenues, including paper, email, and text messages.

Because the characteristics of behavioral programs make them amenable to randomized, controlled trials, and because New Jersey is expected to regularly evaluate its behavioral energy efficiency programs, use of evaluated savings estimates is recommended. Evaluations should be conducted, and savings calculated in accordance with the NJ Evaluation Guidelines: Behavioral Program Process and Impact Evaluations, Prepared by NJ Statewide Evaluator (SWE).

References

NJ Evaluation Guidelines: Behavioral Program Process and Impact Evaluations, Prepared by NJ Statewide Evaluator (SWE). April 2023.

2.8.2 HOME PERFORMANCE WITH ENERGY STAR (HPWES)

Market	Residential/Multifamily
Baseline Condition	RF
Baseline	Existing
End Use Category	Whole Building
Measure Last Reviewed	January 2023

Description

This measure addresses whole building upgrades to residential and multifamily low-rise buildings compliant with the Home Performance with Energy Star (HPwES) version 1.5 requirements [291]. In order to implement Home Performance with ENERGY STAR, there are various standards, a program implementer must adhere to. The HPwES program implemented in NJ uses software that meets national standards for savings calculations from whole-house approaches such as home performance. The difference in modeled annual energy consumption between the program and existing home is the project savings for heating, hot water, cooling, lighting, and appliance end uses.

The software the program implementer uses must adhere to at least one of the following standards:

- A software tool whose performance has passed testing according to the National Renewable Energy Laboratory's HERS BESTEST software energy simulation testing protocol [292].
- Software approved by the US Department of Energy's Weatherization Assistance Program [293].
- RESNET approved rating software [294].

There are numerous software packages that comply with these standards. Some examples of the software packages are SnuggPro⁵⁹[295], REM/Rate, EnergyGauge and TREAT.

References

- [291] Home Performance with Energy Star (HPwES) version 1.5 requirements [Program Requirements | ENERGY STAR](#)
- [292] Information about BESTEST-EX can be found at <http://www.nrel.gov/buildings/bestest-ex.html>
- [293] A listing of software approved by US DOE available at <https://www.energy.gov/scep/wap/weatherization-energy-audits>
- [294] A listing of the approved RESNET software available at <https://www.resnet.us/providers/accredited-providers/hers-software-tools/>
- [295] SnuggPro software <https://snuggpro.com/>

⁵⁹ SnuggPro uses the OptiMiser energy modeling engine

2.8.3 NEW CONSTRUCTION

Market	Residential/Multifamily
Baseline Condition	NC
Baseline	Building Code
End Use Category	Whole Building
Measure Last Reviewed	January 2023

Description

This measure addresses high performance residential and multifamily new building design and construction. High performance new construction projects must satisfy the requirements for ENERGY STAR certification following either the Single-Family New Homes V3.1 program [296] or the Multifamily New Construction V1.1 program [297], US DOE Zero Energy Ready Home program [298], Passive House Institute US [299] or Passive House Institute [300].

High performance new construction projects in NJ shall estimate energy savings based on the difference in modeled annual energy consumption between the proposed new building design and a minimally code compliant building of equivalent area. Peak demand savings, if not reported by the software, should be calculated as a function of the energy savings as shown below:

$$kW = kWh \times \frac{CF}{EFLH_{cool}}$$

Where:

CF = cooling coincidence factor from Section 2.3.1

EFLH_{cool} = cooling equivalent full load hours from Section 2.3.1

Minimum energy performance requirements for all new construction projects are measured from IECC 2018/2021 or ASHRAE 90.1-2016/2019 energy code baselines, which is dictated by when the project permit was pulled. Modeling software requirements shall be dictated by the selected high performance new construction compliance program (i.e., those listed above). Energy and demand savings for measures included in the program but not modeled by the software should be calculated using the appropriate TRM measure section.

References

- [296] Energy Star V3.1 Single Family New Homes requirements
- [297] Energy Star V1.1 Multifamily New Construction requirements
- [298] DOE Zero Energy Ready Home (ZERH) Program requirements.
- [299] Passive House Institute US requirements
- [300] Passive House Institute requirements

3 COMMERCIAL & INDUSTRIAL

3.1 AGRICULTURE

3.1.1 AUTO MILKER TAKEOFF

Market	Commercial
Baseline Condition	RF
Baseline	Existing
End Use Subcategory	Equipment
Measure Last Reviewed	January 2023

Description

This section provides energy savings and demand savings algorithms for replacement of manual milker takeoffs with automatic milker takeoffs on dairy milking vacuum pump systems. Automatic milker takeoffs have flow sensors which help shut off the suction on teats once a minimum flow rate is achieved. This reduces the load on the vacuum pump.

Equipment with existing automatic milker takeoffs is not eligible. In addition, the vacuum pump system serving the impacted milking units must be equipped with a variable speed drive (VSD) to qualify for incentives. Without a VSD, little or no savings will be realized.

Baseline Case

Pre-existing manual takeoffs on constant speed dairy milking vacuum pump systems.

Efficient Case

Automatic milker takeoffs. Vacuum pump system serving the impacted milking units must be equipped with a variable speed drive (VSD).

Annual Energy Savings Algorithms

Annual Electric Energy Savings

$$\Delta kWh = N_{cows} \times \Delta ESC$$

Annual Fuel Savings

$$\Delta Therms = N/A$$

Peak Demand Savings

$$\Delta kW_{Peak} = \Delta kWh \times ETDF$$

Daily Peak Fuel Savings

$$\Delta Therms_{Peak} = N/A$$

Lifetime Energy Savings Algorithms

Lifetime Electric Energy Savings

$$\Delta kWh_{Life} = \Delta kWh \times EUL$$

Lifetime Fuel Savings

$$\Delta Therms_{Life} = N/A$$

Calculation Parameters

Table 3-1 Calculation Parameters

Variable	Description	Value	Units	Ref
ΔkWh	Annual electric energy savings	Calculated	kWh/yr	
ΔkW_{Peak}	Peak Demand Savings	Calculated	kW	
ΔkWh_{Life}	Lifetime electric energy savings	Calculated	kWh	
N_{cows}	Number of cows milked per day	Site specific	Cows	
ΔESC	Annual energy savings per cow	34 ⁶⁰	kWh/cow	[302][303][304][305]
ETDF	Energy to demand factor	0.00017	kW/kWh	[306]
CF	Electric coincidence factor	Look up in Table 3-2	N/A	
PDF	Gas peak demand factor	Look up in Table 3-2	N/A	
EUL	Effective useful life	See Measure Life Section	Years	

⁶⁰ Annual energy savings per cow was calculated based on the following assumptions.

- An average herd size of 102 cows [302]
- Typical dairy vacuum pump size of 10 HP per herd size [303]
- Average pump operating hours are estimated at 10 hours per day [304]
- A 12.5% Energy savings factor [305]

Peak Factors

Table 3-2 Peak Factors

Peak Factor	Value	Ref
Electric coincidence factor (CF)	N/A	
Natural gas peak day factor (PDF)	N/A	

Measure Life

The effective useful life (EUL) is 10 years [301].

References

- [301] Idaho Power Demand Side Management Report, Supplement 1. March 15, 2022.
<https://docs.idahopower.com/pdfs/EnergyEfficiency/Reports/2021%20Supplement%201.pdf>
- [302] Chuck Nicholson, Mark Stephenson, Andrew Novakovic, *Study to Support Growth and Competitiveness of the Pennsylvania Dairy Industry*, (2017) .
https://dairymarkets.org/PA/Growth_and_Competitiveness_Study_DRAFT_Final_Report_June_2018.pdf PA Values were assumed to be similar to NJ Values because of the States' close proximity.
- [303] Average dairy vacuum pump size was estimated based on the Minnesota Dairy Project literature.
- [304] Mark Mayer, David Kammel, *Dairy Modernization Works for Family Farms* (2008).
https://archives.joe.org/joe/2010october/pdf/JOE_v48_5rb7.pdf.
- [305] Public Utilities Commission of Pennsylvania, *Technical Reference Manual: Volume 3: Commercial and Industrial Measures (2019)*, Pg 298, <https://www.puc.pa.gov/filing-resources/issues-laws-regulations/act-129/technical-reference-manual/>
- [306] Regional Technical Forum (RTF) as part of the Northwest Power & Conservation Council, *Deemed Measures List. Agricultural: Variable Frequency Drives-Dairy, FY2012, V1.2*.
<https://rtf.nwcouncil.org/measure/dairy-milking-machines-vacuum-pump>

3.1.2 DAIRY PUMP VFD

Market	Commercial
Baseline Condition	NC/RF
Baseline	Code/Existing
End Use Subcategory	Control
Measure Last Reviewed	January 2023

Description

Milking vacuum systems consume large amounts of electricity on dairy farms. A conventional system runs a vacuum pump motor at full speed and a mechanical vacuum regulator creates an intentional air leak or “bleed” to regulate the system pressure regardless of the amount of milk being pumped. When the system requires a higher level of vacuum, the regulator closes and the vacuum level increases.

This measure modifies the milking vacuum system and installs a variable speed drive (VSD) to control the vacuum pump motor. The VSD controls the speed of the vacuum pump motor, slowing it down when the milking units are attached to the udders, reducing electrical power demand and saving electricity usage. A milking vacuum system controlled with a VSD consists of three main parts: a three - phase electric motor, a VSD unit, and a differential pressure transducer. The VSD modulates the vacuum pump motor speed based on the control signal from the differential pressure transducer. The baseline for this measure reflects a standard vacuum pump motor operating at constant speed. If the motor is being replaced as part of this measure, the “New Motor” efficiency in the Standard Motor Efficiency table below shall be used. Otherwise, the “Existing Motor” efficiency shall be used.

Baseline Case

The baseline condition is a constant speed dairy vacuum pump with a motor size between 2.5-10hp that is controlled with a mechanical vacuum regulator.

Efficient Case

The compliance condition is a dairy vacuum pump with a variable speed drive installed.

Annual Energy Savings Algorithms

Annual Electric Energy Savings

$$\Delta kWh = \left[\left(\frac{hp \times LF \times 0.746}{Eff} \right) - (0.05 \times 2 \times MU + 1.7729) \right] \times hrs$$

Annual Fuel Savings

$$\Delta Therms = N/A$$

Peak Demand Savings

$$\Delta kW_{Peak} = \left[\left(\frac{hp \times LF \times 0.746}{Eff} \right) - (0.05 \times 2 \times MU + 1.7729) \right] \times CF$$

Daily Peak Fuel Savings

$$\Delta Therms_{Peak} = N/A$$

Lifetime Energy Savings Algorithms

Lifetime Electric Energy Savings

$$\Delta kWh_{Life} = \Delta kWh \times EUL$$

Lifetime Fuel Savings

$$\Delta Therms_{Life} = N/A$$

Calculation Parameters

Table 3-3 Calculation Parameters

Variable	Description	Value	Units	Ref
ΔkWh	Annual electric energy savings	Calculated	kWh/yr	
ΔkW_{Peak}	Peak Demand Savings	Calculated	kW	
ΔkWh_{Life}	Lifetime electric energy savings	Calculated	kWh	
hp	Rated horsepower of vacuum pump motor	Site-specific (limited to 10hp or lesser)	hp	
MU	Number of milking units equipped with a vacuum pump and controlled by VSD	Site-specific, if unknown: 5 hp motor = 3 MU 7.5hp motor = 12 MU 10 hp motor = 22 MU	N/A	
LF	Average load factor for a constant speed vacuum pump	Site-specific, if unknown use 0.76	N/A	[307]
Eff	Rated pump motor efficiency	Site-specific, if unknown look up in Table 3-4	N/A	[308][309]
hrs	Annual hours of pump operation	Site-specific, if unknown use 4,380	hours	[310]
0.746	Conversion factor from kW to hp	0.746	kW/hp	
0.05	Regression coefficient for the average speed of a VSD and processed milk units	0.05	N/A	[313]
2	Air flow rate of milking unit	2	CFM	[313]

Variable	Description	Value	Units	Ref
1.7729	Regression constant for the average speed of a VSD and processed milk units	1.7729	N/A	[313]
CF	Electric coincidence factor	Look up in Table 3-5	N/A	
PDF	Gas peak demand factor	Look up in Table 3-5	N/A	
EUL	Effective useful life	See Measure Life	Years	

Table 3-4 Standard Motor Efficiency

Motor Classification	Size (hp)	Existing Motor	New Motor
Milk: Vacuum Pump with Adjustable Speed Drive Package – 5 HP	5	87.5%	89.5%
Milk: Vacuum Pump with Adjustable Speed Drive Package – 7.5 HP	7.5	88.5%	91.7%
Milk: Vacuum Pump with Adjustable Speed Drive Package – 10 HP	10	89.5%	91.7%

Peak Factors

Table 3-5 Peak Factors

Peak Factor	Value	Ref
Electric coincidence factor (CF)	0.4	[311]
Natural gas peak day factor (PDF)	N/A	

Measure Life

Table 3-6 Measure Life

Equipment	EUL	RUL	Ref
Dairy Pump VFD	15	5	[312]

References

- [307] Cascade Energy. “Proposed Standard Savings Estimation Protocol for Ultra-Premium Efficiency Motors.” Table 6: Load Factor by Nameplate hp and End Use. November 5, 2012. <https://nwcouncil.app.box.com/s/fkxkcwm1is88dnttb8ve7eb5rhs9ghmv>
- [308] The Energy Independence and Security Act of 2007 (EISA), 1800 RPM, TEFC assumed as typical for Dairy vacuum pump motors, see <https://www.govinfo.gov/content/pkg/PLAW-110publ140/pdf/PLAW-110publ140.pdf>
- [309] US Department of Energy, Office of Energy Efficiency & Renewable Energy, “Premium Efficiency Motor Selection and Application Guide: A Handbook for Industry”. Table 2-1. 1800 RPM, TEFC assumed as typical for

Dairy vacuum pump motors,

https://www.energy.gov/sites/prod/files/2014/04/f15/amo_motors_handbook_web.pdf

- [310] Assuming 2 milking and cleaning sessions per day, 5 hours per milking session, 1 hour per cleaning session, and 365 days of milking per year.
- [311] Regional Technical Forum (RTF) as part of the Northwest Power & Conservation Council, Deemed Measures List. Agricultural: Variable Frequency Drives-Dairy, FY2012, V1.2.
<https://rtf.nwcouncil.org/measure/dairy-milking-machines-vacuum-pump/>
- [312] California Public Utilities Commission EUL Table, version 027 (updated November 12, 2022). Accessed December 30, 2022. <https://www.caetrm.com/shared-data/value-table/EUL/>
- [313] Sanford, Scott (University of Wisconsin–Madison). “Milking System Air Consumption When Using a Variable Speed Vacuum Pump”, Figure 2. The regression coefficient of 0.0018 LPM is converted into 0.05 CFM. An air leakage rate of 2 CFM is chosen as a conservative estimate for which to perform regression analysis.

3.1.3 DAIRY REFRIGERATION TUNE UP

Market	Commercial
Baseline Condition	RF
Baseline	Existing
End Use Subcategory	Maintenance
Measure Last Reviewed	January 2023

Description

This section provides energy savings and demand savings algorithms for tune-ups on all refrigeration equipment in commercial-grade dairy settings with the intention being to reduce electrical consumption.

Baseline Case

Refrigeration equipment associated with a commercial-grade dairy farm facility that has not been inspected or tuned up in more than 12 months.

Efficient Case

The efficient condition is refrigeration equipment associated with a commercial-grade dairy farm facility that has been inspected and tuned up by a U.S. EPA 608 Certified Service Provider. The certified technician must abide by all rules and regulations related to refrigerant testing and safety protocol and must conduct the following tasks:

- Clean and inspect condenser and evaporator coils;
- Clean drain pan;
- Inspect/clean fans, screens, grills, filters, and drier cores;
- Inspect/adjust heat reclaim operation;
- Tighten all line voltage connections;
- Inspect/replace relays and capacitors as needed; and
- Add/remove refrigerant charge as needed.

Annual Energy Savings Algorithms

Annual Electric Energy Savings

$$\Delta kWh = \frac{N_{cows} \times lbs_{milk} \times C_{p,milk} \times \Delta T}{AEER \times 1,000} \times SF$$

Annual Fuel Savings

$$\Delta Therms = N/A$$

Peak Demand Savings

$$\Delta kW_{Peak} = N/A$$

Daily Peak Fuel Savings

$$\Delta Therms_{Peak} = N/A$$

Lifetime Energy Savings Algorithms

Lifetime Electric Energy Savings

$$\Delta kWh_{Life} = \Delta kWh \times EUL$$

Lifetime Fuel Savings

$$\Delta Therms_{Life} = N/A$$

Calculation Parameters

Table 3-7 Calculation Parameters

Variable	Description	Value	Units	Ref
ΔkWh	Annual electric energy savings	Calculated	kWh/yr	
ΔkWh_{Life}	Lifetime electric energy savings	Calculated	kWh	
N_{cows}	Number of cows	Site-specific	N/A	
lbs_{milk}	Average pounds of milk produced per cow per year	Site-specific, if unknown use 19,800	Lbs/yr	[314]
$C_{p,milk}$	Specific heating capacity of milk	0.94	Btu/lb-°F	[315]
ΔT	Difference in temperature between milk entering the bulk tank and final stored temperature of cooled milk	Look up in Table 3-8	°F	[316][317]
SF	Energy savings factor	0.05	N/A	[318]
AEER	Annual energy efficiency ratio of refrigeration compressor	15.39	Btu/watt-hr	[317]
1,000	Conversion from watts to kilowatts	1,000	W/kW	
CF	Electric coincidence factor	Look up in Table 3-9	N/A	
PDF	Gas peak demand factor	Look up in Table 3-9	N/A	
EUL	Effective useful life	See Measure Life Section	Years	

Table 3-8 Milk Temperature Differential (°F)

Type of cooling	Temperature (°F)
No pre-cooler used in operation	60
Pre-cooler used	30
Pre-cooler unit and VFD Pump are used	18.3

Peak Factors**Table 3-9 Peak Factors**

Peak Factor	Value	Ref
Electric coincidence factor (CF)	N/A	
Natural gas peak day factor (PDF)	N/A	

Measure Life

The effective useful life (EUL) is 1 year [317].

References

- [314] New Jersey Dept of Agriculture, 2021 Annual Report and Agricultural Statistics. (2021), page 21.
https://www.nass.usda.gov/Statistics_by_State/New_Jersey/Publications/Annual_Statistical_Bulletin/2021/2021_AnnualReportFinal.pdf
- [315] Hu, Jin & Sari, Osmani & Eicher, Sara & Rakotozanakajy, Rija, *Determination of specific heat of milk at different fat content between 1°C and 59°C using micro DSC*. (JOURNAL OF FOOD ENGINEERING,2009).
- [316] Scott Sanford, *Well water precoolers*. (Energy Conservation in Agriculture,2003), Pg 1,
<https://cdn.shopify.com/s/files/1/0145/8808/4272/files/A3784-03.pdf>
- [317] Sanford, Scott (University of Wisconsin–Madison). “Well Water Precoolers.” Publication A3784-3. October 2003. <http://learningstore.uwex.edu/Assets/pdfs/A3784-03.pdf>
- [318] *Best Management Practices for Dairy Farms* (Massachusetts Farm Energy Program, 2012), Pg 30,
<https://massfarmenergy.com/wp-content/uploads/2014/03/Dairy%20Farms%20Best%20Practices.pdf>

3.1.4 DAIRY SCROLL COMPRESSOR

Market	Commercial
Baseline Condition	RF
Baseline	Existing
End Use Subcategory	Equipment
Measure Last Reviewed	January 2023

Description

This measure covers the replacement of reciprocating compressors with scroll compressors in milk cooling dairy farm applications. A scroll compressor is a device used to compress refrigerant and is more efficient and reliable than traditional reciprocating compressors. Scroll compressors are now the predominant compressor type sold on the market in these applications; therefore, this measure is only applicable in retrofit scenarios. Lifecycle savings are calculated through the end of the remaining life of the existing compressor.

Baseline Case

The baseline condition for this measure is a dairy operation using a reciprocating compressor for milk cooling.

Efficient Case

The compliance condition is the replacement of a reciprocating compressor with a scroll compressor for milk cooling.

Annual Energy Savings Algorithms

Annual Electric Energy Savings

$$\Delta kWh = \frac{Btu/h_q}{Btu/h_{total}} \times lbs_{milk} \times cows \times \Delta T \times 0.93 \times \left[\left(\frac{1}{EER_b \times 1,000} \right) - \left(\frac{1}{EER_q \times 1,000} \right) \right]$$

Where,

$$EER_q = \frac{Btu/h_q}{W_q}$$

$$EER_b = \frac{Btu/h_b}{W_b}$$

If EER_b is unknown use

$$EER_b = 0.85 \times EER_q$$

Annual Fuel Savings

$$\Delta Therms = N/A$$

Peak Demand Savings

$$\Delta kW_{Peak} = \frac{\Delta kWh}{8,760} \times CF$$

Daily Peak Fuel Savings

$$\Delta Therms_{Peak} = N/A$$

Lifetime Energy Savings Algorithms

Lifetime Electric Energy Savings

$$\Delta kWh_{Life} = \Delta kWh \times EUL$$

Lifetime Fuel Savings

$$\Delta Therms_{Life} = N/A$$

Calculation Parameters

Table 3-10 Calculation Parameters

Variable	Description	Value	Units	Ref
ΔkWh	Annual electric energy savings	Calculated	kWh/yr	
ΔkW_{Peak}	Peak Demand Savings	Calculated	kW	
ΔkWh_{Life}	Lifetime electric energy savings	Calculated	kWh	
Btu/h_q	Nameplate Btu/h of installed scroll compressor	Site-specific	Btu/h	
Btu/h_{total}	Total cooling capacity of compressors on dairy farm	Site-specific	Btu/h	
Btu/h_b	Nameplate Btu/h of existing recip compressor	Site-specific	Btu/h	
lbs_{milk}	Average pounds of milk produced per cow per year	19,800	lb	[319]
cows	Number of milking cows on farm	Site-specific	N/A	
ΔT	Difference in temperature between the milk entering the bulk tank and final stored temperature of cooled milk	Look up in Table 3-11	(°F)	[320]
W_b	Nameplate wattage of existing reciprocating compressor	Site-specific	watts	
W_q	Nameplate wattage of installed scroll compressor	Site-specific	watts	

Variable	Description	Value	Units	Ref
EER _q	Energy efficiency ratio of scroll compressor based on nameplate Btu/h and wattage	Calculated	$\frac{\text{Btu/h}}{\text{watts}}$	[321]
EER _b	Energy efficiency ratio of reciprocating compressor based on nameplate Btu/h and wattage	Calculated	$\frac{\text{Btu/h}}{\text{watts}}$	[321]
0.93	Specific heat of milk	0.93	Btu/lb-°F	[322]
1,000	Conversion Factor kW to watts	1,000	Kw/watts	
8,760	Hours in one year	8,760	hours	
CF	Electric coincidence factor	Look up in Table 3-12	N/A	
PDF	Gas peak day factor	Look up in Table 3-12	N/A	
EUL	Effective useful life	See Measure Life Section	Years	

Table 3-11 Difference in temperature for various equipments

Equipment	ΔT
No Pre-Cooler	60
Standard Pre-Cooler	30
Variable Speed Pre-Cooler	18.3

Peak Factors

Table 3-12 Peak Factors

Peak Factor	Value	Ref
Electric coincidence factor (CF)	1	
Natural gas peak day factor (PDF)	N/A	

Measure Life

The effective useful life (EUL) is limited to the Remaining Useful Life (RUL) of the existing compressor with a default value of 4 years.

References

- [319] USDA, National Agricultural Statistics Service, *2021 Annual Report and Agricultural Statistics*, pg. 21.
https://www.nass.usda.gov/Statistics_by_State/New_Jersey/Publications/Annual_Statistical_Bulletin/2021/2021_AnnualReportFinal.pdf

- [320] Sanford, Scott (University of Wisconsin–Madison). *Energy Efficiency for Dairy Enterprises*. Presentation to Agricultural and Life Sciences Program staff. It was determined that a plate cooler alone can reduce milk temperature to 68 °F and a plate cooler paired with a milk transfer pump VSD can reduce milk temperature to 56.3 °F. The additional benefits of the milk transfer pump VSD over the plate cooler is 11.7 °F. Milk is stored at 38°F, therefore $56.3^{\circ}\text{F}-38^{\circ}\text{F}=18.3^{\circ}\text{F}$. December 2014.
<https://aeeibse.wp.prod.es.cloud.vt.edu/wp-content/uploads/2018/01/EC-for-Dairy-Enterprises-Nov-2017.pdf>
- [321] *Massachusetts Farm Energy Best Management Practices for Dairy Farms*, United States Department of Agriculture (USDA), Natural Resource Conservation Service (NRCS), 2012.
<https://massfarmenergy.com/wp-content/uploads/2014/03/Dairy%20Farms%20Best%20Practices.pdf>
- [322] 2018 ASHRAE Handbook – Refrigeration, Specific heat of whole milk, Table 3: Unfrozen Composition Data, Initial Freezing Point, and Specific Heat of Foods.

3.1.5 LIVESTOCK WATERER

Market	Commercial
Baseline Condition	EREP/TOS/NC
Baseline	Existing/ISP/Dual
End Use Subcategory	Equipment
Measure Last Reviewed	January 2023

Description

This measure covers the installation of energy-efficient livestock waterers. A livestock waterer provides clean drinking water for livestock. Regular livestock waterers employ the use of large electric resistance heaters to prevent water from freezing. Energy efficient livestock waterers use super insulation (insulation of at least 2 inches) to maintain water temperature above freezing temperature.

Baseline Case

Early replacement (EREP) of an existing livestock waterer: First baseline, for remaining useful life of existing equipment: Electrically heated livestock waterer with no insulation. Second baseline, for remainder of measure life: Industry standard practice (ISP).

Time of sale (TOS) of an existing livestock waterer: Industry standard practice (ISP).

Addition of a new (NC) livestock waterer: Industry standard practice (ISP).

Efficient Case

Energy efficient livestock watering system that is thermostatically controlled and has factory-installed insulation with a minimum thickness of 2 inches.

Annual Energy Savings Algorithms

Annual Electric Energy Savings

$$\Delta kWh = \frac{W_b - W_q}{1,000} \times hrs \times F_{runtime}$$

Annual Fuel Savings

$$\Delta Therms = N/A$$

Peak Demand Savings

$$\Delta kW_{Peak} = N/A$$

Daily Peak Fuel Savings

$$\Delta Therms_{Peak} = N/A$$

Lifetime Energy Savings Algorithms

Lifetime Electric Energy Savings

$$\Delta kWh_{Life} = \Delta kWh \times EUL$$

Lifetime Fuel Savings

$$\Delta Therms_{Life} = N/A$$

Lifetime Electric Energy Savings

$$\Delta kWh_{Life} = (\Delta kWh \text{ against existing baseline}) \times RUL + (\Delta kWh \text{ against ISP baseline}) \times (EUL - RUL)$$

Lifetime Fuel Savings

$$\Delta Therms_{Life} = N/A$$

Calculation Parameters

Table 3-13 Calculation Parameters

Variable	Description	Value	Units	Ref
ΔkWh	Annual electric energy savings	Calculated	kWh/yr	
ΔkWh_{Life}	Lifetime electric energy savings	Calculated	kWh	
W_b	Rated wattage of baseline livestock waterer heating element	Site-specific. If unknown: Existing: 1,100W ISP: 500W	Watts	[323]
W_q	Rated wattage of efficient livestock waterer heating element	Site-specific	Watts	
hrs	Annual hours of operation during the winter when temperature is below 32°F	Site-specific. If unknown, look up in Table 3-15	hrs	[324]
$F_{runtime}$	Fraction of heater runtime	0.8	N/A	[325]
CF	Electric coincidence factor	Look up in Table 3-15	N/A	
PDF	Gas peak day factor	Look up in Table 3-15	N/A	
EUL	Effective useful life	See Measure Life Section	Years	
RUL	Remaining useful life of existing unit	See Measure Life Section	Years	

Table 3-14 Annual operating hours

Climate Zone	Hours below 32°F
Northern	1337
Southern	1220
Coastal	583
Central	1069
Pine Barrens	1021

Peak Factors**Table 3-15 Peak Factors**

Peak Factor	Value	Ref
Electric coincidence factor (CF)	N/A	[327]
Natural gas peak day factor (PDF)	N/A	

Measure Life

The effective useful life (EUL) is 10 years [326]. For early replacement projects, if the remaining useful life (RUL) of the existing equipment is unknown, assume 1/3 of the EUL = 3.3 years.

References

- [323] *New York Standard for Estimating Energy Savings from Energy Efficiency Programs Version 10*. (New York State Joint Utilities, 2021), pg 385.
- [324] Based on TMY3 data for various climate zones in New Jersey.
- [325] The Regional Technical Forum (RTF) analyzed metered data from three baseline livestock waterers and found the average run time of electric resistance heaters in the waterers to be approximately 80% for average monthly temperatures similar to Pennsylvania climate zones. This run time factor accounts for warmer make-up water being introduced to the tank as livestock drinking occurs. *Dairy Milking Machines Vacuum Pump Variable Frequency Drive*. n.d. Rtf.nwcouncil.org. Accessed January 13, 2023. <https://rtf.nwcouncil.org/measure/dairy-milking-machines-vacuum-pump/>
- [326] State of Wisconsin, *Focus on Energy Evaluation, Business Program: Measure Life Study Final Report: Appendix B* (August 25, 2009). https://focusonenergy.com/sites/default/files/bpmeasurelifestudyfinal_evaluationreport.pdf
- [327] No demand savings are expected for this measure, as the energy savings occur during the winter months.

3.1.6 LOW PRESSURE IRRIGATION

Market	Commercial
Baseline Condition	RF
Baseline	Existing
End Use Subcategory	Control
Measure Last Reviewed	January 2023

Description

This section provides energy and demand savings algorithms for the installation of a low-pressure irrigation system, which reduces the amount of energy required to apply the same amount of water as a baseline system.

The amount of energy saved per acre is a factor of the number of nozzles, the amount of water applied, the actual reduction in operating pressure, the pumping plant efficiency, and sprinkler or micro irrigation system conversions made to the system.

This measure requires a minimum 50% decrease in irrigation pumping pressure through the installation of a low-pressure irrigation system in agriculture applications. Pressure reduction can be achieved in several ways, such as nozzle or valve replacement, sprinkler head replacement, alterations or retrofits to the pumping plant, or drip irrigation system installation. Pre and post retrofit pump pressure measurements are required.

Baseline Case

High-pressure irrigation system with a baseline pump pressure, must be measured and recorded prior to installing low-pressure irrigation equipment.

Efficient Case

Low-pressure irrigation system in agriculture applications with a minimum of 50% reduction in pumping pressure.

Annual Energy Savings Algorithms

Annual Electric Energy Savings

$$\Delta kWh = \frac{\{N_{acres} \times (PSI_b - PSI_q) \times GPM\}}{1,714 \times Eff_{motor}} \times \left(\frac{0.746 kW}{HP}\right) \times HRS$$

Annual Fuel Savings

$$\Delta Therms = N/A$$

Peak Demand Savings

$$\Delta kW_{Peak} = \Delta kWh \times ETRDF$$

Daily Peak Fuel Savings

$$\Delta Therms_{Peak} = N/A$$

Lifetime Energy Savings Algorithms

Lifetime Electric Energy Savings

$$\Delta kWh_{Life} = \Delta kWh \times EUL$$

Lifetime Fuel Savings

$$\Delta Therms_{Life} = N/A$$

Calculation Parameters

Table 3-16 Calculation Parameters

Variable	Description	Value	Units	Ref
ΔkWh	Annual electric energy savings	Calculated	kWh/yr	
ΔkW_{Peak}	Peak Demand Savings	Calculated	kW	
ΔkWh_{Life}	Lifetime electric energy savings	Calculated	kWh	
N_{acres}	Number of acres irrigated	Site-specific	Acres	
PSI_b	Baseline pump pressure, must be measured and recorded prior to installing low-pressure irrigation equipment	Site-specific	Pounds per square inch (psi)	
PSI_q	Installed pump pressure, must be measured and recorded after the installation of low-pressure irrigation equipment by the installer	Site-specific	Pounds per square inch (psi)	
GPM	Pump flow rate per acre	Site-specific	Gallons Per Minute (GPM) /acre	
HRS	Average irrigation hours per growing season	Site-specific	Hours	
Eff_{motor}	Pump motor efficiency	Site-specific, if unknown look up in Table 3-17	N/A	[328]
0.746	Conversion from kW to HP	0.746	kW/HP	
1,714	Constant used to calculate hydraulic horsepower for conversion between horsepower and pressure and flow	1,714	$PSI \times GPM / HP$	
EDTF	Energy to Demand Factor	0.0026	kW/kWh	[330] [331]
CF	Electric coincidence factor	Look up in Table 3-18	N/A	
PDF	Gas peak demand factor	Look up in Table 3-18	N/A	

Variable	Description	Value	Units	Ref
EUL	Effective useful life	See Measure Life Section	Years	

Table 3-17 Motor Baseline Efficiencies

Motor HP	Motor Nominal Full-Load Efficiencies (percent)					
	4 Pole (1800 RPM)		6 Pole (1200 RPM)		8 Pole (900 RPM)	
	Enclosed	Open	Enclosed	Open	Enclosed	Open
1	85.5	85.5	82.5	82.5	75.5	75.5
1.5	86.5	86.5	87.5	86.5	78.5	77.0
2	86.5	86.5	88.5	87.5	84.0	86.5
3	89.5	89.5	89.5	88.5	85.5	87.5
5	89.5	89.5	89.5	89.5	86.5	88.5
7.5	91.7	91.0	91.0	90.2	86.5	89.5
10	91.7	91.7	91.0	91.7	89.5	90.2
15	92.4	93.0	91.7	91.7	89.5	90.2
20	93.0	93.0	91.7	92.4	90.2	91.0
25	93.6	93.6	93.0	93.0	90.2	91.0
30	93.6	94.1	93.0	93.6	91.7	91.7
40	94.1	94.1	94.1	94.1	91.7	91.7
50	94.5	94.5	94.1	94.1	92.4	92.4
60	95.0	95.0	94.5	94.5	92.4	93.0
75	95.4	95.0	94.5	94.5	93.6	94.1
100	95.4	95.4	95.0	95.0	93.6	94.1
125	95.4	95.4	95.0	95.0	94.1	94.1
150	95.8	95.8	95.8	95.4	94.1	94.1
200	96.2	95.8	95.8	95.4	94.5	94.1

Peak Factors

Table 3-18 Peak Factors

Peak Factor	Value	Ref
Electric coincidence factor (CF)	N/A	
Natural gas peak day factor (PDF)	N/A	

Measure Life

The effective useful life (EUL) is 5 years [329].

References

- [328] *Energy Conservation Program: Energy Conservation Standards for Commercial and Industrial Electric Motors; Final Rule: 79 Federal Register 103* (2014) <https://www.gpo.gov/fdsys/pkg/FR-2014-05-29/html/2014-11201.htm>
- [329] California Public Utilities Commission Database for Energy Efficient Resources (DEER) EUL Support Table for 2020, <http://www.deeresources.com/files/DEER2020/download/SupportTable-EUL2020.xlsx> Accessed January 2023.
- [330] Kanagy, Pamela K., *Farm and Ranch Irrigation*. Pennsylvania Agricultural Statistics, 2009-2010. https://www.nass.usda.gov/Statistics_by_State/Pennsylvania/Publications/Annual_Statistical_Bulletin/2009_2010/fris.pdf. Accessed January 2023.
- [331] Irrigation Water Withdrawals, 2015 by the U.S. Geological Society. Table 7. <https://pubs.usgs.gov/circ/1441/circ1441.pdf>. Accessed January 2023.

3.1.7 VENTILATION FANS

Market	Commercial
Baseline Condition	TOS/NC/EREP
Baseline	Existing/Dual
End Use Subcategory	Equipment
Measure Last Reviewed	January 2023

Description

This measure is applicable to the installation of high speed, high efficiency fans and high-volume low speed (HVLS) fans installed in agricultural applications. For the purposes of this measure, a high speed fan shall consist of the blade and motor assembly. Ventilation, exhaust and circulating high speed fans improve animal comfort, control moisture and maintain indoor air quality for livestock and other agricultural applications. Variable frequency drives (VFD) may be installed along with high speed fans to increase energy savings and the associated savings are quantified by this methodology. If VFD savings are claimed via this measure, additional savings may not be claimed for VFDs utilizing a separate methodology. Qualifying fans must be rated by an Air Movement and Control Association (AMCA) accredited laboratory such as Bioenvironmental and Structural Systems (BESS) Laboratories.⁶¹

Baseline Case

The baseline condition for this measure is a standard efficiency exhaust, ventilation or circulating fan.

Efficient Case

The compliance condition for this measure is a high speed exhaust, ventilation, circulating, of HVLS fan that meets or exceeds the minimum efficiency requirements.

Annual Energy Savings Algorithms

Annual Electric Energy Savings

Exhaust and Ventilation Fans:

$$\Delta kWh = \left(\frac{\frac{CFM_b}{(CFM/W)_b} - \frac{CFM_q}{(CFM/W)_q} \times F_{VFD,q}}{1,000} \right) \times hrs$$

Internal circulation fans and HVLS fans:

⁶¹ BESS Laboratories is a research, product testing, and educational laboratory at the University of Illinois.

$$\Delta kWh = \left(\frac{lb f_b}{(lb f/kW)_b} - \frac{lb f_q}{(lb f/kW)_q} \times F_{VFD,q} \right) \times hrs$$

Annual Fuel Savings

$$\Delta Therms = N/A$$

Peak Demand Savings

$$\Delta kW_{Peak} = \frac{\Delta kWh}{hrs} \times CF$$

Daily Peak Fuel Savings

$$\Delta Therms_{Peak} = N/A$$

Lifetime Energy Savings Algorithms

Lifetime Electric Energy Savings

$$\Delta kWh_{Life} = \Delta kWh \times EUL$$

Lifetime Fuel Savings

$$\Delta Therms_{Life} = N/A$$

Dual:

Lifetime Electric Energy Savings

$$\Delta kWh_{Life} = \Delta kWh_{EREP} \times RUL + \Delta kWh_{NR} \times EUL$$

Lifetime Fuel Savings

$$\Delta Therms_{Life} = \Delta Therms_{EREP} \times RUL + \Delta Therms_{NR} \times EUL$$

Calculation Parameters

Table 3-19 Calculation Parameters

Variable	Description	Value	Units	Ref
ΔkWh	Annual electric energy savings	Calculated	kWh/yr	
ΔkW_{Peak}	Peak Demand Savings	Calculated	kW	
ΔkWh_{Life}	Lifetime electric energy savings	Calculated	kWh	
CFM_b	Cubic feet per minute of existing fan	Site-specific ⁶² , if unknown use CFM_q	Ft ³ /min	[335]

⁶² look up from BESS Labs database based on manufacturer and model number.

Variable	Description	Value	Units	Ref
CFM _q	Cubic feet per minute of installed fan	Site specific	Ft ³ /min	
(CFM/W) _q	Ventilating efficiency ratio of installed fan	Site-specific, if unknown look up in Table 3-20	CFM/W	
(lbf/kW) _q	Thrust efficiency ratio of installed fan	Site-specific, if unknown look up in Table 3-20	Lbf/kW	
(CFM/W) _b	Ventilating efficiency ratio of existing fan	Look up in Table 3-20	CFM/W	
(lbf/kW) _b	Thrust efficiency ratio of existing fan	Look up in Table 3-20	Lbf/kW	
lbf _b	Thrust of existing fan	Site specific ⁶³ , if unknown use lbf _q	Lbs/force	[335]
lbf _q	Thrust of installed fan	Site-specific	Lbs/force	
F _{VFD,q}	Reduced consumption resultant from VFD control	Look up in Table 3-21	N/A	[333]
Hrs	Operating hours	Look up in Table 3-22	Hours	
CF	Electric coincidence factor	Look up in Table 3-23	N/A	
PDF	Gas peak demand factor	Look up in Table 3-23	N/A	
EUL	Effective useful life	See Measure Life Section	Years	

Table 3-20 Baseline and Efficient Condition Efficiencies

Fan Diameter	Baseline ⁶⁴		Efficient ⁶⁵	
	Circulation, Ventilation and Exhaust Fans (CFM/W)	Circulating Fans (lbf/kW)	Circulation, Ventilation and Exhaust Fans (CFM/W)	Circulating Fans (lbf/kW)
24"-35"	9.4	10.5	14.0	15.0
36"-47"	12.2	12.9	17.0	20.0
48"-52"	15.1	19.8	19.9	24.2
53"+	16.7	20.8	22.0	24.6

Table 3-21 VFD Factor

Fan Application	Value
No VFD	1.00

⁶³ look up from BESS Labs database based on manufacturer and model number.

⁶⁴ Default baseline efficiency was determined by calculating the 10th percentile of the efficiencies of all fans in the active BESS Labs database for the respective fan diameter ranges. Many low efficiency fans are often not tested by BESS Labs, therefore the average tested fan is more efficient than the average market available fan. Ventilation and exhaust fan CFM and circulating fan lbf represent the averages of each diameter range, regardless of fan efficiency. The database includes single and three phase fans at four voltages.

⁶⁵ Minimum qualifying fan efficiency is equivalent to the 75th percentile of all BESS Labs tested in the respective fan diameters. The database includes single and three phase fans at four voltages

Fan Application	Value
Greenhouse	0.64
Poultry/Livestock	0.75

Table 3-22 Operating Hours

City	Circulating/HVLS Fan Hours ⁶⁶	Exhaust/Ventilation Fan Hours ⁶⁷
Northern	4,362	6,570
Southern	4,632	6,570
Coastal	5,017	6,570
Central	4,636	6,570
Pine Barrens	4,684	6,570

Peak Factors

Table 3-23 Peak Factors

Peak Factor	Value	Ref
Electric coincidence factor (CF)	1.0	[334]
Natural gas peak day factor (PDF)	N/A	

Measure Life

The remaining useful life (RUL) for existing equipment is limited to 1/3 of the effective useful life (EUL) of the equipment.

Table 3-24 Measure Life

Equipment	EUL	RUL	Ref
Ventilation Fans	15	5	[332]

References

- [332] California Public Utilities Commission Database for Energy Efficient Resources (DEER) EUL Support Table for 2020, <http://www.deeresources.com/files/DEER2020/download/SupportTable-EUL2020.xlsx>.

⁶⁶ Default hours are developed from NOAA hourly normals by summing annual hours dry bulb temperature is above 50°F; NOAA National Centers for Environmental information – NCEI 2010 Hourly Normals

⁶⁷ Exhaust/Ventilation fans are assumed to operate 75% of total annual hours (8,760 x 0.75 = 6,570)

- [333] Teitel, M. & Levi, Asher & Zhao, Yun & Barak, Moti & Bar-lev, Eli & Shmuel, David. (2008). Energy saving in agricultural buildings through fan motor control by variable frequency drives. *Energy and Buildings*. 40. 953-960. 10.1016/j.enbuild.2007.07.010
- [334] New York Standard Approach for Estimating Energy Savings from Energy Efficiency Programs – Residential, Multi-Family, and Commercial/Industrial Measures. January 1, 2023.
- [335] Circulating Fans, Bioenvironmental and Structural Systems Laboratory, University of Illinois, Department of Agricultural and Biological Engineering, Accessed January 12, 2023. Available from: <http://bess.illinois.edu/>

3.1.8 HEAT RECLAIMERS

Market	Commercial
Baseline Condition	RF
Baseline	Existing
End Use Subcategory	Equipment
Measure Last Reviewed	January 2023

Description

This measure covers the installation of a refrigeration heat recovery (RHR) system on bulk tank compressors on dairy farms. Heat recovery systems recover waste heat from bulk tank compressors used in milk cooling processes. This waste heat is used to pre-heat water before it is transferred to a water heater, thus reducing the load of the water heater. Hot water is used in various farm applications such as cleaning and livestock watering.

There are two methods of calculating savings. One is to calculate the amount of energy that can be recovered by the heat recovery system in the milk cooling process. This method is reflected in the ΔBTU_{milk} equation. The second method is to calculate the energy required to heat the water in the storage tank to the set point. This method is reflected in the ΔBTU_{hru} , equation. The smaller of the two shall be selected. If ΔBTU_{milk} is smaller than ΔBTU_{hru} , this implies that the energy recovered by the heat recovery system is not sufficient to fully heat the water to the setpoint, and therefore represents the upper limit of savings. If ΔBTU_{hru} is smaller than ΔBTU_{milk} this implies the energy required to heat the water to the setpoint is less than the energy that is recovered by the heat recovery system, and therefore represents the upper limit of savings.

Baseline Case

Baseline condition for this measure is a dairy farm without a heat recovery system to feed preheated water to the water heater.

Efficient Case

The efficient condition is a dairy farm with a heat recovery system to preheat water to the waterheater.

Annual Energy Savings Algorithms

Annual Electric Energy Savings

$$\Delta kWh = \frac{MIN[\Delta BTU_{milk} \text{ or } \Delta BTU_{hru}]}{3,412 \times E_{t,elec}}$$

Where,

$$\Delta BTU_{milk} = lbs_{milk} \times cows \times \Delta T_{milk} \times 0.93 \times ESF$$

$$\Delta BTU_{hru} = v_{hru} \times \Delta T_{water} \times 8.33 \times 365 \times cows$$

$$\Delta T_{\text{water}} = T_{\text{set}} - T_{\text{main}}$$

Annual Fuel Savings

$$\Delta \text{Therms} = \frac{\text{MIN}[\Delta \text{BTU}_{\text{milk}} \text{ or } \Delta \text{BTU}_{\text{hru}}]}{100,000 \times E_{t,\text{fuel}}}$$

Peak Demand Savings

$$\Delta kW_{\text{Peak}} = \frac{\Delta kWh}{\text{hrs}} \times CF$$

Daily Peak Fuel Savings

$$\Delta \text{Therms}_{\text{Peak}} = \Delta \text{Therms} \times PDF$$

Lifetime Energy Savings Algorithms

Lifetime Electric Energy Savings

$$\Delta kWh_{\text{Life}} = \Delta kWh \times EUL$$

Lifetime Fuel Savings

$$\Delta \text{Therms}_{\text{Life}} = \Delta \text{Therms} \times EUL$$

Calculation Parameters

Table 3-25 Calculation Parameters

Variable	Description	Value	Units	Ref
ΔkWh	Annual electric energy savings	Calculated	kWh/yr	
ΔTherms	Annual fuel savings	Calculated	Therms/yr	
ΔkW_{Peak}	Peak Demand Savings	Calculated	kW	
$\Delta \text{Therms}_{\text{Peak}}$	Daily peak fuel savings	Calculated	Therms/day	
ΔkWh_{Life}	Lifetime electric energy savings	Calculated	kWh	
$\Delta \text{Therms}_{\text{Life}}$	Lifetime fuel savings	Calculated	Therms	
$\Delta \text{BTU}_{\text{milk}}$	Recoverable energy from milk cooling process	Calculated	Btu	
$\Delta \text{BTU}_{\text{hru}}$	Required energy to heat water in the storage tank unit to set temperature	Calculated	Btu	
ΔT_{water}	Change in water temperature attributable to heat recovery system	Calculated	°F	
Lbs_{milk}	Average pounds of milk produced per cow per year	19,800	Lbs/yr	[336]
Cows	Average number of cows milked per day	Site-specific	cow/day	

Variable	Description	Value	Units	Ref
ΔT_{milk}	Difference in temperature between milk entering the bulk tank and final stored temperature of cooled milk	Look up in Table 3-26	°F	[338]
ESF	Energy Savings Factor	0.4	N/A	[339]
V_{hru}	Volume of hot water for washing and cleaning per day per cow, in gallons	Site specific, if unknown use 6.3gal/cow/day	Gal/cow/day	[340]
T_{set}	Expected temperature an RHR unit can pre-heat well water up to	Site-specific, if unknown look up in Table 3-27	°F	[339]
T_{main}	Water main inlet temperature	Look up in Table 3-28	°F	[341]
$E_{\text{t,elec}}$	Thermal efficiency of electric water heater	Site-specific, if unknown use 0.98	N/A	[343]
$E_{\text{t,fuel}}$	Thermal efficiency of fossil fuel water heater	Site-specific, if unknown use 0.8	N/A	[344]
Hrs	Hours per year	Site-specific, if unknown use 2,920	Hrs/yr	[342]
0.93	Specific heat of milk	0.93	BTU/lb °F	
8.33	Energy required to heat one gallon of water by one degree	8.33	BTU	
3,412	Conversion factor BTU to kWh	3,412	BTU/kWh	
100,000	Conversion factor BTUs to Therms	100,000	BTU/Therm	
CF	Electric coincidence factor	Look up in Table 3-29	N/A	
PDF	Gas peak day factor	Look up in Table 3-29	N/A	
EUL	Effective useful life	See Measure Life Section	Years	

Table 3-26 Difference in Milk Temperature (ΔT_{milk} °F)

No Pre-Cooler	Standard Pre-Cooler	Variable Speed Pre-Cooler
60 °F	30 °F	18.3 °F

Table 3-27 RHR Setpoint Temperature (T_{set})

Fully condensing RHR system	Desuperheater RHR condenser
130 °F	105 °F

Table 3-28 Cold Water Inlet Temperature (T_{main})

NJ Climate Region	Annual Average Outdoor Temperature (°F)	T_{main} (°F)
Northern	50.75	56.75

NJ Climate Region	Annual Average Outdoor Temperature (°F)	T _{main} (°F)
Southern	52.37	58.37
Coastal	54.29	60.29
Central	52.45	58.45
Pine Barrens	52.44	58.44

Peak Factors

Table 3-29 Peak Factors

Peak Factor	Value	Ref
Electric coincidence factor (CF)	0.8	N/A
Natural gas peak day factor (PDF)	See	

Measure Life

The effective useful life (EUL) is 14 years. [336]

References

- [336] California Public Utilities Commission Database for Energy Efficient Resources (DEER) EUL Support Table for 2020, <http://www.deeresources.com/files/DEER2020/download/SupportTable-EUL2020.xlsx>.
- [337] New Jersey Dept of Agriculture, *2021 Annual Report and Agricultural Statistics*. (2021), page 21. [2021AnnualReportFinal.pdf \(usda.gov\)](https://www.nj.gov/agriculture/2021AnnualReportFinal.pdf)
- [338] Sanford, Scott (University of Wisconsin–Madison). “Well Water Precoolers.” Publication A37843. October 2003. It was determined that a plate cooler alone can reduce milk temperature to 68 °F and a plate cooler paired with a milk transfer pump VSD can reduce milk temperature to 56.3 °F. The additional benefits of the milk transfer pump VSD over the plate cooler is 11.7 °F. Milk is stored at 38°F, therefore 56.3°F-38°F=18.3°F.
- [339] DeLaval. “Dairy Farm Energy Efficiency”. (April 20, 2011.) A heat recovery system can recover 20%-60% of the energy required in the milk cooling process.
- [340] “Water Use on Dairy Farms.” 2011. MSU Extension. 2011 https://www.canr.msu.edu/news/water_use_on_dairy_farms.
- [341] Burch, Jay, and Craig Christensen. n.d. “TOWARDS DEVELOPMENT of an ALGORITHM for MAINS WATER TEMPERATURE.” https://www.energystar.gov/ia/partners/prod_development/new_specs/downloads/water_heaters/AlgorithmForMainsWaterTemperature.pdf.
- [342] “Dairy Farm Energy Management Guide: California.” n.d. www.energy.wsu.edu. Accessed January 12, 2023. <https://www.energy.wsu.edu/EnergyLibrary/AgricultureMatters/CatalogItemDetail.aspx?id=429>.
- [343] 10 CFR 430 Subpart B Appendix E – Uniform Test Method for Measuring the Energy Consumption of Water Heaters: 6.3.2 *Recovery Efficiency*. [https://www.ecfr.gov/current/title-10/chapter-II/subchapter-D/part-430/subpart-B#p-Appendix-E-to-Subpart-B-of-Part-430\(6.\)\(6.3\)\(6.3.2\)](https://www.ecfr.gov/current/title-10/chapter-II/subchapter-D/part-430/subpart-B#p-Appendix-E-to-Subpart-B-of-Part-430(6.)(6.3)(6.3.2)).

[344] 10 CFR 431.110 (a) – Energy conservation standards and their effective dates.
<https://www.ecfr.gov/current/title-10/chapter-II/subchapter-D/part431/subpart-G/>

3.1.9 ENGINE BLOCK HEATER TIMER

Market	Commercial
Baseline Condition	RF
Baseline	Existing
End Use Subcategory	Control
Measure Last Reviewed	January 2023

Description

This section provides energy savings algorithms for the installation of timers used to control engine block heaters on existing farm equipment. Engine block heaters are generally used during cold weather to warm an engine prior to use. Block heaters without automation are typically plugged in throughout the night. Using timers allows the heater to come on at a preset time rather than being on throughout the night. There are no peak demand savings associated with this measure since it does not affect peak period usage.

Baseline Case

Engine block heater without a timer that is manually controlled.

Efficient Case

Engine block heater controlled by a timer.

Annual Energy Savings Algorithms

Annual Electric Energy Savings

$$\Delta kWh = \frac{W_{heater}}{1,000} \times (hrs_b - hrs_q) \times Days \times UF$$

Annual Fuel Savings

$$\Delta Therms = N/A$$

Peak Demand Savings

$$\Delta kW_{peak} = N/A$$

Daily Peak Fuel Savings

$$\Delta Therms_{peak} = N/A$$

Lifetime Energy Savings Algorithms

Lifetime Electric Energy Savings

$$\Delta kWh_{Life} = \Delta kWh \times EUL$$

Lifetime Fuel Savings

$$\Delta Therms_{Life} = N/A$$

Calculation Parameters

Table 3-30 Calculation Parameters

Variable	Description	Value	Units	Ref
ΔkWh	Annual electric energy savings	Calculated	kWh/yr	
ΔkWh_{Life}	Lifetime electric energy savings	Calculated	kWh	
W_{heater}	Wattage of engine block heater	Site-specific, if unknown use 1,300	W	[345]
hrs_b	Baseline hours of use per day	Site-specific, if unknown use 12	Hrs/day	[345]
hrs_q	Energy efficient hours of use per day	Site-specific, if unknown use 3	Hrs/day	[345]
Days	Days of use per year	Site-specific, if unknown use 65	Days/yr	[345]
UF	Usage Factor	Site-specific, if unknown use 0.97	N/A	[345]
CF	Electric coincidence factor	Look up in Table 3-31	N/A	
PDF	Gas peak demand factor	Look up in Table 3-31	N/A	
EUL	Effective useful life	See Measure Life Section	Years	

Peak Factors

Table 3-31 Peak Factors

Peak Factor	Value	Ref
Electric coincidence factor (CF)	N/A	
Natural gas peak day factor (PDF)	N/A	

Measure Life

The effective useful life (EUL) is 15 years [346].

References

[345] Wisconsin Focus on Energy 2018 Technical Reference Manual. Public Service Commission of Wisconsin. The Cadmus Group, Inc. 2018. Pg. 590.

https://www.focusonenergy.com/sites/default/files/TRM%202018%20Final%20Version%20Dec%202017_1.pdf

[346] Gutierrez, Alfredo. Circulating Block Heater. Prepared for the California Technical Forum.

http://static1.squarespace.com/static/53c96e16e4b003bdba4f4fee/t/556f7c9ee4b0b65c3515c80c/1433369758093/Circulating+Block+Heater+Presentation_ver+2.pdf

3.2 APPLIANCES

3.2.1 CLOTHES WASHER

Market	Commercial
Baseline Condition	TOS/NC
Baseline	Code
End Use Subcategory	Clothes Washer
Measure Last Reviewed	January 2023

Description

This measure relates to the purchase (time of sale) and installation of a commercial clothes washer (i.e., soft-mounted front-loading or soft-mounted top-loading clothes washer that is designed for use in applications in which the occupants of more than one household will be using the clothes washer, such as multifamily housing common areas and coin laundries) exceeding the ENERGY STAR minimum qualifying efficiency standards. The Modified Energy Factor (MEF) measures energy consumption of the total laundry cycle (washing and drying). It indicates how many cubic feet of laundry can be washed and dried with one kWh of electricity; the higher the number, the greater the efficiency. The Water Factor (WF) is the number of gallons needed for each cubic foot of laundry. A lower number indicates lower consumption and more efficient use of water. Rather than filling the tub with water, efficient wash cycles are achieved by spinning or flipping clothes through a stream of water. Efficient rinse cycles are achieved through high-pressure spraying instead of soaking clothes. Reduced dryer load represents additional energy savings associated with the thorough removal of water from the clothes in the washer. Clothes washers that have earned the ENERGY STAR® label use approximately 25% less energy and 33% less water than comparable non-qualified models

Baseline Case

The baseline efficiency is minimum efficiency defined in the Code of Federal Regulations at 10 CFR 431.156. Efficiency is defined by the Modified Energy Factor (MEF) that takes into account the energy and water required per clothes washer cycle, including energy required by the clothes dryer per clothes washer cycle.

Efficient Case

The efficient condition is a commercial clothes washer meeting the ENERGY STAR v. 8.1 efficiency criteria.

Annual Energy Savings Algorithms

Annual Electric Energy Savings

$$\Delta kWh = \Delta kWh_{washer} + \Delta kWh_{DHW} + \Delta kWh_{dryer}$$

Where,

$$\Delta kWh_{washer} = \Delta kWh_{unit} \times F_{washer}$$

$$\Delta kWh_{DHW} = \Delta kWh_{unit} \times F_{DHW} \times SF_{DHW,electric}$$

$$\Delta kWh_{dryer} = (\Delta kWh_{total} - \Delta kWh_{unit}) \times \frac{F_{loads}}{F_{dryer}} \times F_{dryer,mod} \times SF_{dryer,electric}$$

$$\Delta kWh_{unit} = (kWh_{unit,b} - kWh_{unit,q}) \times \frac{N_{cycles}}{N_{cycles,ref}}$$

$$\Delta kWh_{total} = Cap \times N_{cycles} \times \left(\frac{1}{MEF_b} - \frac{1}{MEF_q} \right)$$

Annual Fuel Savings

$$\Delta Therms = \Delta Therms_{DHW} + \Delta Therms_{dryer}$$

Where,

$$\Delta Therms_{DHW} = \Delta kWh_{unit} \times \frac{F_{DHW}}{Eff_{DHW}} \times SF_{DHW,ff} \times 0.03412$$

$$\Delta Therms_{dryer} = (\Delta kWh_{total} - \Delta kWh_{unit}) \times \frac{F_{loads}}{F_{dryer}} \times F_{dryer,mod} \times F_{dryer,corr} \times SF_{dryer,ff} \times 0.03412$$

$$\Delta kWh_{unit} = (kWh_{unit,b} - kWh_{unit,q}) \times \frac{N_{cycles}}{N_{cycles,ref}}$$

$$\Delta kWh_{total} = Cap \times N_{cycles} \times \left(\frac{1}{MEF_b} - \frac{1}{MEF_q} \right)$$

Peak Demand Savings

$$\Delta kW_{Peak} = \frac{\Delta kWh}{Hrs} \times CF$$

Daily Peak Fuel Savings

$$\Delta Therms_{Peak} = \Delta Therms \times PDF$$

Lifetime Energy Savings Algorithms

Lifetime Electric Energy Savings

$$\Delta kWh_{Life} = \Delta kWh \times EUL$$

Lifetime Fuel Savings

$$\Delta Therms_{Life} = \Delta Therms \times EUL$$

Calculation Parameters

Table 3-32 Calculation Parameters

Variable	Description	Value	Units	Ref
ΔkWh	Annual electric energy savings	Calculated	kWh/yr	
$\Delta kWh_{\text{washer}}$	Annual electric energy savings attributed to clothes washer operation	Calculated	kWh/yr	
ΔkWh_{DHW}	Annual electric energy savings attributed to water heating	Calculated	kWh/yr	
$\Delta kWh_{\text{dryer}}$	Annual electric energy savings attributed to dryer operation	Calculated	kWh/yr	
ΔkWh_{unit}	Annual electric energy savings of a unit exclusive of dryer operation	Calculated	kWh/yr	
$\Delta kWh_{\text{total}}$	Annual electric energy savings of a unit inclusive of dryer operation	Calculated	kWh/yr	
ΔTherms	Annual fuel savings	Calculated	Therms/yr	
$\Delta \text{Therms}_{\text{DHW}}$	Annual fuel savings attributed to water heating	Calculated	Therms/yr	
$\Delta \text{Therms}_{\text{dryer}}$	Annual fuel savings attributed to dryer operation	Calculated	Therms/yr	
ΔkW_{Peak}	Peak Demand Savings	Calculated	kW	
$\Delta \text{Therms}_{\text{Peak}}$	Daily peak fuel savings	Calculated	Therms/day	
ΔkWh_{Life}	Lifetime electric energy savings	Calculated	kWh	
$\Delta \text{Therms}_{\text{Life}}$	Lifetime fuel savings	Calculated	Therms	
ΔH_2O	Annual water savings	Calculated	Gal/yr	
Cap	Clothes washer capacity	Site-specific. If unknown, use 3.43	ft ³	[350]
N_{cycles}	Number of cycles per year	Site-specific. If unknown, look up in Table 3-35	cycles	[347]
$kWh_{\text{unit,b}}$	Baseline rated unit electricity consumption	Site-specific. If unknown, use 241	kWh/yr	[347]
$kWh_{\text{unit,q}}$	Efficient rated unit electricity consumption	Site-specific. If unknown, use 97	kWh/yr	[347]
F_{washer}	Fraction of energy consumption attributed to clothes washer operation	Site-specific. If unknown, assume 0.20	N/A	[347]
F_{DHW}	Fraction of energy consumption attributed to water heating	Site-specific. If unknown, assume 0.80	N/A	[347]
F_{loads}	Fraction of washer loads dried in machine	Site-specific. If unknown, use 1.0	N/A	

Variable	Description	Value	Units	Ref
Eff_{DHW}	Fuel water heater efficiency	Site-specific. If unknown, use 0.75	N/A	
WF_q	Water factor for efficient unit	Site-specific. If unknown, look up in Table 3-36	Gal/(cycle-ft ³)	[350][351]
MEF_b	Modified Energy Factor of baseline unit	Look up in Table 3-33	N/A	[350][351]
MEF_q	Modified Energy Factor of efficient unit	Look up in Table 3-33	N/A	[350][351]
$SF_{DHW,electric}$	Electric DHW savings factor	Look up in Table 3-34	N/A	
$SF_{dryer,electric}$	Electric dryer savings factor	Look up in Table 3-34	N/A	
$SF_{DHW,ff}$	Fossil fuel DHW savings factor	Look up in Table 3-34	N/A	
$SF_{dryer,ff}$	Fossil fuel dryer savings factor	Look up in Table 3-34	N/A	
WF_b	Water factor for baseline unit	Look up in Table 3-36	Gal/(cycle-ft ³)	[350][351]
CF	Electric coincidence factor	Look up in Table 3-37	N/A	[347]
PDF	Gas peak day factor	Look up in Table 3-37	N/A	
Hrs	Annual operating hours	265	Hrs/yr	[347]
$N_{cycles,ref}$	Reference number of cycles per year	392	cycles	[347]
F_{dryer}	Dryer usage factor	0.84	N/A	[347]
$F_{dryer,mod}$	Dryer usage factor in buildings with dryer and washer	0.95	N/A	[347]
$F_{dryer,corr}$	Fossil fuel dryer correction factor	1.12	N/A	[347]
0.03412	Unit conversion, therm/kWh	0.03412	Therm/kWh	
EUL	Effective useful life	See Measure Life Section	Years	

Table 3-33 Modified Energy Factor of Baseline and Efficient Unit

Efficiency Level	Front Loading	Top Loading
Federal Standard	Before January 1, 2018	
	2.00	1.60
	On or After January 1, 2018	
	2.00	1.35
ENERGY STAR	2.20	

Table 3-34 DHW and Dryer Savings Factors

Fuel	SF _{DHW,electric}	SF _{dryer,electric}	SF _{DHW,ff}	SF _{dryer,ff}
Electric	1.00	1.00	0	0
Fossil Fuel	0	0	1.00	1.00

Table 3-35 Annual Cycles

Type	Number of Cycles
Multifamily Common Area	1,241
Laundromats	2,190

Table 3-36 Water Factor of Baseline and Efficient Unit

Efficiency Level	Front Loading	Top Loading
Federal Standard	Before January 1, 2018	
	5.5	8.5
	On or After January 1, 2018	
	4.1	8.8
ENERGY STAR	4.0	

Peak Factors

Table 3-37 Peak Factors

Peak Factor	Value	Ref
Electric coincidence factor (CF)	0.029	[347]
Natural gas peak day factor (PDF)	See Appendix G: Natural Gas Peak Day Factors	

Non-Energy Impacts

$$\Delta H2O = Cap \times (WF_b - WF_q) \times N_{cycles}$$

Measure Life

The effective useful life (EUL) for a multifamily common area is 11.3 years. The EUL for laundromats is 7.1 years. [347]

References

- [347] Regulations.gov, Energy Conservation Program: Energy Conservation Standards for Commercial Clothes Washers; Final Rule (2014). <https://www.regulations.gov/document/EERE-2012-BT-STD-0020-0037>
- [348] Metered data from Navigant Consulting, *EmPOWER Maryland Draft Final Evaluation Report Evaluation Year 4 (June 1, 2012 – May 31, 2013) Appliance Rebate Program*. March 21, 2014, page 36. This data applies to residential applications. In the absence of metered data specific to multifamily common area and commercial laundromat applications, this coincidence value is used as a proxy given consistency with the PJM peak definition; however, this value is likely conservatively low for commercial applications and is a candidate for update should more applicable data become available .
- [349] Clothes Washer Calculations for the ENERGY STAR Appliance Calculator. 2022. https://www.sfwmd.gov/sites/default/files/documents/calculator_energy_star_res_appliance_savings.xlsx.
- [350] Based on the average commercial clothes washer volume of all units meeting ENERGY STAR V8.1 criteria listed in the ENERGY STAR database of certified products accessed on 03/07/2016. <https://www.energystar.gov/sites/default/files/ENERGY%20STAR%20Version%208.1%20Clothes%20Washer%20Final%20Specification%20-%20Partner%20Commitments%20and%20Eligibility%20Criteria.pdf>
- [351] Office of Energy Efficiency and Renewable Energy, Department of Energy, Energy Conservation Program: Energy Conservation Standards for Commercial Clothes Washers. <https://www.federalregister.gov/documents/2021/12/20/2021-27461/energy-conservation-program-energy-conservation-standards-for-commercial-clothes-washers>

3.2.2 CLOTHES DRYERS

Market	Commercial
Baseline Condition	TOS
Baseline	Code
End Use Subcategory	Clothes Washer
Measure Last Reviewed	January 2023

Description

This measure covers residential grade clothes dryers meeting the criteria established under the ENERGY STAR® Program, Version 1.1, effective May 5, 2017, installed in small commercial settings. ENERGY STAR® clothes dryers have a higher combined energy factor (CEF), and save energy through a combination of more efficient drying and reduced runtime of the drying cycle. More efficient drying is achieved through increased insulation, modifying operating conditions, improving air circulation, and improved efficiency of motors. Reduced dryer runtime is achieved through automatic termination of the dryer cycles based on temperature and moisture sensors. Clothes dryers originally qualified for the ENERGY STAR® label in May 2014. Clothes dryers that have earned this label are approximately 20% more efficient than non-qualified models.

Baseline Case

The baseline for energy savings calculations is a clothes dryer meeting the federal minimum combined energy factor for machines manufactured after January 2015. The minimum combined energy factor varies by clothes dryer type.

Efficient Case

A clothes dryer that is an ENERGY STAR® version 1.1 qualifying model.

Annual Energy Savings Algorithms

Annual Electric Energy Savings

$$\Delta kWh = Cycles_{annual} \times Load \times \left(\frac{F_{elec,b}}{CEF_b} - \frac{F_{elec,q}}{CEF_q} \right)$$

Annual Fuel Savings

$$\Delta Therms = Cycles_{annual} \times Load \times \left(\frac{F_{fuel,b}}{CEF_b} - \frac{F_{fuel,q}}{CEF_q} \right) \times \frac{3,412}{100,000}$$

Peak Demand Savings

$$\Delta kW_{Peak} = \frac{\Delta kWh}{Hrs} \times CF$$

Daily Peak Fuel Savings

$$\Delta Therms_{Peak} = \Delta Therms \times PDF$$

Lifetime Energy Savings Algorithms

Lifetime Electric Energy Savings

$$\Delta kWh_{Life} = \Delta kWh \times EUL$$

Lifetime Fuel Savings

$$\Delta Therms_{Life} = \Delta Therms \times EUL$$

Calculation Parameters

Table 3-38 Calculation Parameters

Variable	Description	Value	Units	Ref
ΔkWh	Annual electric energy savings	Calculated	kWh/yr	
$\Delta Therms$	Annual fuel savings	Calculated	Therms/yr	
ΔkW_{Peak}	Peak Demand Savings	Calculated	kW	
$\Delta Therms_{Peak}$	Daily peak fuel savings	Calculated	Therms/day	
ΔkWh_{Life}	Lifetime electric energy savings	Calculated	kWh	
$\Delta Therms_{Life}$	Lifetime fuel savings	Calculated	Therms	
$Cycles_{Annual}$	Number of dryer cycles per year	Site-specific. If unknown, look up in Table 3-40	Cycles	[352]
Load	Average total weight of clothes per drying cycle	Look up in Table 3-39	lbs	[352]
$F_{elec,b}$	Percentage of energy consumed that is derived from electricity for baseline dryer	Look up in Table 3-39	%	[358][359]
$F_{elec,q}$	Percentage of energy consumed that is derived from electricity for efficient dryer	Look up in Table 3-39	%	[358][359]
$F_{fuel,b}$	Percentage of energy consumed that is derived from fossil fuel for baseline dryer	Look up in Table 3-39	%	[358][359]
$F_{fuel,q}$	Percentage of energy consumed that is derived from fossil fuel for efficient dryer	Look up in Table 3-39	%	[358][359]
CEF_b	Combined energy factor for baseline dryer	Look up in Table 3-39	lb/kWh	[354]
CEF_q	Combined energy factor for efficient dryer	Look up in Table 3-39	lb/kWh	[353]
Hrs	Annual run hours of clothes dryer	Site-specific. If unknown look up in Table 3-40	Hrs/yr	[352][357]
CF	Electric coincidence factor	Look up in Table 3-41	N/A	[355]

Variable	Description	Value	Units	Ref
PDF	Gas peak day factor	Look up in Table 3-41	N/A	
EUL	Effective useful life	See Measure Life Section	Years	

Table 3-39 Clothes Dryer Values

Variable	Vented Gas Dryer	Ventless or Vented Electric, Standard $\geq 4.4 \text{ ft}^3$	Ventless or Vented Electric, Compact (120V) $< 4.4 \text{ ft}^3$	Vented Electric, Compact (240V) $< 4.4 \text{ ft}^3$	Ventless Electric, Compact (240V) $< 4.4 \text{ ft}^3$
Load	8.45	8.45	3.00	3.00	3.00
$F_{elec,b}$	0.16 ⁶⁸	1.00	1.00	1.00	1.00
$F_{elec,q}$	0.16	1.00	1.00	1.00	1.00
$F_{fuel,b}$	0.84 ⁶⁹	0.00	0.00	0.00	0.00
$F_{fuel,q}$	0.84	0.00	0.00	0.00	0.00
CEF_b	3.30	3.73	3.61	3.27	2.55
CEF_q	3.48	3.93	3.80	3.45	2.68
Energy Star Most Efficient CEF_q		4.3	4.3	4.3	3.7

Table 3-40 Annual Dryer Cycles

Facility Type	Commercial – Multifamily	Laundromat
$Cycles_{Annual}$	1241	2190
Hrs ⁷⁰	1158	2044

⁶⁸ %Electric accounts for the fact that some of the savings on gas dryers comes from electricity (motors, controls, etc). 16% was determined using a ratio of the electric to total savings from gas dryers given by ENERGY STAR Draft 2 Version 1.0 Clothes Dryers Data and Analysis.

⁶⁹ %Gas accounts for the fact that some of the savings on gas dryers comes from electricity (motors, controls, etc). 84% was determined using a ratio of the gas to total savings from gas dryers given by ENERGY STAR Draft 2 Version 1.0 Clothes Dryers Data and Analysis.

⁷⁰ Assumes average of 56 minutes per cycle based on Ecova, 'Dryer Field Study', Northwest Energy Efficiency Alliance (NEEA) 2014.

Peak Factors

Table 3-41 Peak Factors

Peak Factor	Value	Ref
Electric coincidence factor (CF)	0.029	[355]
Natural gas peak day factor (PDF)	See Appendix G: Natural Gas Peak Day Factors	

Measure Life

The effective useful life (EUL) is 12 years [356].

References

- [352] Savings Calculator for ENERGY STAR Qualified Appliances, ENERGY STAR, 2012.
https://www.sfwmd.gov/sites/default/files/documents/calculator_energy_star_res_appliance_savings.xlsx
- [353] ENERGY STAR Program Requirements for Clothes Dryers -Partner Commitments Criteria ENERGY STAR® Program Requirements Product Specification for Clothes Dryers Partner Commitments. n.d.
https://www.energystar.gov/sites/default/files/ENERGY%20STAR%20Final%20Version%201.1%20Clothes%20Dryers%20Specification%20-%20Program%20Commitment%20Criteria%20and%20Eligibility%20Criteria_0.pdf
- [354] PART 430 - ENERGY CONSERVATION PROGRAM FOR CONSUMER PRODUCTS n.d.
<https://federalregister.gov>. <https://www.ecfr.gov/current/title-10/chapter-II/subchapter-D/part-430#430.32>
- [355] Mid-Atlantic Technical Reference Manual (TRM) V10. (2020), <https://neep.org/sites/default/files/media-files/trmv10.pdf>
- [356] California Public Utilities Commission Database for Energy Efficient Resources (DEER) EUL Support Table for 2020, <http://www.deeresources.com/files/DEER2020/download/SupportTable-EUL2020.xlsx>
- [357] Northwest Energy Efficiency Alliance (NEEA), 'Dryer Field Study', November 2014 https://ecotope-publications-database.ecotope.com/2014_005_1_DryerStudy.pdf
- [358] Mid-Atlantic Technical Reference Manual (TRM) V10 (2020). <https://neep.org/sites/default/files/media-files/trmv10.pdf>
- [359] ENERGY STAR Draft 2 Version 1.0 Clothes Dryers Data and Analysis, August 2013.
<https://www.energystar.gov/sites/default/files/specs/ENERGY%20STAR%20Draft%202%20Version%201.0%20Clothes%20Dryers%20Data%20and%20Analysis.xlsx>

3.2.3 CLOTHES DRYER MODULATING VALVE

Market	Commercial
Baseline Condition	RF
Baseline	Existing
End Use Subcategory	Clothes Washer
Measure Last Reviewed	January 2023

Description

This measure relates to the installation of a two-stage modulating gas valve retrofit kit on a standard commercial non-modulating gas dryer. Commercial gas clothes dryers found in coin-operated laundromats or on-premise laundromats (hospitals, hotels, health clubs, etc.) traditionally have a single firing rate which is sized properly for highest heat required in initial drying stages but is oversized for later drying stages requiring lesser heat. This causes the burner to cycle on/off frequently, resulting in less efficient drying and wasted gas. Replacing the single stage gas valve with a two-stage gas valve allows the firing rate to adjust to the changing heat demand, thereby reducing overall gas consumption.

Accurately estimating dryer energy consumption is complicated and challenging due to a variety of factors that influence cycle times and characteristics and ultimately drying energy requirements. Clothing loads can vary by weight, volume, fiber composition, physical structure, and initial water content, meaning that drying energy requirements can differ for any given cycle. Additionally, dryer settings selected by the user and interactions with the site's HVAC systems are known to influence dryer performance. As better information becomes available, this characterization can be modified to allow for a more site-specific estimation of savings.

Baseline Case

A 30- to 250- pound capacity commercial gas dryer with no modulating capabilities.

Efficient Case

A 30- to 250-pound capacity commercial gas dryer retrofitted with a two-stage modulating gas valve kit.

Annual Energy Savings Algorithms

Annual Electric Energy Savings

$$\Delta kWh = N/A$$

Annual Fuel Savings

$$\Delta Therms = N_{Cycles} \times SF$$

Peak Demand Savings

$$\Delta kW_{Peak} = N/A$$

Daily Peak Fuel Savings

$$\Delta Therms_{Peak} = \Delta Therms \times PDF$$

Lifetime Energy Savings Algorithms

Lifetime Electric Energy Savings

$$\Delta kWh_{Life} = N/A$$

Lifetime Fuel Savings

$$\Delta Therms_{Life} = \Delta Therms \times EUL$$

Calculation Parameters

Table 3-42 Calculation Parameters

Variable	Description	Value	Units	Ref
$\Delta Therms$	Annual fuel savings	Calculated	Therms/yr	
$\Delta Therms_{Peak}$	Daily peak fuel savings	Calculated	Therms/day	
$\Delta Therms_{Life}$	Lifetime fuel savings	Calculated	Therms	
N_{Cycles}	Number of dryer cycles per year	Site-specific. If unknown, look up in Table 3-43	Cycles/yr	[360]
SF	Savings factor	0.18	Therms/cycle	[361][360]
PDF	Gas peak day factor	Look up in Table 3-44	N/A	
EUL	Effective useful life	See Measure Life Section	Years	

Table 3-43 Estimated Dryer Cycles per Year

Application	Cycles per Year
Coin-Operated Laundromats	1,483
Multifamily Dryers	1,074
On-Premise Laundromats	3,607

Peak Factors

Table 3-44 Peak Factors

Peak Factor	Value	Ref
Electric coincidence factor (CF)	N/A	
Natural gas peak day factor (PDF)	See Appendix G: Natural Gas Peak Day Factors	

Measure Life

The effective useful life (EUL) is equal to 10 years[360].

References

[360] *IL 2022 Illinois Statewide Technical Reference Manual for Energy Efficiency : Version 10 (2022)*, Pg 734.
https://www.ilsag.info/wp-content/uploads/IL-TRM_Effective_010122_v10.0_Vol_2_C_and_I_09242021.pdf

[361] IL TRM v10, pg 734. Based on Illinois weather data, and average dryer performance for laundromat (30 to 45lb) and hotel (75 to 170 lb) dryers.

3.2.4 REFRIGERATORS

Market	Commercial
Baseline Condition	TOS/NC/EREP/DI
Baseline	Code/ISP/ Dual
End Use Subcategory	Kitchen
Measure Last Reviewed	January 2023

Description

This measure includes the installation of ENERGY STAR® compliant commercial refrigerators with an integral compressor and condenser. This measure is only applicable to horizontal or vertical self-contained refrigerators with solid or transparent doors.

Baseline Case

Early Replacement: The baseline condition for the Early Replacement measure is the existing commercial refrigerator for the remaining useful life of the unit, and then for the remainder of the measure life the baseline becomes a new replacement unit meeting the minimum federal efficiency standard.

Normal Replacement or Time of Sale: The baseline condition is a standard-efficiency commercial refrigerator meeting, but not exceeding, federal energy efficiency standards.

Efficient Case

The efficient condition is a high-efficiency packaged commercial refrigerator meeting ENERGY STAR® Version 5.0 requirements.

Annual Electric Energy Savings

Normal replacement or TOS (compared to code baseline):

$$\Delta kWh_{NR} = (kWh_b - kWh_q) \times (1 + HVAC_c) \times Days$$

Early replacement (compared to existing equipment):

$$\Delta kWh_{EREP} = (kWh_{ex} - kWh_q) \times (1 + HVAC_c) \times Days$$

Annual Fuel Savings

Normal replacement or TOS (compared to code baseline):

$$\Delta Therms_{NR} = (kWh_b - kWh_q) \times HVAC_{ff} \times 10 \times Days$$

Early replacement (compared to existing equipment):

$$\Delta Therms_{EREP} = (kWh_{ex} - kWh_q) \times HVAC_{ff} \times 10 \times Days$$

Peak Demand Savings

Normal replacement or TOS (compared to code baseline):

$$\Delta kW_{Peak,NR} = \left(\frac{kWh_b - kWh_q}{Daily\ Hours} \right) \times (1 + HVAC_d) \times CF$$

Early replacement (compared to existing equipment):

$$\Delta kW_{Peak,EREP} = \left(\frac{kWh_{ex} - kWh_q}{Daily\ Hours} \right) \times (1 + HVAC_d) \times CF$$

Daily Peak Fuel Savings

$$\Delta Therms_{Peak} = \Delta Therms \times PDF$$

Lifetime Energy Savings Algorithms

Normal replacement or TOS (compared to code baseline):

Lifetime Electric Energy Savings

$$\Delta kWh_{Life} = \Delta kWh \times EUL$$

Lifetime Fuel Savings

$$\Delta Therms_{Life} = \Delta Therms \times EUL$$

Early replacement (compared to existing equipment):

Lifetime Electric Energy Savings

$$\Delta kWh_{Life} = \Delta kWh_{EREP} \times RUL + \Delta kWh_{NR} \times (EUL - RUL)$$

Lifetime Fuel Savings

$$\Delta Therms_{Life} = \Delta Therms_{EREP} \times RUL + \Delta Therms_{NR} \times (EUL - RUL)$$

Calculation Parameters

Table 3-45 Calculation Parameters

Variable	Description	Value	Units	Ref
ΔkWh_{EREP}	Annual electric savings compared to existing unit	Calculated	kWh/yr	
ΔkWh_{NR}	Annual electric savings compared to code baseline	Calculated	kWh/yr	

Variable	Description	Value	Units	Ref
$\Delta Therm_{SEREP}$	Annual fuel savings compared to existing unit	Calculated	Therms/yr	
$\Delta Therm_{SNR}$	Annual fuel savings compared to code baseline	Calculated	Therms/yr	
$\Delta kW_{Peak,EREP}$	Peak Demand Savings compared to existing unit	Calculated	kW	
$\Delta kW_{Peak,NR}$	Peak Demand Savings compared to code baseline	Calculated	kW	
$\Delta Therm_{S_{Peak}}$	Daily peak fuel savings	Calculated	Therms/day	
ΔkWh_{Life}	Lifetime electric energy savings	Calculated	kWh	
$\Delta Therm_{Life}$	Lifetime fuel savings	Calculated	Therms	
V	Refrigerator volume	Site-specific	ft ³	
Days	Number of days of operations in a year	Site-specific. If unknown, use 365 days	days	
Daily Hours	Hours of operation in a day	Site-specific. If unknown, use 24 hours	hours	
kWh_{ex}	Annual energy consumption of existing unit	Site-specific, or look up in Table 3-47	kWh	[362]
kWh_q	Annual energy consumption of qualifying efficient unit	Look up in Table 3-48	kWh	[363]
kWh_b	Annual energy consumption of code-compliant baseline unit	Look up in Table 3-48	kWh	[362]
HVAC _c	HVAC interaction factor for annual electric energy consumption	0.080	N/A	
HVAC _d	HVAC interaction factor for peak demand at utility summer peak hour	0.175	N/A	
HVAC _{ff}	HVAC interaction factor for annual fossil fuel energy consumption	-0.002	MMBtu/kWh	
10	Unit conversion, Therm/MMBtu	10	Therm/MMBtu	
CF	Electric coincidence factor	Look up in Table 3-49	N/A	
PDF	Gas peak day factor	Look up in Table 3-49	N/A	
EUL	Effective useful life of new unit	See Measure Life Section	Years	
RUL	Remaining useful life of existing unit	See Measure Life Section	Years	

Table 3-46 Daily Energy Consumption of Code-Compliant Baseline Unit

Product Class	Daily Refrigerator Energy (kWh _o)
Vertical Closed	
Solid	<i>VCS.SC.M*</i>
All volumes	$0.05 \times V + 1.36$
Transparent	<i>VCT.SC.M</i>
All volumes	$0.1 \times V + 0.86$
Horizontal Closed	
Solid	<i>HCS.SC.M</i>
All volumes	$0.05 \times V + 0.91$
Transparent	<i>HCT.SC.M</i>
All volumes	$0.06 \times V + 0.37$

Where V = unit volume in cubic feet

* DOE Equipment Class designations relevant to ENERGY STAR eligible product scope

(1) Equipment family code (HCS= horizontal closed solid, HCT=horizontal closed transparent, VCS= vertical closed solid, VCT=vertical closed transparent).

(2) Operating mode (SC=self-contained).

(3) Rating Temperature (M=medium temperature (38 °F), L=low temperature (0 °F)).

Table 3-47 Daily Energy Consumption of Existing Unit

Product Class	Daily Refrigerator Energy when existing unit was manufactured before 03/26/2017 (kWh _{ex})	Daily Refrigerator Energy when existing unit was manufactured after 03/27/2017 (kWh _{ex})
Vertical Closed		
Solid	<i>VCS.SC.M</i>	<i>VCS.SC.M</i>
All volumes	$0.10 \times V + 2.04$	$0.05 \times V + 1.36$
Transparent	<i>VCT.SC.M</i>	<i>VCT.SC.M</i>
All volumes	$(0.12V + 3.34) \times 365$	$(0.1 \times V + 0.86) \times 365$
Horizontal Closed		
Solid	<i>HCS.SC.M</i>	<i>HCS.SC.M</i>
All volumes	$(0.10V + 2.04) \times 365$	$(0.05 \times V + 0.91) \times 365$
Transparent	<i>HCT.SC.M</i>	<i>HCT.SC.M</i>
All volumes	$(0.12V + 3.34) \times 365$	$(0.06 \times V + 0.37) \times 365$

Where V = unit volume in cubic feet

Table 3-48 Daily Energy Consumption of Qualifying Efficient Unit

Product Class	Daily Refrigerator Energy (kWh _q)
Vertical Closed	
Solid	<i>VCS.SC.M</i>
0 < V < 15	$0.0267 \times V + 0.8$
15 ≤ V < 30	$0.05 \times V + 0.45$
30 ≤ V < 50	$0.05 \times V + 0.45$
50 ≤ V	$0.025 \times V + 1.6991$
Transparent	<i>VCT.SC.M</i>
0 < V < 15	$0.095 \times V + 0.445$
15 ≤ V < 30	$0.05 \times V + 1.12$
30 ≤ V < 50	$0.076 \times V + 0.34$
50 ≤ V	$0.105 \times V - 1.111$
Horizontal Closed	
Solid or Transparent	<i>HCT.SC.M, HCS.SC.M</i>
All volumes	$0.05 \times V + 0.28$

Where V = unit volume in cubic feet

Peak Factors

Table 3-49 Peak Factors

Peak Factor	Value	Ref
Electric coincidence factor (CF)	1.0	
Natural gas peak day factor (PDF)	Appendix G: Natural Gas Peak Day Factors	

Measure Life

Table 3-50 Measure Life

Equipment	EUL	RUL	Ref
Commercial Reach-in Refrigerator	12	Site-specific. If unknown use 4 years	[365]

References

[362] Code of Federal Regulations, Energy Efficiency Program for Certain Commercial and Industrial Equipment, title 10, sec. 431.66 (2010).

- [363] ENERGY STAR Program Requirements Product Specification for Commercial Refrigerators and Freezers Eligibility Criteria Version 5.0, ENERGY STAR®, December 2022.
- [364] Code of Federal Regulations, Energy Efficiency Program for Certain Commercial and Industrial Equipment, title 10, sec. 431.66 (2013).
- [365] California Public Utilities Commission Database for Energy Efficient Resources (DEER) EUL Support Table for 2020. <http://www.deeresources.com/files/DEER2020/download/SupportTable-EUL2020.xlsx>

3.2.5 FREEZERS

Market	Commercial
Baseline Condition	TOS/NC/EREP/DI
Baseline	Code/ISP/Dual
End Use Subcategory	Kitchen
Measure Last Reviewed	January 2023

Description

This measure covers the installation of ENERGY STAR® compliant commercial freezers operating with an integral compressor and condenser. Eligible equipment includes commercial freezers and refrigerator-freezers. This measure is only applicable to horizontal or vertical self-contained equipment with solid or transparent doors.

In the case of early replacement of a working unit where the unit would have otherwise been installed until failure, remaining useful life (RUL) savings are claimed additional to the estimated useful life (EUL) savings of the new unit. Early replacement savings are calculated between existing unit and efficient unit consumption during the assumed remaining life of the existing unit, and between new baseline unit and efficient unit consumption for the remainder of the measure life. Assume that the remaining useful life of the existing unit equals 1/3 of the measure's effective useful life.

Baseline Case

Early Replacement (EREP) and Direct Install (DI): Early replacement and DI uses a dual baseline. The baseline is the existing unit for the remaining life of the existing unit and the baseline is a code-compliant/standard efficiency unit for the full measure life of the installed equipment.

Normal Replacement (NR) and New Construction (NC): The baseline condition is a minimally code compliant commercial freezer.

Baseline annual electric consumption shall align with federally mandated maximum energy use associated with the Product Class and the chilled or frozen compartment volume (V) of the qualifying equipment [366]. Volume specification shall be taken from ENERGY STAR® qualified products listing or specification sheet of the proposed equipment.

Efficient Case

The compliance condition is an ENERGY STAR® version 5.0 qualified commercial refrigerator-freezer or freezer. Annual electric energy consumption of the qualifying equipment shall come from application. Volume specification shall be taken from ENERGY STAR® qualified products listing or specification sheet of the proposed equipment.

Annual Energy Savings Algorithms

Annual Electric Energy Savings

Normal replacement (compared to code baseline):

$$\Delta kWh_{NR} = (kWh_b - kWh_q) \times (1 + HVAC_c) \times Days$$

Early replacement (compared to existing equipment):

$$\Delta kWh_{EREP} = (kWh_{ex} - kWh_q) \times (1 + HVAC_c) \times Days$$

Annual Fuel Savings

Normal replacement (compared to code baseline):

$$\Delta Therms_{NR} = (kWh_b - kWh_q) \times HVAC_{ff} \times 10 \times Days$$

Early replacement (compared to existing equipment):

$$\Delta Therms_{SEREP} = (kWh_{ex} - kWh_q) \times HVAC_{ff} \times 10 \times Days$$

Peak Demand Savings

Normal replacement (compared to code baseline):

$$\Delta kW_{Peak,NR} = \left(\frac{kWh_b - kWh_q}{Daily\ Hours} \right) \times (1 + HVAC_d) \times CF$$

Early replacement (compared to existing equipment):

$$\Delta kW_{Peak,EREP} = \left(\frac{kWh_{ex} - kWh_q}{Daily\ Hours} \right) \times (1 + HVAC_d) \times CF$$

Daily Peak Fuel Savings

$$\Delta Therms_{Peak} = \Delta Therms \times PDF$$

Lifetime Energy Savings Algorithms

Normal replacement (compared to code baseline):

Lifetime Electric Energy Savings

$$\Delta kWh_{Life} = \Delta kWh \times EUL$$

Lifetime Fuel Savings

$$\Delta Therms_{Life} = \Delta Therms \times EUL$$

Early replacement (compared to existing equipment):

Lifetime Electric Energy Savings

$$\Delta kWh_{Life} = \Delta kWh_{EREP} \times RUL + \Delta kWh_{NR} \times (EUL - RUL)$$

Lifetime Fuel Savings

$$\Delta Therms_{Life} = \Delta Therms_{SEREP} \times RUL + \Delta Therms_{NR} \times (EUL - RUL)$$

Calculation Parameters

Table 3-51 Calculation Parameters

Variable	Description	Value	Units	Ref
ΔkWh_{NR}	Annual electric energy savings for normal replacement	Calculated	kWh/yr	
ΔkWh_{EREP}	Annual electric energy savings for early replacement	Calculated	kWh/yr	
$\Delta Therms_{SNR}$	Annual fuel savings for normal replacement	Calculated	Therms/yr	
$\Delta Therms_{SEREP}$	Annual fuel savings for early replacement	Calculated	Therms/yr	
$\Delta kW_{Peak,NR}$	Peak Demand Savings for normal replacement	Calculated	kW	
$\Delta kW_{Peak,EREP}$	Peak Demand Savings for early replacement	Calculated	kW	
$\Delta Therms_{Peak}$	Daily peak fuel savings	Calculated	Therms/day	
ΔkWh_{Life}	Lifetime electric energy savings	Calculated	kWh	
$\Delta Therms_{Life}$	Lifetime fuel savings	Calculated	Therms	
V	Freezer unit volume	Site-specific	ft ³	
Days	Number of days of operations in a year	Site-specific. If unknown, use 365 days	days	
Daily Hours	Hours of operation in a day	Site-specific. If unknown, use 24 hours	hours	
kWh_{ex}	Annual energy consumption of existing unit	Site-specific. If unknown, look up in Table 3-53	kWh/yr	
kWh_q	Annual energy consumption of qualifying efficiency unit	Site-specific. If unknown, look up in Table 3-53	kWh/yr	[368]
kWh_b	Annual energy consumption of code-compliant baseline unit	Look up in Table 3-52	kWh/yr	[366]
CF	Electric coincidence factor	Look up in Table 3-55	N/A	
PDF	Gas peak day factor	Look up in Table 3-55	N/A	
HVAC _c	HVAC interaction factor for annual electric energy consumption	0.080	N/A	
HVAC _d	HVAC interaction factor for peak demand at utility summer peak hour	0.175	N/A	

Variable	Description	Value	Units	Ref
HVAC _{ff}	HVAC interaction factor for annual fossil fuel energy consumption	-0.002	MMBtu/kWh	
8,760	Hours per year	8,760	Hrs/yr	
10	Unit conversion, Therm/MMBtu	10	Therm/MMBtu	
EUL	Effective useful life of new unit	See Measure Life Section	Years	
RUL	Remaining useful life of existing unit	See Measure Life Section	Years	

Table 3-52 Current Federal Standard Baseline Equipment Daily Energy Consumption

Type	Freezer	
	Solid Door	Transparent Door
Vertical	$0.22 \times V + 1.38$	$0.29 \times V + 2.95$
Horizontal	$0.06 \times V + 1.12$	$0.08 \times V + 1.23$

Table 3-53 Energy Star Equipment Daily Energy Consumption

Volume (ft ³)	Vertical Closed Freezer		Horizontal Closed Freezer
	Solid Door	Transparent Door	Solid or Transparent Door
$0 < V < 15$	$0.21 \times V + 0.9$	$0.232 \times V + 2.36$	$0.057 \times V + 0.55$
$15 \leq V < 30$	$0.12 \times V + 2.248$	$0.232 \times V + 2.36$	$0.057 \times V + 0.55$
$30 \leq V < 50$	$0.258 \times V - 2.703$	$0.232 \times V + 2.36$	$0.057 \times V + 0.55$
$50 \leq V$	$0.142 \times V + 4.445$	$0.232 \times V + 2.36$	$0.057 \times V + 0.55$

Table 3-54 Existing Equipment Daily Energy Consumption

Type	Freezer	
	Solid Door	Transparent Door
Manufactured after 03/27/2017		
Vertical	$0.22 \times V + 1.38$	$0.29 \times V + 2.95$
Horizontal	$0.06 \times V + 1.12$	$0.08 \times V + 1.23$
Manufactured before 03/27/2017		
Vertical	$0.40 \times V + 1.38$	$0.75 \times V + 4.10$
Horizontal	$0.40 \times V + 1.38$	$0.75 \times V + 4.10$

Peak Factors

Table 3-55 Peak Factors

Peak Factor	Value	Ref
Electric coincidence factor (CF)	1	[366]
Natural gas peak day factor (PDF)	N/A	

Measure Life

Table 3-56 Measure Life

Equipment	EUL	RUL	Ref
Freezer	12	Site-specific. If unknown, use 4 years	[367]

References

- [366] 10 CFR Appendix A to Subpart C of Part 431 – Uniform Test Method for the Measurement of Energy Consumption of Commercial Refrigerators, Freezers, and Refrigerator-Freezers.
<https://www.ecfr.gov/current/title-10/chapter-II/subchapter-D/part-431/subpart-C/subject-group-ECFR8115bf7451f830f/section-431.66>
- [367] 2008 Database for Energy-Efficiency Resources (DEER), Version 2008.2.05, *Effective/Remaining Useful Life Values*, California Public Utilities Commission (December 16, 2008).
- [368] ENERGY STAR® Program Requirements Product Specification for Commercial Refrigerators and Freezers, Eligibility Criteria Version 5.0. (2022).

3.2.6 DEHUMIDIFIER

Market	Commercial
Baseline Condition	TOS/NC
Baseline	Code/ISP
End Use Subcategory	Indoor Environment
Measure Last Reviewed	January 2023

Description

This measure covers the installation of commercial stand-alone or ducted dehumidifiers meeting the minimum qualifying efficiency standards established under the ENERGY STAR® Program, Version 5.0, effective October 31, 2019. With a higher Energy Factor than comparable non-qualified models, ENERGY STAR® dehumidifiers have more efficient refrigeration coils, compressors, and fans that use less energy to remove moisture in Commercial buildings. Dehumidifiers originally qualified for the ENERGY STAR® label in January 2001. Dehumidifiers that have earned this label are approximately 15% more efficient than non-qualified models. This measure is restricted to dehumidifiers with a product moisture removal capacity of less than or equal to 185 pints/day.

Baseline Case

The baseline condition is a stand-alone or ducted dehumidifier meeting the minimum effective federal standard for performance.

Dehumidifiers manufactured and distributed in commerce on or after June 13, 2019 must meet the energy conservation standards, rated in Integrated Energy Factor as specified in the Code of Federal Regulations.

Efficient Case

The compliance condition is an ENERGY STAR® v. 5 qualified stand-alone or whole-house dehumidifier.

Annual Energy Savings Algorithms

Annual Electric Energy Savings

$$\Delta kWh = \frac{\text{pints/day} \times 0.473 \times \text{hrs}}{24} \times \left(\frac{1}{IEF_b} - \frac{1}{IEF_q} \right)$$

Annual Fuel Savings

$$\Delta \text{Therms} = N/A$$

Peak Demand Savings

$$\Delta kW_{\text{Peak}} = \frac{\Delta kWh}{\text{hrs}} \times CF$$

Daily Peak Fuel Savings

$$\Delta Therms_{Peak} = N/A$$

Lifetime Energy Savings Algorithms

Lifetime Electric Energy Savings

$$\Delta kWh_{Life} = \Delta kWh \times EUL$$

Lifetime Fuel Savings

$$\Delta Therms_{Life} = N/A$$

Calculation Parameters

Table 3-57 Calculation Parameters

Variable	Description	Value	Units	Ref
ΔkWh	Annual electric energy savings	Calculated	kWh/yr	
ΔkW_{Peak}	Peak Demand Savings	Calculated	kW	
ΔkWh_{Life}	Lifetime electric energy savings	Calculated	kWh	
Pints/day	Product capacity to remove moisture	Site-specific	pints/day	
hrs	Annual run hours of dehumidifier	1,632	N/A	[369]
IEF_b	Baseline Integrated Energy Factor	Look up in Table 3-58 & Table 3-59	liters/kWh	[370]
IEF_q	Energy Efficient Integrated Energy Factor	Site-specific. If unknown, look up in Table 3-60 & Table 3-61	liters/kWh	[371]
0.473	Conversion factor from liters to pint	0.473	liters/pint	
24	Hours in one day	24	N/A	
CF	Electric coincidence factor	0.405	N/A	[372]
EUL	Effective useful life	See Measure Life Section	Years	

Table 3-58 Stand-Alone Dehumidifiers Baseline Integrated Energy Factor

Product Capacity (pints/day)	Integrated Energy Factor (liters/kWh)
≤ 25.00	1.30
25.01 to 50.00	1.60
≥ 50.01	2.80

Table 3-59 Whole-Home (Ducted) Dehumidifiers Baseline Integrated Energy Factor

Product Case Volume (ft ³)	Integrated Energy Factor (liters/kWh)
≤ 8.0	≥1.77
> 8.0	≥2.41

Table 3-60 Stand-Alone Dehumidifiers Energy Efficient Integrated Energy Factor

Product Capacity (pints/day)	Integrated Energy Factor (liters/kWh)
≤ 25.00	≥1.57
25.01 to 50.00	≥1.80
≥50.01	≥3.30

Table 3-61 Whole-Home (Ducted) Dehumidifiers Energy Efficient Integrated Energy Factor

Product Case Volume (ft ³)	Integrated Energy Factor (liters/kWh)
≤ 8.0	≥2.09
> 8.0	≥3.30

Peak Factors

Table 3-62 Peak Factors

Peak Factor	Value	Ref
Electric coincidence factor (CF)	N/A	
Natural gas peak day factor (PDF)	N/A	

Measure Life

The effective useful life (EUL) is 12 years [373].

The remaining useful life (RUL) for existing equipment is limited to 1/3 of the effective useful life (EUL) of the equipment.

Table 3-63 Measure Life

Equipment	EUL	RUL	Ref
Dehumidifier	12	4	[373]

References

- [369] "ENERGY STAR Appliance Calculator". <https://www.energy.gov/energysaver/maps/appliance-energy-calculator>. n.d. Accessed December 21, 2022.
- [370] 10 CFR 430.32(v)(2), January 2023 [https://www.ecfr.gov/current/title-10/chapter-II/subchapter-D/part-430/subpart-C/section-430.32#p-430.32\(v\)\(2\)](https://www.ecfr.gov/current/title-10/chapter-II/subchapter-D/part-430/subpart-C/section-430.32#p-430.32(v)(2))
- [371] ENERGY STAR® Program Requirements Product Specification for Dehumidifiers, Eligibility Criteria Version 5.0, October 2019.
- [372] Dehumidifier Metering in PA and Ohio by ADM from 7/17/2013 to 9/22/2013. 31 Units metered. Assumes all non-coincident peaks occur within window and that the average load during this window is representative of the June PJM days as well.
- [373] New York Standard Approach for Estimating Energy Savings from Energy Efficiency Programs (TRM), Version 9, January 2022.
[https://www3.dps.ny.gov/W/PSCWeb.nsf/96f0fec0b45a3c6485257688006a701a/72c23decff52920a85257f1100671bdd/\\$FILE/NYS%20TRM%20V9.pdf](https://www3.dps.ny.gov/W/PSCWeb.nsf/96f0fec0b45a3c6485257688006a701a/72c23decff52920a85257f1100671bdd/$FILE/NYS%20TRM%20V9.pdf)

3.2.7 ROOM AIR CONDITIONER

Market	Commercial
Baseline Condition	TOS/NC/DI
Baseline	Code/Dual
End Use Subcategory	Indoor Environment
Measure Last Reviewed	January 2023

Description

This measure relates to the purchase and installation of a room air conditioning unit that meets the ENERGY STAR minimum qualifying efficiency specifications as presented in this section. This measure is for ENERGY STAR room air conditioner units installed in small commercial spaces. All HVAC applications other than comfort cooling and heating, such as process cooling, are defined as non-standard applications and are ineligible for this measure.

Baseline Case

Room air conditioner having energy efficiency ratio (EER) as per Code of Federal Regulation's combined energy efficiency ratio (CEER).

Efficient Case

Room air conditioner meeting the requirements of Energy Star 4.2 room air conditioner specification.

Annual Energy Savings Algorithms

Annual Electric Energy Savings

$$\Delta kWh = EFLH_c \times Cap \times \left(\frac{1}{CEER_b} - \frac{1}{CEER_q} \right) / 1,000$$

Annual Fuel Savings

$$\Delta Therms = N/A$$

Peak Demand Savings

$$\Delta kW_{Peak} = \frac{\Delta kWh}{EFLH_c} \times CF$$

Daily Peak Fuel Savings

$$\Delta Therms_{Peak} = N/A$$

Lifetime Energy Savings Algorithms

Lifetime Electric Energy Savings

$$\Delta kWh_{Life} = \Delta kWh \times EUL$$

Lifetime Fuel Savings

$$\Delta Therms_{Life} = N/A$$

Calculation Parameters

Table 3-64 Calculation Parameters

Variable	Description	Value	Units	Ref
ΔkWh	Annual electric energy savings	Calculated	kWh/yr	
ΔkW_{Peak}	Peak Demand Savings	Calculated	kW	
ΔkWh_{Life}	Lifetime electric energy savings	Calculated	kWh	
Cap	Cooling capacity of efficient equipment	Site-specific	Btu/hr	
$EFLH_c$	Equivalent Full Load Hours of operation for the average unit during the cooling season	, limit to small commercial buildings	Hours	[374]
$CEER_b$	Efficiency of baseline unit	Look up in Table 3-65	Btu/hr/watt	[375]
$CEER_q$	Efficiency of efficient unit	Site specific or defaults in lookup in Table 3-65	Btu/hr/watt	[376]
CF	Electric coincidence factor	Look up in Table 3-66	N/A	
EUL	Effective useful life	See Measure Life Section	Years	
RUL	Remaining useful life of existing unit	See Measure Life Section	Years	
1,000	Conversion from watts to kW	1,000	Watts/kW	

Table 3-65 Standard and ENERGY STAR CEER values for room air conditioner

Product Type and Class (Btu/hour)		Federal standard with louvered sides (CEER)	Federal standard without louvered sides (CEER)	ENERGY STAR with louvered sides (CEER)	ENERGY STAR without louvered sides (CEER)
Without reverse cycle	<6,000	11.0	10.0	12.1	11.0
	6,000 to 7,999	11.0	10.0	12.1	11.0
	8,000 to 10,999	10.9	9.6	12.0	10.6
	11,000 to 13,999	10.9	9.5	12.0	10.5
	14,000 to 19,999	10.7	9.3	11.8	10.2

Product Type and Class (Btu/hour)		Federal standard with louvered sides (CEER)	Federal standard without louvered sides (CEER)	ENERGY STAR with louvered sides (CEER)	ENERGY STAR without louvered sides (CEER)
	20,000 to 27,999	9.4	9.4	10.3	10.3
	≥28,000	9.0	9.4	9.9	10.3
With reverse cycle	<14,000	N/A	9.3	N/A	10.2
	≥14,000	N/A	8.7	N/A	9.6
	<20,000	9.8	N/A	10.8	N/A
	≥20,000	9.3	N/A	10.2	N/A
Casement-only ⁷¹		9.5		10.5	
Casement slider ⁷²		10.4		11.4	

Peak Factors

Table 3-66 Peak Factors

Peak Factor	Value	Ref
Electric coincidence factor (CF)	0.31	[377]
Natural gas peak day factor (PDF)	N/A	

Measure Life

The remaining useful life (RUL) for existing equipment is limited to 1/3 of the effective useful life (EUL) of the equipment.

Table 3-67 Measure Life

Equipment	EUL	RUL	Ref
Room Air Conditioner	9	3	[378]

⁷¹ Casement-only refers to a RAC designed for mounting in a casement window with an encased assembly with a width of ≤ 14.8 inches and a height of ≤ 11.2 inches.

⁷² Casement-slider refers to a RAC with an encased assembly designed for mounting in a sliding or casement window with a width of ≤ 15.5 inches.

References

- [374] Simulations of prototype buildings from NY TRM updated with NJ weather done by NJ Statewide Evaluator, May 2022.
- [375] Code of Federal Regulations – Title 10, Chapter II, Subchapter D, Part 430, Subpart C, §430.32., January 2023 <https://www.ecfr.gov/current/title-10/chapter-II/subchapter-D/part-430/subpart-C/section-430.32>
- [376] ENERGY STAR Program Requirements for Room Air Conditioners, Eligibility Criteria, Version 4.0, January 2023 https://www.energystar.gov/products/heating_cooling/air_conditioning_room/key_product_criteria
- [377] NEEP, Mid-Atlantic Technical Reference Manual, V8. pp 77-80., May 2018 <https://neep.org/sites/default/files/resources/Mid Atlantic TRM V8 0.pdf>
- [378] PA TRM Energy Efficiency and Conservation Programs (TRM), Version 9, January 2023.

3.2.8 WATER COOLER

Market	Commercial
Baseline Condition	NC/TOS
Baseline	Code
End Use Subcategory	Kitchen
Measure Last Reviewed	January 2023

Description

This measure estimates savings for installing ENERGY STAR Water Coolers compared to standard efficiency equipment in commercial applications. The measurement of energy and demand savings is based on a deemed savings value multiplied by the quantity of the measure.

Baseline Case

Water cooler meeting Energy Star v. 2.0 Water Cooler requirements as directed by N.J. PL 2021, c. 464.

Efficient Case

ENERGY STAR v. 3.0 compliant water cooler.

Annual Energy Savings Algorithms

Annual Electric Energy Savings

$$\Delta kWh = (kWh_b - kWh_q) \times 365$$

Annual Fuel Savings

$$\Delta Therms = N/A$$

Peak Demand Savings

$$\Delta kW_{Peak} = \frac{\Delta kWh}{Hr} \times CF$$

Daily Peak Fuel Savings

$$\Delta Therms_{Peak} = N/A$$

Lifetime Energy Savings Algorithms

Lifetime Electric Energy Savings

$$\Delta kWh_{Life} = \Delta kWh \times EUL$$

Lifetime Fuel Savings

$$\Delta Therms_{Life} = N/A$$

Calculation Parameters

Table 3-68 Calculation Parameters

Variable	Description	Value	Units	Ref
ΔkWh	Annual electric energy savings	Calculated	kWh/yr	
ΔkW_{Peak}	Peak Demand Savings	Calculated	kW	
ΔkWh_{Life}	Lifetime electric energy savings	Calculated	kWh	
Hr	Annual hours of operation	Site-specific, if unknown assume 8,760	Hrs	
kWh_b	Energy use of baseline water cooler	Look up in Table 3-69	kWh/day	[379]
kWh_q	Energy use of energy efficient water cooler	Site-specific, if unknown look up in Table 3-69	kWh/day	[380]
CF	Electric coincidence factor	Look up in Table 3-70	N/A	
PDF	Gas peak day factor	Look up in Table 3-70	N/A	
EUL	Effective useful life	See Measure Life Section	Years	

Table 3-69 Water Cooler Energy Use

Energy Star Water Cooler Type Product Capacity Class, and Conditioning Method	Baseline kWh_b (kWh/day)	Default Efficient kWh_q (kWh/day)
Cold Only	0.16	0.16
Hot & Cold – Low Capacity ⁷³	0.87	0.68
Hot & Cold – High Capacity ⁷⁴	0.87	0.80
Hot & Cold On-Demand	0.18	0.18

⁷³ A water cooler with a cold-water dispenser capacity of 0.50 gallons per hour or less, as measured per ANSI/ASHRAE Standard 18. For units that also provide hot water, the unit must have a hot-water dispenser capacity that is equal to or less than 41 exact 6 oz. cups per hour, as rated per ANSI/ASHRAE Standard 18.

⁷⁴ A water cooler with a cold-water dispenser capacity that is greater than 0.50 gallons per hour, as measured per ANSI/ASHRAE Standard 18. For units that also provide hot water, the unit must have a hot-water dispenser capacity greater than 41 exact 6 oz. cups per hour, as rated per ANSI/ASHRAE Standard 18.

Peak Factors

Table 3-70 Peak Factors

Peak Factor	Value	Ref
Electric coincidence factor (CF)	1.0	[381]
Natural gas peak day factor (PDF)	N/A	

Measure Life

The effective useful life (EUL) is 10 years. [379]

References

- [379] ENERGY STAR Product Specifications for Water Coolers Version 2.0.
<https://www.energystar.gov/sites/default/files/specs//ES%20WC%20V2%200%20Spec.pdf>
- [380] ENERGY STAR Product Specifications for Water Coolers Version 3.0.
https://www.energystar.gov/sites/default/files/asset/document/ENERGY%20STAR%20Verison%203.0%20Water%20Coolers%20Final%20Specification_0.pdf
- [381] Assumes 24/7 operation. Site-specific load shape information should be used if known.

3.3 APPLIANCE RECYCLING

3.3.1 REFRIGERATOR & FREEZER RECYCLING

Market	Commercial
Baseline Condition	ERET
Baseline	Existing
End Use Subcategory	Recycling
Measure Last Reviewed	January 2023

Description

In many cases, when a refrigerator or freezer is replaced by a building owner, the existing unit is retained, sold, or donated for use elsewhere, representing additional load on the grid. This measure covers recycling of the existing, functional equipment, thereby eliminating the consumption associated with that equipment. Refrigerator and freezer recycling programs (also called “bounty” programs) receive energy savings credit for permanently removing inefficient, functional refrigerators and freezers from the electric grid.

This measure covers the recycling of primary (i.e., installed in a kitchen) and secondary (i.e., installed elsewhere) refrigerators, refrigerator-freezers and freezers. To account for the fact that secondary equipment is occasionally installed and operating for only part of the year, a part-time use adjustment factor has been developed and embedded within the gross savings estimate for secondary units to establish average annual per unit deemed electric savings.

This measure does not cover the recycling of equipment classified by the Code of Federal Regulations as “Compact refrigerator/refrigerator-freezer/freezer”. This refers to any refrigerator, refrigerator-freezer or freezer with a total refrigerated volume of less than 7.75 ft³ (220 liters), where the total refrigerated volume has been determined in accordance with the procedure prescribed in Appendix A (refrigerators and refrigerator-freezers) or B (freezers) of 10 CFR 430 Subpart B.112.

Note: The following values are developed for residential equipment installed in commercial buildings. There currently is no methodology for recycling of commercial scale refrigerators and freezers.

Baseline Case

The savings calculations below apply to recycling of a functioning primary or secondary refrigerator, refrigerator-freezer, or freezer with total refrigerated volume of 7.75 ft³ (220 liters) or more.

Efficient Case

The compliance condition is the recycling of an existing refrigerator or freezer as defined in the Measure Description section above.

Annual Energy Savings Algorithms

Annual Electric Energy Savings

$$\Delta kWh = \left(\frac{\Delta kWh}{unit} \right)$$

Annual Fuel Savings

$$\Delta Therms = N/A$$

Peak Demand Savings

$$\Delta kW_{Peak} = \left(\frac{\Delta kW}{unit} \right)$$

Daily Peak Fuel Savings

$$\Delta Therms_{Peak} = N/A$$

Lifetime Energy Savings Algorithms

Lifetime Electric Energy Savings

$$\Delta kWh_{Life} = \Delta kWh \times EUL$$

Lifetime Fuel Savings

$$\Delta Therms_{Life} = N/A$$

Calculation Parameters

Table 3-71 Calculation Parameters

Variable	Description	Value	Units	Ref
ΔkWh	Annual electric energy savings	Calculated	kWh/yr	
ΔkW_{Peak}	Peak Demand Savings	Calculated	kW	
ΔkWh_{Life}	Lifetime electric energy savings	Calculated	kWh	
$\Delta kWh/unit$	Energy Savings	Lookup in Table 3-72	kWh	[383]
$\Delta kW/unit$	Demand Savings per unit	Lookup in Table 3-72	kWh	[383]
CF	Electric coincidence factor	Look up in Table 3-73	N/A	
PDF	Gas peak demand factor	Look up in Table 3-73	N/A	
EUL	Effective useful life	See	Years	[382]

Table 3-72 Default Values for Annual Energy and Peak Demand Savings

	Primary Refrigerator	Secondary Refrigerator	Freezer
Δ kWh/unit	958	581	593
Δ kW/unit	0.15	0.10	0.10

Peak Factors

Table 3-73 Peak Factors

Peak Factor	Value	Ref
Electric coincidence factor (CF)	N/A	
Natural gas peak day factor (PDF)	N/A	

Measure Life

The effective useful life (EUL) is 5 years for a refrigerator and 4 years for a freezer [382].

References

- [382] California Public Utilities Commission Database for Energy Efficient Resources (DEER) EUL Support Table for 2020, <http://www.deeresources.com/files/DEER2020/download/SupportTable-EUL2020.xlsx>
- [383] DNV, Appliance Recycling Program Impact Evaluation Study, June 2021
<https://documents.dps.ny.gov/public/Common/ViewDoc.aspx?DocRefId=%7BE846898E-5EAE-4F42-9F97-385982740AC6%7D>

3.3.2 ROOM AC UNIT RECYCLING

Market	Commercial
Baseline Condition	ERET
Baseline	Existing
End Use Subcategory	Recycling
Measure Last Reviewed	January 2023

Description

In many cases where a business removes an appliance, the existing unit is retained, sold, or donated for use elsewhere and represents additional load on the grid. This measure covers recycling of the existing functional equipment, thereby eliminating the consumption associated with that equipment. This measure is applicable to commercial and multi-family high-rise buildings. This measure assumes that a percentage of these units will ultimately be replaced with a baseline standard efficiency unit (note that if it is actually replaced by a new ENERGY STAR qualifying unit, the savings increment between baseline and ENERGY STAR should be captured under the Room AC measure).

A room air conditioner is an appliance, other than a “packaged terminal air conditioner,” which is powered by a single-phase electric current and that is an encased assembly designed as a unit for mounting in a window or through the wall for the purpose of providing delivery of conditioned air to an enclosed space.

Baseline Case

The baseline condition is the existing inefficient room air conditioning unit.

Efficient Case

Not applicable. This measure relates to the retiring of an existing inefficient unit. However, a percentage of units are assumed to be replaced with a baseline new unit, and the savings are therefore reduced to account for these replacement units.

Annual Energy Savings Algorithms

Annual Electric Energy Savings

$$\Delta kWh = \frac{EFLH_c \times Btuh \times (1/EER_{exist})}{1,000} - F_{replaced} \times \frac{EFLH_c \times Btuh \times (1/CEER_{new})}{1,000}$$

Annual Fuel Savings

$$\Delta Therms = N/A$$

Peak Demand Savings

$$\Delta kW_{Peak} = \frac{\Delta kWh}{EFLH_c} \times CF$$

Daily Peak Fuel Savings

$$\Delta Therms_{Peak} = N/A$$

Lifetime Energy Savings Algorithms

Lifetime Electric Energy Savings

$$\Delta kWh_{Life} = \Delta kWh \times EUL$$

Lifetime Fuel Savings

$$\Delta Therms_{Life} = N/A$$

Calculation Parameters

Table 3-74 Calculation Parameters

Variable	Description	Value	Units	Ref
ΔkWh	Annual electric energy savings	Calculated	kWh/yr	
ΔkW_{Peak}	Peak Demand Savings	Calculated	kW	
ΔkWh_{Life}	Lifetime electric energy savings	Calculated	kWh	
$EFLH_c$	Effective full-load cooling hours		Hours	[385]
Btuh	Capacity of replaced unit	Site-specific, if unknown assume 7,829	Btu/hr	[386]
EER_{exist}	Efficiency of existing unit	Site-specific, if unknown assume 9.8	Btu/W/hr	[387][66]
$F_{replaced}$	Fraction of units dropped off that are replaced in the home	0.38	N/A	[389]
$CEER_{new}$	Efficiency of new unit	10.9	Btu/W/hr	[388]
CF	Electric coincidence factor	Look up in Table 3-75	N/A	
PDF	Gas peak day factor	Look up in Table 3-75	N/A	
EUL	Effective useful life	See Measure Life Section	Years	

Peak Factors

Table 3-75 Peak Factors

Peak Factor	Value	Ref
Electric coincidence factor (CF)	0.3	[386]
Natural gas peak day factor (PDF)	N/A	

Measure Life

The effective useful life (EUL) is 3 years. [384]

References

- [384] California Public Utilities Commission Database for Energy Efficient Resources (DEER) EUL Support Table for 2020, <http://www.deeresources.com/files/DEER2020/download/SupportTable-EUL2020.xlsx> .
- [385] From MidAtlantic TRM v10: "VEIC calculated the average ratio of FLH for Room AC (provided in RLW Report: Final Report Coincidence Factor Study Residential Room Air Conditioners, June 23, 2008) to FLH for Central Cooling at 31%. Applying this to the FLH for Central Cooling provided for Baltimore (1050) we get 325 FLH for Room AC."
- [386] RLW Report: Final Report Coincidence Factor Study Residential Room Air Conditioners (June 23, 2008 p. 22), based on population average.
https://www.puc.nh.gov/electric/Monitoring%20and%20Evaluation%20Reports/National%20Grid/124_SPWG%20Room%20%20AC%20Evaluation%20FINALReport%20June%2023%20ver7.pdf
- [387] Minimum Federal Standard for most common room AC type (8000-14,999 capacity range with louvered sides) per federal standards from 10/1/2000 to 5/31/2014.
- [388] Minimum Federal Standard for most common Room AC type (8000-14,999 capacity range with louvered sides). Current federal standards use CEER while previous federal standards used EER for efficiency levels.
- [389] *Mid-Atlantic TRM Manual: Version 10* (NEEP, 2020), Pg 110 <https://neep.org/mid-atlantic-technical-reference-manual-trm-v10>.

3.3.3 DEHUMIDIFIER RECYCLING

Market	Commercial
Baseline Condition	ERET
Baseline	Existing
End Use Subcategory	N/A
Measure Last Reviewed	January 2023

Description

In many cases, when a dehumidifier is replaced by a building owner, the existing unit is retained, sold or donated for use elsewhere, representing additional load on the grid. This measure covers recycling of existing, functional, portable dehumidifiers, thereby eliminating the consumption associated with that equipment. This measure should target, but not be limited to dehumidifiers put into service prior to June 2019. If provided data indicates the unit is replaced rather than retired, savings shall be based on the Commercial Dehumidifier measure in this TRM.

Baseline Case

The baseline condition is the existing inefficient dehumidifier.

Efficient Case

The existing inefficient dehumidifier is removed from service and not replaced.

Annual Energy Savings Algorithms

Annual Electric Energy Savings

$$\Delta kWh = capacity \times \frac{0.473}{24} \times hrs \times \frac{1}{L/kWh}$$

Annual Fuel Savings

$$\Delta Therms = N/A$$

Peak Demand Savings

$$\Delta kW_{Peak} = \frac{\Delta kWh}{hrs} \times CF$$

Daily Peak Fuel Savings

$$\Delta Therms_{Peak} = N/A$$

Lifetime Energy Savings Algorithms

Lifetime Electric Energy Savings

$$\Delta kWh_{Life} = \Delta kWh \times RUL$$

Lifetime Fuel Savings

$$\Delta Therms_{Life} = N/A$$

Calculation Parameters

Table 3-76 Calculation Parameters

Variable	Description	Value	Units	Ref
ΔkWh	Annual electric energy savings	Calculated	kWh/yr	
ΔkW_{Peak}	Peak Demand Savings	Calculated	kW	
ΔkWh_{Life}	Lifetime electric energy savings	Calculated	kWh	
Capacity	Capacity of the unit	Site-specific. If unknown, use 56 pints/day	pints/day	
L/kWh	Dehumidifier Efficiency	Look up in Table 3-77	L/kWh	[391][393][394]
0.473	Conversion factor	0.473	L/pint	
24	Conversion factor	24	Hr/day	
Hrs	Hours of use	1632	Hours	[391]
CF	Electric coincidence factor	Look up in Table 3-78	N/A	
PDF	Gas peak day factor	Look up in Table 3-78	N/A	
RUL	Remaining useful life	See Measure Life Section	Years	

Table 3-77 Dehumidifier Capacity and Efficiency

Capacity Range (pints/day)	ENERGY STAR Labeled (L/kWh)	Non-ENERGY STAR Labeled	
		Manufacture date before Oct. 2012 (\geq L/kWh)	Manufacture date of Oct. 2012 or later (\geq L/kWh)
≤ 25	1.57	1.00	1.35
>25 to ≤ 35	1.80	1.20	1.35
>35 to ≤ 45	1.80	1.30	1.50
>45 to ≤ 50	1.80	1.30	1.60
>50 to ≤ 55	3.30	1.30	1.60
>54 to ≤ 75	3.30	1.50	1.70

Capacity Range (pints/day)	ENERGY STAR Labeled (L/kWh)	Non-ENERGY STAR Labeled	
		Manufacture date before Oct. 2012 (\geq L/kWh)	Manufacture date of Oct. 2012 or later (\geq L/kWh)
>75 to \leq 185	3.30	2.25	2.50

Peak Factors

Table 3-78 Peak Factors

Peak Factor	Value	Ref
Electric coincidence factor (CF)	0.405	[372]
Natural gas peak day factor (PDF)	N/A	

Measure Life

The remaining useful life (RUL) is 4 years [390].

References

- [390] CA DEER gives the following rule-of-thumb for remaining useful life: $RUL = (1/3) \times EUL$. As the Energy Star Dehumidifier [replacement] uses an EUL of 12 years, we have a suggested RUL of $(1/3) \times 12$ years = 4 years.
- [391] Savings Calculator for ENERGY STAR® Qualified Appliances Version 3.0 Last Updated October 1, 2012.
- [392] ENERGY STAR® Program Requirements for Dehumidifiers, Version 5.0, February 2019.
- [393] 42 U.S.C, Title 42 Chapter 77, Subchapter III, Part A, (cc)(1) and (cc)(2).
<https://uscode.house.gov/view.xhtml?path=/prelim@title42/chapter77/subchapter3&edition=prelim>
- [394] Code of Federal Regulations Title 10, Chapter 2, Subchapter D, Part 430, Subpart C (v)(1).
<https://www.ecfr.gov/current/title-10/chapter-II/subchapter-D/part-430/subpart-C>
- [395] Dehumidifier Metering in PA and Ohio by ADM from 7/17/2013 to 9/22/2013. 31 Units metered. Assumes all non-coincident peaks occur within window and that the average load during this window is representative of the June PJM days as well.

3.4 FOODSERVICE

3.4.1 OVENS, FRYER, STEAMER & GRIDDLE

Market	Commercial
Baseline Condition	TOS
Baseline	Code
End Use Subcategory	Cooking equipment
Measure Last Reviewed	January 2023

Description

This measure covers the installation of qualified commercial kitchen equipment that exceeds the efficiency standards specified in the New Jersey P.L. 2021, c. 464 meets the descriptions below.

- **Convection Ovens [397]** – This measure includes gas and electric commercial convection ovens. A convection oven forces hot dry air over the surface of a food product. A full-size convection oven can accommodate standard full-size sheet pans measuring 18 x 26 x 1 inch. A half-size convection oven can accommodate half-size sheet pans measuring 18 x 13 x 1 inch. Though not subject to minimum standards specified in the New Jersey P.L. 2021, c. 464, the baseline for half-size gas convection ovens were taken from a Pacific Gas & Electric workpaper [401].
- **Rack Ovens [397]** – This measure includes gas commercial rack ovens. A rack oven is a high-capacity oven in which a rack is wheeled into the oven and can be rotated during the baking process. Single and double rack ovens are included in this measure.
- **Steamers [398]** – This measure includes gas and electric commercial steamers, also known as compartment steamers. A steamer is a device that contains one or more food steaming compartments in which the energy in the steam is transferred to the food by direct contact. To calculate the savings for this measure, the number of pans must be known. Countertop, wall-mounted, and floor models mounted on a stand, pedestal, or cabinet-style base are included. Commercial steamer microwave ovens are not included in this measure.
- **Fryers [399]**– This measure includes gas and electric commercial deep-fat fryers. A deep-fat fryer is an appliance in which oils are placed to such a depth that the cooking food is essentially supported by displacement of the cooking fluid rather than by the bottom of the vessel. Depending on the fryer type, heat is delivered to the cooking fluid by means of an immersed electric element or band-wrapped vessel (electric fryers), or by heat transfer from gas burners through either the walls of the fryer or through tubes passing through the cooking fluid (gas fryers). Standard fryers and large vat fryers are included in this measure.
- **Griddles [400]** – This measure includes single-sided gas and electric commercial griddles. A single-sided commercial griddle is a commercial appliance designed for cooking food in oil or its own juices by direct contact with either a flat, smooth, hot surface or a hot channeled cooking surface where plate temperature is thermostatically controlled. To calculate the energy savings in this measure, the griddle dimensions must be known. This measure does not include double-sided gas or electric commercial griddles.

- **Gas Conveyor Ovens** – Though not eligible for ENERGY STAR® qualification, this measure additionally covers the installation of energy efficient gas conveyor ovens. Conveyor ovens cook food by carrying it on a moving belt through a heated chamber. Qualifying conveyor ovens have baking efficiencies greater than or equal to 42% and idle energy rates less than or equal to 57,000 Btu/h, per assumed efficiency of qualified equipment by Pacific Gas and Electric workpaper, where 1 pizza equals 0.76 lbs [402].

Baseline Case

The baseline idle energy and cooking efficiency is compliant with the New Jersey P.L. 2021, c. 464 minimum standards, which establishes Energy Star Program Requirements for Commercial Oven Version 2.2 as the baseline for electric and gas convection ovens and gas rack ovens, Energy Star Program Requirements for Commercial Fryers Version 2.0 as the baseline for electric and gas fryers and Energy Star Program Requirements for Commercial Steam Cookers, Version 1.2 as the baseline for electric and gas steamers.⁷⁵ Preheat energy and all values for half size gas convection ovens, conveyor ovens and griddles are reported from referenced FSTC sources.

Table 3-79 Equipment Baselines Case Default Characteristics

Equipment	Btu _{preheat,baseline} (Btu)	Btu/h _{idle,baseline} (Btu/h)	(lbs/hr) _{baseline}	Eff _{baseline}	Ref
Convection Oven, Electric, Full Size	5,118	5,459	70	0.71	[401][397]
Convection Oven, Electric, Half Size	3,412	3,412	45	0.71	[401][397]
Convection Oven, Gas, Full Size	19,000	12,000	70	0.46	[401][397]
Convection Oven, Gas, Half Size	13,000	12,000	45	0.30	[401]
Conveyor Oven, Gas	21,270	55,000	114	0.30	[411]
Rack Oven, Gas, Double Rack	100,000	30,000	250	0.52	[403][397]
Rack Oven, Gas, Single Rack	50,000	25,000	130	0.48	[407][397]
Steamer, Electric	5,118	3-pan: 1,365 4-pan: 1,808 5-pan: 2,286 6-pan and larger: 2,730	11.7 x No. of pans	0.50	[398][404]
Steamer, Gas	20,000	3-pan: 6,250 4-pan: 8,350 5-pan: 10,400	23.3 x No. of pans	0.38	[398][404]

⁷⁵ <https://legiscan.com/NJ/bill/A5160/2020>.

Equipment	Btu _{preheat,baseline} (Btu)	Btu/h _{idle,baseline} (Btu/h)	(lbs/hr) _{baseline}	Eff _{baseline}	Ref
		6-pan and larger: 12,500			
Fryer, Electric	8,189	3,412	65	0.80	[405][412]
Fryer, Gas	18,500	9,000	60	0.50	[405][412]
Griddle, Electric	4,436 x Griddle Width (ft)	2,730 x Griddle Width (ft)	11.7 x Griddle Width (ft)	0.60	[406]
Griddle, Gas	7,000 x Griddle Width (ft)	7,000 x Griddle Width (ft)	8.4 x Griddle Width (ft)	0.30	[406]

Efficient Case

The compliance condition is food service equipment that exceeds the minimum efficiency specified in New Jersey P.L. 2021, c. 464 or, in the case of conveyor ovens, half-size gas convection ovens and griddles, equipment aligning with FSTC assumptions for energy efficient products meeting the minimum performance specifications listed in the table below. Operating characteristics shall be taken from application. When unavailable, default characteristics shall be taken from Table 3-80.

Table 3-80 Equipment Efficient Case Default Characteristics

Equipment	Btu _{preheat,ee} (Btu)	Btu/h _{idle,ee} (Btu/h)	(lbs/hr) _{ee}	Eff _{ee}	Ref
Convection Oven, Electric, Full Size	3,412	4,606	82	0.76	[401][413]
Convection Oven, Electric, Half Size	3,071	2,593	53	0.76	[401][413]
Convection Oven, Gas, Full Size	11,000	9,349	82	0.51	[401][413]
Convection Oven, Gas, Half Size	7,500	4,293	53	0.53	[401][413]
Conveyor Oven, Gas	15,000	40,000	158	0.46	[402][411]
Rack Oven, Gas, Double Rack	85,000	24,600	280	0.56	[403][414]
Rack Oven, Gas, Single Rack	44,000	19,733	140	0.51	[407][414]
Steamer, Electric	5,118	990	14.7 x No. of pans	0.70	[404][415]
Steamer, Gas	9,000	1,221	20.8 x No. of pans	0.47	[404][415]
Fryer, Electric, Standard	6,483	2,327	71	0.86	[405][416]

Equipment	Btu _{preheat,ee} (Btu)	Btu/h _{idle,ee} (Btu/h)	(lbs/hr) _{ee}	Eff _{ee}	Ref
Fryer, Gas, Standard	16,000	7,571	67	0.52	[405][416]
Griddle, Electric	2,389 x Griddle Width (ft)	1,000 x Griddle Area (ft ²)	16.3 x Griddle Width (ft)	0.75	[406]
Griddle, Gas	5,000 x Griddle Width (ft)	2,068 x Griddle Area (ft ²)	16.4 x Griddle Width (ft)	0.46	[406]

Annual Energy Savings Algorithms

Annual Electric Energy Savings

$$\Delta kWh = days \times \frac{(\Delta Btu_{preheat} + \Delta Btu_{idle} + \Delta Btu_{cooking})}{3412}$$

Annual Fuel Savings

$$\Delta Therms = days \times \frac{(\Delta Btu_{preheat} + \Delta Btu_{idle} + \Delta Btu_{cooking})}{100,000}$$

Where:

$$\Delta Btu_{preheat} = N_{preheat} \times (Btu_{preheat,baseline} - Btu_{preheat,ee})$$

$$\Delta Btu_{idle} = Btu/h_{idle,baseline} \times [hrs - N_{preheat} \times hrs_{preheat} - \frac{lbs}{(lbs/hr)_{baseline}}] - Btu/h_{idle,ee} \times [hrs - N_{preheat} \times hrs_{preheat} - \frac{lbs}{(lbs/hr)_{ee}}]$$

$$\Delta Btu_{cooking} = lbs \times Q_{food} \times (\frac{1}{Eff_{baseline}} - \frac{1}{Eff_{ee}})$$

NOTE: $\Delta Btu_{preheat}$, ΔBtu_{idle} and $\Delta Btu_{cooking}$ terms can be calculated per the equations above using either actual qualifying equipment specs or default values as defined in the Common Variables, Baseline Efficiencies, Compliance Efficiency, and Operating Hours sections below, or looked up from Table 3-83.

Peak Demand Savings

$$\Delta kW_{Peak} = \frac{\Delta kWh}{(days \times hrs)} \times CF$$

Daily Peak Fuel Savings

$$\Delta Therms_{Peak} = \Delta Therms \times PDF$$

Lifetime Energy Savings Algorithms

Lifetime Electric Energy Savings

$$\Delta kWh_{Life} = \Delta kWh \times EUL$$

Lifetime Fuel Savings

$$\Delta Therms_{Life} = \Delta Therms \times EUL$$

Calculation Parameters

Table 3-81 Calculation Parameters

Variable	Description	Value	Units	Ref
ΔkWh	Annual electric energy savings	Calculated	kWh/yr	
$\Delta Therms$	Annual fuel savings	Calculated	Therms/yr	
ΔkW_{Peak}	Peak Demand Savings	Calculated	kW	
$\Delta Therms_{Peak}$	Daily peak fuel savings	Calculated	Therms/day	
ΔkWh_{Life}	Lifetime electric energy savings	Calculated	kWh	
$\Delta Therms_{Life}$	Lifetime fuel savings	Calculated	Therms	
$\Delta Btu_{preheat}$	Daily preheat energy savings	Calculate based on calculations above or look up in Table 3-83	Btu	
ΔBtu_{idle}	Daily idle energy savings	Calculate based on calculations above or look up in Table 3-83	Btu	
$\Delta Btu_{cooking}$	Daily cooking energy savings	Calculate based on calculations above or look up in Table 3-83	Btu	
days	Operating days per year	Site-specific, if unknown look up based on facility type in Table 3-82	Btu	
hrs	Daily operating hours	Site-specific, if unknown look up based on facility type in Table 3-82	hours	
$Btu_{preheat,baseline}$	Baseline Equipment preheat energy	Look up based on qualifying equipment type in Table 3-79	Btu	
$Btu_{preheat,ee}$	Energy Efficient Equipment preheat energy	Site-specific, if unknown look up based on qualifying equipment type in Table 3-80	Btu	

Variable	Description	Value	Units	Ref
N_{preheat}	Number of preheats per day	1		
$\text{hrs}_{\text{preheat}}$	Preheat duration	Look up based on qualifying equipment type in Table 3-84	hours	
$\text{Btu/h}_{\text{idle,baseline}}$	Baseline Equipment idle energy rate	Look up based on qualifying equipment type in Table 3-79	Btu/h	
$\text{Btu/h}_{\text{idle,ee}}$	Energy Efficient Equipment idle energy rate	Site-specific, if unknown look up based on qualifying equipment type in Table 3-80	Btu/h	
$(\text{lbs/hr})_{\text{baseline}}$	Baseline Equipment production capacity	Look up based on qualifying equipment type in Table 3-79	lbs/hr	
$(\text{lbs/hr})_{\text{ee}}$	Energy Efficient Equipment production capacity	Site-specific, if unknown look up based on qualifying equipment type in Table 3-80	lbs/hr	
lbs	Total daily food production	Site-specific, if unknown look up based on qualifying equipment type in Table 3-84	lbs	
Q_{food}	Heat to food	Look up based on qualifying equipment type in Table 3-84	Btu/lb	
$\text{Eff}_{\text{baseline}}$	Baseline Equipment convection/steam mode cooking efficiency	Look up based on qualifying equipment type in Table 3-79	N/A	
Eff_{ee}	Energy Efficient Equipment convection/steam mode cooking efficiency	Site-specific, if unknown look up based on qualifying equipment type in Table 3-80	N/A	
CF	Electric coincidence factor	Lookup in Table 3-85	N/A	[417]
PDF	Gas peak day factor	Lookup in Table 3-85	N/A	
EUL	Effective useful life	See Measure Life Section	Years	

Table 3-82 Operating Hours

Building Type	Days/Year	Hours/Day
Education – Primary School	180	8
Education -Secondary School	210	11
Education – Community College	237	16
Education – University	192	16
Grocery	364	16
Medical – Hospital	364	24
Medical – Clinic	351	12
Lodging Motel	364	24
Office – Large	234	12
Office – Small	234	12
Restaurant – Sit-Down	364	12
Restaurant – Fast-Food	364	17
Average = Miscellaneous	288	15

Table 3-83 contains values and simplified calculations for $\Delta Btu_{preheat}$, ΔBtu_{idle} and $\Delta Btu_{cooking}$ terms that may be used in the formulation of estimated savings in lieu of utilizing the calculations prescribed above for these terms. These values were established by performing those calculations using assumed values from the Common Variables, Baseline Efficiencies, and Compliance Efficiency sections.

Table 3-83 Default Values

Equipment	$\Delta Btu_{preheat}$	ΔBtu_{idle}	$\Delta Btu_{cooking}$
Convection Oven, Electric, Full Size	1,706	853 x hrs - 2395	2,317
Convection Oven, Electric, Half Size	341	819 x hrs - 2895	2,317
Convection Oven, Gas, Full Size	8,000	2651 x hrs - 6404	5,328
Convection Oven, Gas, Half Size	5,500	7707 x hrs - 20493	36,164
Conveyor Oven, Gas	6,270	15000 x hrs - 47315	55,072
Rack Oven, Gas, Double Rack	15,000	5400 x hrs - 40353	38,736
Rack Oven, Gas, Single Rack	6,000	5267 x hrs - 32553	17,279
Steamer, Electric ⁷⁶	0	1740 x hrs - 3201	6,000
Steamer, Gas ⁷⁷	11,000	11279 x hrs - 10783	5,291

⁷⁶ Assumes 6 pans

⁷⁷ Assumes 6 pans

Equipment	$\Delta Btu_{preheat}$	ΔBtu_{idle}	$\Delta Btu_{cooking}$
Fryer, Electric, Standard	1,706	1085 x hrs - 3229	7,456
Fryer, Gas, Standard	2,500	1429 x hrs - 5906	6,577
Griddle, Electric ⁷⁸	6,141	2190 x hrs - 11611	15,833
Griddle, Gas ⁷⁹	6,000	8592 x hrs - 60262	55,072

Table 3-84 Common Variables

Equipment	hrs _{preheat}	lbs	Q _{food} (Btu/lb)	Ref
Convection Oven, Electric, Full Size	0.25	100	250	[401]
Convection Oven, Electric, Half Size	0.25	100	250	[401]
Convection Oven, Gas, Full Size	0.25	100	250	[401]
Convection Oven, Gas, Half Size	0.25	100	250	[401]
Conveyor Oven, Gas	0.25	190	250	[402]
Rack Oven, Gas, Double Rack	0.33	1200	235	[403]
Rack Oven, Gas, Single Rack	0.33	600	235	[403]
Steamer, Electric	0.25	100	105	[403]
Steamer, Gas	0.25	100	105	[404]
Fryer, Electric, Standard	0.25	150	570	[405]
Fryer, Gas, Standard	0.25	150	570	[405]
Griddle, Electric	0.25	100	475	[406]
Griddle, Gas	0.25	100	475	[406]

Peak Factors

Table 3-85 Peak Factors

Peak Factor	Value	Ref
Electric coincidence factor (CF)	0.9	[417]
Natural gas peak day factor (PDF)	See Appendix G: Natural Gas Peak Day Factors	

Measure Life

The effective useful life (EUL) is 12 years⁸⁰.

⁷⁸ Assumes 3-foot griddle width, 2-foot griddle depth

⁷⁹ Assumes 3-foot griddle width, 2-foot griddle depth

⁸⁰ Shared assumption from all PG&E Work Papers referenced in this measure

References

- [396] ENERGY STAR® Commercial Food Service Calculator, <https://www.energystar.gov/buildings/facility-owners-and-managers/existing-buildings/save-energy/purchase-energy-saving-products>
- [397] ENERGY STAR® Program Requirements Product Specification for Commercial Ovens, Eligibility Criteria Version 2.2, October 2015, https://www.energystar.gov/sites/default/files/Commercial%20Ovens%20Final%20Version%202.2%20Specification_0.pdf
- [398] ENERGY STAR® Program Requirements Product Specification for Commercial Steam Cookers, Eligibility Criteria Version 1.2, August 2003, https://www.energystar.gov/sites/default/files/specs//private/Commercial_Steam_Cookers_Program_Requirements%20v1_2.pdf
- [399] ENERGY STAR® Program Requirements Product Specification for Commercial Fryers, Eligibility Criteria Final Draft Version 3.0, October 2016, <https://www.energystar.gov/sites/default/files/ENERGY%20STAR%20Commercial%20Fryers%20Version%203.0%20%28Rev.%20December%20-%202020%29%20Specification.pdf>
- [400] ENERGY STAR® Program Requirements Product Specification for Commercial Griddles, Eligibility Criteria Version 1.2, August 2009, <https://www.energystar.gov/sites/default/files/Commercial%20Griddles%20Version%201.2%20%28Rev%20December%20-%202020%29.pdf>
- [401] Pacific Gas & Electric Company, Work Paper PGECOFST101 Commercial Convection Oven-Electric and Gas, Revision 6, August 2016
- [402] Pacific Gas & Electric Company, Work Paper PGECOFST117 Commercial Conveyor Oven-Gas, Revision 5, May 2014
- [403] Pacific Gas & Electric Company, Work Paper PGECOFST109 Commercial Rack Oven-Gas, Revision 1, October 2018
- [404] Pacific Gas & Electric Company, Work Paper PGECOFST104 Commercial Steam Cooker-Electric and Gas, Revision 6, June 2016
- [405] Pacific Gas & Electric Company, Work Paper PGECOFST102 Commercial Fryer-Electric and Gas, Revision 6, June 2016
- [406] California Technical Forum, Work Paper SWFS004, Commercial Griddle-Electric and Gas, Revision 1, January 2020, available at <http://deeresources.net/workpapers>
- [407] Food Service Technology Center: Gas Rack Oven Life-Cycle Cost Calculator, <https://caenergywise.com/calculators/natural-gas-rack-ovens/#calc>
- [408] Food Service Technology Center: Electric Fryer Life-Cycle Cost Calculator, <https://caenergywise.com/calculators/electric-fryers/#calc>
- [409] Food Service Technology Center: Gas Fryer Life-Cycle Cost Calculator, <https://caenergywise.com/calculators/natural-gas-fryers/#calc>
- [410] California Energy Commission, Energy Research and Development Division, Characterizing the Energy Efficiency Potential of Gas-Fired Commercial Foodservice Equipment, October 2014, <http://www.energy.ca.gov/2014publications/CEC-500-2014-095/CEC-500-2014-095.pdf>
- [411] California Public Utilities Commission, SWFS008, Conveyor Oven, Gas, Commercial, Revision 1, January 2020 available at [Ex Ante Database Archive \(deeresources.net\)](http://Ex_Ante_Database_Archive_(deeresources.net))
- [412] ENERGY STAR® Program Requirements Product Specification for Commercial Fryers, Eligibility Criteria Final Draft Version 2.0, October 2016, https://www.energystar.gov/ia/partners/prod_development/revisions/downloads/commercial_fryers/Final_Version_2.0_Commercial_Fryer_Specification.pdf?6f81-cd61

- [413] California Public Utilities Commission, SWFS001 Commercial Convection Oven – Electric and Gas, Revision 2, May 2020 available at [Ex Ante Database Archive \(deeresources.net\)](#)
- [414] California Public Utilities Commission, SWFS014 Rack Oven, Revision 2, May 2020 available at [Ex Ante Database Archive \(deeresources.net\)](#)
- [415] California Public Utilities Commission, SWFS005 Commercial Steam Cooker, Revision 2, May 2020 available at [Ex Ante Database Archive \(deeresources.net\)](#)
- [416] California Public Utilities Commission, SWFS011 Fryer, Commercial, Revision 4, March 2022 available at [Ex Ante Database Archive \(deeresources.net\)](#)
- [417] New York Standard Approach for Estimating Energy Savings from Energy Efficiency Programs v10, effective date January 1, 2023.

3.4.2 HOLDING CABINETS

Market	Commercial
Baseline Condition	TOS
Baseline	Code
End Use Subcategory	N/A
Measure Last Reviewed	January 2023

Description

This measure covers the installation of ENERGY STAR® qualified electric commercial hot food holding cabinets. A food holding cabinet is a fully enclosed compartment designed to maintain the temperature of hot food that has been cooked in a separate appliance. Half-size, full-size, and large-size holding cabinets are included in this measure. Half-size holding cabinets are defined as any holding cabinet with an internal measured volume of less than 13 ft³. Full-size holding cabinets are defined as any holding cabinet with an internal measured volume of greater than or equal to 15 ft³ and less than or equal to 28 ft³. Large-size holding cabinets are defined as any holding cabinet with an internal measure volume of greater than 28 ft³. This measure does not include cook-and-hold or re-therm equipment.

Baseline Case

The baseline condition is an insulated holding cabinet as defined in the Measure Description above with operating characteristics per Table 3-86.

Efficient Case

The compliance condition is ENERGY STAR® food service equipment as defined in the Measure Description above. Operating characteristics shall be taken from application. When unavailable, default characteristics shall be taken from the Summary of Variables and Data Sources table below. Savings for this measure can be claimed only if there is an increase in the qualifying efficiency from the baseline condition.

Annual Energy Savings Algorithms

Annual Electric Energy Savings

$$\Delta kWh = hrs \times days \times \frac{\Delta W_{idle}}{1,000}$$

Where,

$$\Delta W_{idle} = W_{idle,b} - W_{idle,q}$$

Annual Fuel Savings

$$\Delta Therms = N/A$$

Peak Demand Savings

$$\Delta kW_{Peak} = \frac{\Delta kWh}{hrs \times days} \times CF$$

Daily Peak Fuel Savings

$$\Delta Therms_{Peak} = N/A$$

Lifetime Energy Savings Algorithms

Lifetime Electric Energy Savings

$$\Delta kWh_{Life} = \Delta kWh \times EUL$$

Lifetime Fuel Savings

$$\Delta Therms_{Life} = N/A$$

Calculation Parameters

Table 3-86 Calculation Parameters

Variable	Description	Value	Units	Ref
ΔkWh	Annual electric energy savings	Calculated	kWh/yr	
ΔkW_{Peak}	Peak Demand Savings	Calculated	kW	
ΔkWh_{Life}	Lifetime electric energy savings	Calculated	kWh	
ΔW_{idle}	Daily idle energy savings	Calculated	Watt	
Hrs	Daily operating hours	Site-specific. If unknown, use 15	Hours/day	[420]
Days	Operating days per year	Site-specific. If unknown, see Appendix D: HVAC Fan and Pump Operating Hours	Days/yr	[419]
1,000	Conversion factor, one kW equals 1,000 watts	1,000	Watts	
$W_{idle,b}$	Baseline equipment idle energy rate by volume	Look up in Table 3-87	Watts	[421]
$W_{idle,q}$	Energy efficient equipment idle energy rate by volume	Site-specific	Watts	
V	Volume of holding cabinet	Site-specific. If unknown, look up in Table 3-87	ft ³	[422]
CF	Electric coincidence factor	Look up in Table 3-88	N/A	
PDF	Gas peak day factor	Look up in Table 3-88	N/A	
EUL	Effective useful life	See Measure Life Section	Years	

Table 3-87 Default Values

Equipment	$W_{idle,b}$	V
Insulated Holding Cabinet, Large-Size ($28 \leq V$)	$3.8v + 203.5$	35
Insulated Holding Cabinet, Full-Size ($13 \leq V < 28$)	$2v + 254$	25
Insulated Holding Cabinet, Half-Size ($0 < V < 13$)	$21.5v$	10

Peak Factors**Table 3-88 Peak Factors**

Peak Factor	Value	Ref
Electric coincidence factor (CF)	0.9	[420]
Natural gas peak day factor (PDF)	N/A	

Measure Life

The effective useful life (EUL) is 12 years [418].

References

- [418] DEER 2014 EUL IDs: Various.
http://www.deeresources.com/files/DEER2013codeUpdate/download/DEER2014-EUL-table-update_2014-02-05.xlsx
- [419] California Energy Commission, Characterizing the Energy Efficiency Potential of Gas-Fired Commercial Foodservice Equipment, Appendix E.
- [420] PG&E Work Paper PGECOFST105 Revision 5, pg. 7. Available to download at
<http://deeresources.net/workpapers>
- [421] ENERGY STAR® Program Requirements for Commercial Hot Food Holding Cabinets, Eligibility Criteria Version 2.0, July 2011, where v is holding cabinet volume (ft³).
https://www.energystar.gov/sites/default/files/asset/document/Commercial_HFHC_Program_Requirements_2.0.pdf#:~:text=ENERGY%20STAR%C2%AE%20Program%20Requirements%20Product%20Specification%20for%20Commercial,has%20also%20been%20changed%20from%202010%20to%202011.
- [422] PG&E Work Paper PGECOFST105 Revision 5, Table 6, pg. 5.

3.4.3 DISHWASHERS

Market	Commercial
Baseline Condition	TOS
Baseline	Code
End Use Subcategory	N/A
Measure Last Reviewed	January 2023

Description

This measure describes the installation of ENERGY STAR qualified, high-efficiency stationary and conveyor-type commercial dishwashers used in commercial kitchen establishments that use non-disposable dishes, glassware, and utensils. Commercial dishwashers can clean and sanitize a large quantity of kitchenware in a short amount of time by utilizing hot water, soap, rinse chemicals, and significant amounts of energy. ENERGY STAR qualified models use less water and have lower idling rates than non-ENERGY STAR rated models.

The savings derived below are heavily dependent on the assumed dishwasher hours of operation, which are consistent with a high-usage restaurant or cafeteria operation. If dishwashers are found to be installed in applications with significantly different hours of operation, the hours and savings shall be revised in a custom calculation.

This measure is not applicable to flight machines, which are continuous conveyor machines built specifically for large institutions.

Baseline Case

This is defined as a time of sale measure. The baseline condition is a commercial dishwasher meeting ENERGY STAR Version 2.0 requirements.[423]

Efficient Case

The efficient condition is a high-efficiency commercial dishwasher meeting ENERGY STAR Version 3.0 requirements. [424]

Annual Energy Savings Algorithms

Annual Electric Energy Savings

$$\Delta kWh = \Delta kWh_{WaterHeater} + \Delta kWh_{BoosterHeater} + \Delta kWh_{Idle}$$

Where,

$$\Delta kWh_{WaterHeater} = (WU_b - WU_q) \times RW \times Days \times \frac{\Delta T_{in} \times 1.0 \times 8.2}{RE \times 3,412}$$

$$\Delta kWh_{BoosterHeater} = (WU_b - WU_q) \times RW \times Days \times \frac{\Delta T_{in} \times 1.0 \times 8.2}{RE \times 3,412}$$

$$\Delta kWh_{Idle} = \left(kW_b \times Days \times \left(HD - \frac{RW \times WT}{60} \right) \right) - \left(kW_q \times Days \times \left(HD - \frac{RW \times WT}{60} \right) \right)$$

Annual Fuel Savings

$$\Delta Therms = \Delta Therms_{WaterHeater} = (WU_b - WU_q) \times RW \times Days \times \frac{\Delta T_{in} \times 1.0 \times 8.2}{RE \times 100,000}$$

Peak Demand Savings

$$\Delta kW_{Peak} = \Delta kWh \times \frac{CF}{HD \times Days}$$

Daily Peak Fuel Savings

$$\Delta Therms_{Peak} = \Delta Therms \times PDF$$

Lifetime Energy Savings Algorithms

Lifetime Electric Energy Savings

$$\Delta kWh_{Life} = \Delta kWh \times EUL$$

Lifetime Fuel Savings

$$\Delta Therms_{Life} = \Delta Therms \times EUL$$

Calculation Parameters

Table 3-89 Calculation Parameters

Variable	Description	Value	Units	Ref
ΔkWh	Annual electric energy savings	Calculated	kWh/yr	
$\Delta Therms$	Annual fuel savings	Calculated	Therms/yr	
ΔkW_{Peak}	Peak Demand Savings	Calculated	kW	
$\Delta Therms_{Peak}$	Daily peak fuel savings	Calculated	Therms/day	
ΔkWh_{Life}	Lifetime electric energy savings	Calculated	kWh	
$\Delta Therms_{Life}$	Lifetime fuel savings	Calculated	Therms	
$\Delta kWh_{WaterHeater}$	Annual water heater electric energy savings	Calculated	kWh/yr	
$\Delta kWh_{BoosterHeater}$	Annual booster heater electric energy savings	Calculated	kWh/yr	
ΔkWh_{Idle}	Annual dishwasher idle electric energy savings	Calculated	kWh/yr	
WU_q	Water use per rack of qualifying dishwasher, varies by machine type and sanitation method	Site-specific	Gallons	
kW_q	Idle power draw of ENERGY STAR 3.0 dishwasher, varies by machine type and sanitation method	Site-specific	kW	

Variable	Description	Value	Units	Ref
Days	Annual days of dishwasher consumption per year	Site-specific, if unknown use 365	Days/Year	[423]
WU _b	Water use per rack of baseline dishwasher, varies by machine type and sanitation method	Look up in Table 3-90	Gallons	[424]
RW	Number of racks washed per day, varies by machine type and sanitation method	Look up in Table 3-90	Racks Washed/Day	[423]
ΔT _{in}	Temperature rise in water delivered by building water heater or booster water heater, value varies by type of water heater source	Building WH = 70 Booster WH = 40	°F	[423]
RE	Recovery efficiency of water heater	Site-specific, if unknown use 0.98 for electric and 0.80 for gas		[423]
kW _b	Idle power draw of baseline dishwasher, varies by machine type and sanitation method	Look up in Table 3-90	kW	[424]
HD	Hours per day of dishwasher operation	Site-specific, if unknown use 18 hours/day	Hours/Day	[423]
WT	Wash time per dishwasher, varies by machine type and sanitation method	Look up in Table 3-90	Minutes	[423]
H2O _b	Annual water consumption of baseline unit	Look up in Table 3-91	gallons	[423]
H2O _q	Annual water consumption of efficient unit	Look up in Table 3-91	gallons	[423]
8.2	Density of Water	8.2	Lbs/gal	[425]
60	Conversion factor	60	Min/hr	
3,412	Conversion factor	3,412	Btu/kWh	
1.0	Conversion factor	1.0	Btu/lb-°F	
100,000	Conversion factor	100,000	Btu/therm	
CF	Electric coincidence factor	Look up in Table 3-92	N/A	[426]
PDF	Gas peak day factor	Look up in Table 3-92	N/A	
EUL	Effective useful life	See	Years	

Table 3-90 Default Inputs for ENERGY STAR 2.0 Commercial Dishwasher

Machine Type	Temperature	WU _{base}	RW	WT	kW _{base}
Under Counter	Low	1.19	75	2.0	0.50
Stationary Single Tank Door		1.18	280	1.5	0.60
Single Tank Conveyor		0.79	400	0.3	1.50
Multi Tank Conveyor		0.54	600	0.3	2.00

Machine Type	Temperature	WU_{base}	RW	WT	kW_{base}
Under Counter	High	0.86	75	2.0	0.5
Stationary Single Tank Door		0.89	280	1.0	0.7
Single Tank Conveyor		0.70	400	0.3	1.5
Multi Tank Conveyor		0.54	600	0.2	2.25
Pot, Pan, and Utensil		0.58	280	3.0	1.20

Table 3-91 Annual Water Consumption

Machine Type	Temperature	$H2O_b$	$H2O_q$
Under Counter	Low	47,359	32,576
Stationary Single Tank Door		214,620	120,596
Single Tank Conveyor		191,260	115,340
Multi Tank Conveyor		227,760	118,260
Under Counter	High	29,839	23,543
Stationary Single Tank Door		131,838	90,958
Single Tank Conveyor		127,020	102,200
Multi Tank Conveyor		212,430	118,260
Pot, Pan, and Utensil		71,540	59,276

Peak Factors

Table 3-92 Peak Factors

Peak Factor	Value	Ref
Electric coincidence factor (CF)	0.9	[426]
Natural gas peak day factor (PDF)	See	

Non-Energy Impacts

$$\Delta H2O = H2O_b - H2O_q$$

Measure Life

The effective useful life (EUL) is listed in Table 3-93 [423].

Table 3-93 Measure Life

Machine Type	Measure Life (years)
Under Counter	10
Stationary Single Tank Door	15
Single Tank Conveyor	20
Multi Tank Conveyor	20
Pot, Pan, and Utensil	10

References

- [423] ENERGY STAR Savings Calculator for Certified Commercial Kitchen Equipment.
http://www.energystar.gov/buildings/sites/default/uploads/files/commercial_kitchen_equipment_calculator.xlsx
- [424] ENERGY STAR Program Requirements for Commercial Dishwashers Version 2.0, ENERGY STAR, February 2013.
- [425] Dishwasher inlet temperature assumed at 140 degrees F. <https://water.usgs.gov/edu/density.html>.
- [426] New York Standard Approach for Estimating Energy Savings from Energy Efficiency Programs v10, effective date January 1, 2023.

3.4.4 ICE MACHINES

Market	Commercial
Baseline Condition	TOS/DI
Baseline	Code/Dual
End Use Subcategory	N/A
Measure Last Reviewed	January 2023

Description

This measure covers the installation of ENERGY STAR® qualified ice makers. Ice makers are factory-made assemblies consisting of a condensing unit and ice-making section operating as an integrated unit, with means for making and harvesting ice. This measure includes batch-type (cube type) and continuous-type (flake or nugget type) ice makers. Batch-type ice makers have distinct freezing and harvesting periods whereas continuous-type ice makers produce ice through a continuous freezing and harvesting process. Ice makers that have earned the ENERGY STAR® label use approximately 11% less energy and 25% less water than comparable non-qualified models [427].

This measure covers ice making head, remote condensing, and self-contained air-cooled ice makers. Water-cooled ice makers, ice and water dispensing systems, and air-cooled remote condensing units that are designed only for connection to remote rack compressors are not eligible for energy savings.

Baseline Case

The baseline condition is a commercial ice maker as defined in the Measure Description section above with Equipment Type and Ice Harvest Rate equivalent to the efficient case. Baseline daily energy use per 100 lbs of ice shall be established based on efficient equipment Ice Harvest Rate in accordance with current federal standards for batch type [428] and continuous type [428] ice makers, as specified in the Code of Federal Regulations and provided in Table 3-95.

Efficient Case

The compliance condition is an ENERGY STAR® version 3.0 qualified commercial ice maker as defined in the Measure Description above. Efficient condition daily energy use per 100 pounds of ice are established based on efficient equipment Ice Harvest Rate in accordance with ENERGY STAR® v. 3.0 maximum qualifying specifications, as shown in Table 3-95 [429]. An efficient ice maker also needs to meet the potable water consumption requirement as shown in Table 3-95 [429].

Annual Energy Savings Algorithms

Annual Electric Energy Savings

$$\Delta kWh = (kWh_b - kWh_q) \times 365 \times Cycle \times \left(\frac{IHR}{100}\right)$$

Annual Fuel Savings

$$\Delta Therms = N/A$$

Peak Demand Savings

$$\Delta kW_{Peak} = \frac{\Delta kWh}{8,760 \times Cycle} \times CF$$

Daily Peak Fuel Savings

$$\Delta Therms_{Peak} = N/A$$

Lifetime Energy Savings Algorithms

Lifetime Electric Energy Savings

$$\Delta kWh_{Life} = \Delta kWh \times EUL$$

Lifetime Fuel Savings

$$\Delta Therms_{Life} = N/A$$

Dual:

Lifetime Electric Energy Savings

$$\Delta kWh_{Life} = \Delta kWh_{EREP} \times RUL + \Delta kWh_{NR} \times EUL$$

Lifetime Fuel Savings

$$\Delta Therms_{Life} = N/A$$

Calculation Parameters

Table 3-94 Calculation Parameters

Variable	Description	Value	Units	Ref
ΔkWh	Annual electric energy savings	Calculated	kWh/yr	
ΔkW_{Peak}	Peak Demand Savings	Calculated	kW	
ΔkWh_{Life}	Lifetime electric energy savings	Calculated	kWh	
kWh_b	Baseline electric energy consumption per 100 pounds of ice	Look up in Table 3-95	kWh/lbs	[428]
kWh_q	Energy efficient electric energy consumption per 100 pounds of ice	Site-specific. If unknown, look up in Table 3-95	kWh/lbs	[429]
IHR	Rated Ice Harvest Rate of the energy efficient measure	Site-specific	lbs/day	

Variable	Description	Value	Units	Ref
Cycle	Duty cycle, defined as the ratio of the actual ice harvest rate to the equipment rated ice harvest rate	0.75	N/A	[431]
365	Days per year	365	Days/yr	
100	Factor to convert IHR to units of 100 lbs/day	100	lbs/day	
8,760	Hours in one year	8,760	Hrs/yr	
CF	Electric coincidence factor	Look up in Table 3-96	N/A	[430]
PDF	Gas peak day factor	Look up in Table 3-96	N/A	
EUL	Effective useful life	See Measure Life Section	Years	[432]
RUL	Remaining useful life of existing unit	See Measure Life Section	Years	

Table 3-95 Equipment Type and Ice Harvest Rate

Equipment Type	Ice Harvest Rate (IHR)	Baseline Daily Energy Use per 100 ilbs (kWh _b)	Measure Daily Energy Use per 100 lbs (kWh _q)	Potable Water Use (gal/100 lbs ice)
Batch Type, Ice-Making Head	< 300	$10 - 0.01233 \times \text{IHR}$	$9.20 - 0.01134 \times \text{IHR}$	≤ 20.0
	≥ 300 and < 800	$7.05 - 0.0025 \times \text{IHR}$	$6.49 - 0.0023 \times \text{IHR}$	≤ 20.0
	≥ 800 and $< 1,500$	$5.55 - 0.00063 \times \text{IHR}$	$5.11 - 0.00058 \times \text{IHR}$	≤ 20.0
	$\geq 1,500$ and $< 4,000$	4.61	4.24	≤ 20.0
Batch Type, Remote Condensing	< 988	$7.97 - 0.00342 \times \text{IHR}$	$7.17 - 0.00308 \times \text{IHR}$	≤ 20.0
	≥ 988 and $< 4,000$	4.59	4.13	≤ 20.0
Batch Type, Self-Contained	< 110	$14.79 - 0.0469 \times \text{IHR}$	$12.57 - 0.0399 \times \text{IHR}$	≤ 25.0
	≥ 110 and < 200	$12.42 - 0.02533 \times \text{IHR}$	$10.56 - 0.0215 \times \text{IHR}$	≤ 25.0
	≥ 200 and $< 4,000$	7.35	6.25	≤ 25.0
Continuous Type, Ice-Making Head	< 310	$9.19 - 0.00629 \times \text{IHR}$	$7.90 - 0.005409 \times \text{IHR}$	≤ 15.0
	≥ 310 and < 820	$8.23 - 0.0032 \times \text{IHR}$	$7.08 - 0.002752 \times \text{IHR}$	≤ 15.0
	≥ 820 and $< 4,000$	5.61	4.82	≤ 15.0
Continuous Type, Remote Condensing	< 800	$9.7 - 0.0058 \times \text{IHR}$	$7.76 - 0.00464 \times \text{IHR}$	≤ 15.0
	≥ 800 and $< 4,000$	5.06	4.05	≤ 15.0
Continuous Type, Self-Contained	< 200	$14.22 - 0.03 \times \text{IHR}$	$12.37 - 0.0261 \times \text{IHR}$	≤ 15.0
	≥ 200 and < 700	$9.47 - 0.00624 \times \text{IHR}$	$8.24 - 0.005429 \times \text{IHR}$	≤ 15.0
	≥ 700 and $< 4,000$	5.1	4.44	≤ 15.0

Peak Factors

Table 3-96 Peak Factors

Peak Factor	Value	Ref
Electric coincidence factor (CF)	0.9	[430]
Natural gas peak day factor (PDF)	N/A	

Measure Life

The remaining useful life (RUL) for existing equipment is limited to 1/3 of the effective useful life (EUL) of the equipment.

Table 3-97 Measure Life

Equipment	EUL	RUL	Ref
Ice Machines	10	3.3	[432]

References

- [427] “Commercial Ice Maker Key Product Criteria.” n.d. www.energystar.gov. Accessed January 17, 2023. https://www.energystar.gov/products/commercial_food_service_equipment/commercial_ice_makers/key_product_criteria
- [428] “10 CFR § 431.136 (c) and (d) - Energy Conservation Standards and Their Effective Dates.” n.d. LII / Legal Information Institute. Accessed January 17, 2023. <https://www.law.cornell.edu/cfr/text/10/431.136>
- [429] “ENERGY STAR Program Requirements for Automatic Commercial Ice Makers -Partner Commitments ENERGY STAR® Program Requirements for Automatic Commercial Ice Makers Partner Commitments.” n.d. Accessed January 17, 2023. https://www.energystar.gov/sites/default/files/Final%20V3.0%20ACIM%20Specification%205-17-17_1.pdf
- [430] Pacific Gas & Electric Work Paper SWFS SWFS006-01 Commercial Ice Machines, January 2020, pg. 12. www.deeresources.net/workpapers
- [431] Pacific Gas & Electric Work Paper SWFS SWFS006-01 Commercial Ice Machines, January 2020, pg. 9. www.deeresources.net/workpapers
- [432] Pacific Gas & Electric Work Paper SWFS SWFS006-01 Commercial Ice Machines, January 2020, pg. 11. www.deeresources.net/workpapers

3.5 HVAC

3.5.1 CENTRAL AC, AIR SOURCE HEAT PUMPS, MINI-SPLITS, PTAC, PTHP

Market	Commercial/Multifamily
Baseline Condition	TOS/NC/EREP/DI
Baseline	Code/Dual
End Use Subcategory	Equipment
Measure Last Reviewed	January 2023

Description

This prescriptive measure targets the use of central air conditioners, air source heat pumps, mini split heat pumps, packaged terminal systems (PTAC and PTHP) in commercial and multifamily high-rise applications as further described below. This measure may apply to early replacement of an existing system, replacement on burnout, or installation of a new unit in a new or existing commercial or multifamily high-rise building for HVAC applications.

Baseline Case

For whole building new construction, the baseline equipment is an industry standard equipment type for the facility compliant with ASHRAE 90.1-2019 (see Appendix E: Code-Compliant Efficiencies).

For replacement of failed equipment, or end of useful life, the baseline would be a minimally code compliant version of the replaced system type and fuel.

For early replacement projects, use dual baselines:

- For the remaining useful life (RUL) of the existing equipment, the baseline is the actual existing equipment. In the lifetime algorithms section, annual savings for this period are designated as kWh_{ex} and Therms_{ex}. If the site specific efficiency of the existing equipment is unknown, use the equipment efficiency from the ASHRAE 90.1 version in force when the equipment was new (if equipment vintage is unknown, use ASHRAE 90.1 2013 efficiency requirements from Appendix E: Code-Compliant Efficiencies).
- For the duration of the measure life after the end of the RUL, the baseline is a code-compliant version of the replaced equipment. In the lifetime algorithms section, annual savings for this period are designated as kWh_{NR} and Therms_{NR}.

Efficient Case

A central air conditioner, air source heat pump, mini split heat pump, or packaged terminal system (PTAC and PTHP) that meets ENERGY STAR Light Commercial HVAC v4.0 criteria [433], or otherwise exceeds ASHRAE 90.1-2019 requirements if not included in ENERGY STAR specification.

Annual Energy Savings Algorithms

Annual Electric Energy Savings

$$\Delta kWh = kWh_b - kWh_q$$

Where,

$$kWh_b = OSF \times kWh_{c,b} + kWh_{h,b}$$

$$kWh_q = OSF \times kWh_{c,q} + kWh_{h,q}$$

Calculate $kWh_{c,b}$ and $kWh_{h,b}$ using the algorithms in Table 3-98 for the appropriate baseline equipment type. Calculate $kWh_{c,q}$ and $kWh_{h,q}$ using the algorithms in Table 3-99 for the appropriate efficient equipment type.

Table 3-98 Baseline Energy Consumption Equations

Baseline Equipment	Baseline Cooling kWh ($kWh_{c,b}$)	Baseline Heating kWh ($kWh_{h,b}$)
Mini-split heat pump, ASHP (Cooling Capacity < 65 kBtu/h)	$\frac{Cap_c}{SEER_b \times 1,000} \times EFLH_c$	$\frac{Cap_h}{HSPF_b \times 1,000} \times EFLH_h$
ASHP (Cooling Capacity > 65 kBtu/h & IEER Available)	$\frac{Cap_c}{IEER_b \times 1,000} \times EFLH_c$	$\frac{Cap_h}{COP_b \times 3.412 \times 1,000} \times EFLH_h$
ASHP (Cooling Capacity > 65 kBtu/h & IEER not available)	$\frac{Cap_c}{EER_b \times 1,000} \times EFLH_c$	$\frac{Cap_h}{COP_b \times 3.412 \times 1,000} \times EFLH_h$
Air Conditioner (Cooling Capacity < 65 kBtu/h)	$\frac{Cap_c}{SEER_b \times 1,000} \times EFLH_c$	0
Air Conditioner (Cooling Capacity > 65 kBtu/h & IEER Available)	$\frac{Cap_c}{IEER_b \times 1,000} \times EFLH_c$	0
Air Conditioner (Cooling Capacity > 65 kBtu/h & IEER not available)	$\frac{Cap_c}{EER_b \times 1,000} \times EFLH_c$	0
PTAC	$\frac{Cap_c}{EER_b \times 1,000} \times EFLH_c$	0
PTHP	$\frac{Cap_c}{EER_b \times 1,000} \times EFLH_c$	$\frac{Cap_h}{COP_b \times 3.412 \times 1,000} \times EFLH_h$
Electric Resistance heating	0	$\frac{Cap_h}{HSPF_b \times 1,000} \times EFLH_h$
Room Air Conditioner	$\frac{Cap_c}{CEER_b \times 1,000} \times EFLH_c$	0

Table 3-99 Energy Efficient Energy Consumption Equations

Qualifying Equipment	Efficient Cooling kWh ($kWh_{c,q}$)	Efficient Heating kWh ($kWh_{h,q}$)
Mini-split heat pump, ASHP (Cooling Capacity < 65 kBtu/h)	$\frac{Cap_c}{SEER_q \times 1,000} \times EFLH_c$	$\frac{Cap_h}{HSPF_q \times 1,000} \times EFLH_h$

Qualifying Equipment	Efficient Cooling kWh (kWh _{c,q})	Efficient Heating kWh (kWh _{h,q})
ASHP (Cooling Capacity > 65 kBtu/h & IEER Available)	$\frac{Cap_c}{IEER_q \times 1,000} \times EFLH_c$	$\frac{Cap_h}{COP_q \times 3,412 \times 1,000} \times EFLH_h$
ASHP (Cooling Capacity > 65 kBtu/h & IEER not available)	$\frac{Cap_c}{EER_q \times 1,000} \times EFLH_c$	$\frac{Cap_h}{COP_q \times 3,412 \times 1,000} \times EFLH_h$
Central Air Conditioner (Cooling Capacity < 65 kBtu/h)	$\frac{Cap_c}{SEER_q \times 1,000} \times EFLH_c$	0
Central Air Conditioner (Cooling Capacity > 65 kBtu/h & IEER Available)	$\frac{Cap_c}{IEER_q \times 1,000} \times EFLH_c$	0
Central Air Conditioner (Cooling Capacity > 65 kBtu/h & IEER not available)	$\frac{Cap_c}{EER_q \times 1,000} \times EFLH_c$	0
PTAC	$\frac{Cap_c}{EER_q \times 1,000} \times EFLH_c$	0
PTHP	$\frac{Cap_c}{EER_q \times 1,000} \times EFLH_c$	$\frac{Cap_h}{COP_q \times 3,412 \times 1,000} \times EFLH_h$

Annual Fuel Savings

$$\Delta Therms = Therms_b - Therms_q$$

Where,

$Therms_b =$ see Table 3-106 for appropriate baseline equipment type

$$Therms_q = 0$$

Table 3-100 Fuel Savings

Baseline Equipment	Baseline fuel consumption (Therms _b)
ASHP	0
Gas Fired Furnace/Boiler	$\frac{Cap_h}{Eff_{b,fuel} \times 100,000} \times EFLH_h$
Electric resistance heating	0

Peak Demand Savings

$$\Delta kW_{Peak} = Cap_c \times \frac{1}{1,000} \times \left(\frac{1}{EER_b} - \frac{1}{EER_q} \right) \times CF_c$$

Daily Peak Fuel Savings

$$\Delta Therms_{Peak} = \Delta Therms \times PDF$$

Lifetime Energy Savings Algorithms

Lifetime Electric Energy Savings

No dual baseline:

$$\Delta kWh_{Life} = \Delta kWh \times EUL$$

Dual baseline:

$$\Delta kWh_{Life} = \Delta kWh_{Ex} \times RUL + \Delta kWh_{NR} \times (EUL - RUL)$$

Where,

ΔkWh_{Ex} = annual energy savings calculated as above, using actual existing equipment baseline

ΔkWh_{NR} = annual energy savings calculated as above, using code baseline

Lifetime Fuel Savings

No dual baseline:

$$\Delta Therms_{Life} = \Delta Therms \times EUL$$

Dual baseline:

$$\Delta Therms_{Life} = \Delta Therms_{Ex} \times RUL + \Delta Therms_{NR} \times (EUL - RUL)$$

Where,

$\Delta Therms_{Ex}$ = annual fuel savings calculated as above, using actual existing equipment baseline

$\Delta Therms_{NR}$ = annual fuel savings calculated as above, using code baseline

Calculation Parameters

Table 3-101 Calculation Parameters

Variable	Description	Value	Units	Ref
ΔkWh	Annual electric energy savings	Calculated	kWh/yr	
$\Delta Therms$	Annual fuel savings	Calculated	Therms/yr	
ΔkW_{Peak}	Peak Demand Savings	Calculated	kW	
$\Delta Therms_{Peak}$	Daily peak fuel savings	Calculated	Therms/day	
ΔkWh_{Life}	Lifetime electric energy savings	Calculated	kWh	
$\Delta Therms_{Life}$	Lifetime fuel savings	Calculated	Therms	
kWh_b	Baseline electrical consumption	Calculated	kWh/yr	

Variable	Description	Value	Units	Ref
kWh _q	Energy efficient electrical consumption	Calculated	kWh/yr	
Cap _c	Cooling capacity of installed unit	Site-specific	Btu/hr	
Cap _h	Heating capacity of installed unit	Site-specific	Btu/hr	
SEER _q	SEER of installed unit	Site-specific	Btu/W-h	
IEER _q	IEER of qualifying unit	Site-specific	Btu/W-h	
EER _q	EER of qualifying unit	Site-specific	Btu/W-h	
COP _q	Coefficient of performance at 47F of the qualifying unit	Site-specific	N/A	
HSPF _q	Heating seasonal performance factor of the installed unit	Site-specific	Btu/W-h	
SEER _b	SEER of baseline unit	Site-specific, if unknown look up in Appendix E: Code-Compliant Efficiencies	Btu/W-h	[433][435]
IEER _b	IEER of baseline unit	Site-specific, if unknown look up in Appendix E: Code-Compliant Efficiencies	Btu/W-h	[433][435]
EER _b	EER of baseline unit	Site-specific, if unknown look up in Appendix E: Code-Compliant Efficiencies	Btu/W-h	[433][435]
HSPF _b	Heating seasonal performance factor of the baseline unit	Site-specific, if unknown look up in Appendix E: Code-Compliant Efficiencies. For electric resistance heat, use 3.412	Btu/W-h	[433][435]
CEER _b	Combined Energy Efficiency Ratio of baseline room air conditioner ⁸¹	Use federal standard values in Appendix E: Code-Compliant Efficiencies. If unknown, use 11.0	Btu/W-h	[439]
Eff _{b,fuel}	Efficiency of baseline boiler/furnace	Site-specific, if unknown look up in Appendix E: Code-Compliant Efficiencies	N/A	[433][435]
OSF	Oversize derating factor ⁸²	Site-specific, if unknown use 0.8	N/A	
kWh _{c,b}	Baseline cooling electrical consumption	Look up in Table 3-98	kWh/yr	
kWh _{h,b}	Baseline heating electrical consumption	Look up in Table 3-98	kWh/yr	

⁸¹ Default value (11.0) is the CEER value from minimum Federal Standard for the most common room AC type – <8000 capacity range with louvered sides

⁸² Heat pump systems may be sized to meet the peak heating load and will be oversized for cooling. The cooling EFLH assumes a nominal 20% oversizing. This derating factor has been added to account for the oversizing of heat pump cooling capacity when the unit is sized based on heating capacity. A user with a more accurate estimation of the oversizing can use a different factor than the one mentioned above to account for oversizing.

Variable	Description	Value	Units	Ref
kWh _{c,q}	Energy efficient cooling electrical consumption	Look up in Table 3-99	kWh/yr	
kWh _{h,q}	Energy efficient heating electrical consumption	Look up in Table 3-99	kWh/yr	
Therms _b	Baseline fuel consumption	Look up in Table 3-100	Therms/yr	
Therms _q	Energy efficient fuel consumption	0	Therms/yr	
EFLH _c	Equivalent Full Load Hours of operation for the average unit during the cooling season	See Appendix C:	Hours	[436]
EFLH _h	Equivalent Full Load Hours of operation for the average unit during the heating season	See Appendix C:	Hours	[436]
COP _b	Coefficient of performance at 47F of the baseline unit	Look up in Appendix E: Code-Compliant Efficiencies	N/A	[433][435]
1,000	Conversion from hp to Kw	1,000	w/kW	
3.412	Conversion factor from kWh to kBtu	3.412	kBtu/kWh	
CF	Cooling coincidence factor	Look up in Table 3-102	N/A	[437]
PDF	Gas peak day factor	Look up in Table 3-102	N/A	
EUL	Effective useful life	See Measure Life Section	Years	[438]

Peak Factors

Table 3-102 Peak Factors

Peak Factor	Value	Ref
Electric coincidence factor (CF)	0.5	[437]
Natural gas peak day factor (PDF)	See Appendix G: Natural Gas Peak Day Factors	

Measure Life

The remaining useful life (RUL) for existing equipment is limited to 1/3 of the effective useful life (EUL) of the equipment.

Table 3-103 Measure Life

Equipment	EUL	RUL	Ref
Central A/C	15	5	[438]
Air source heat pump	15	5	[438]
Mini split heat pump	15	5	[438]
PTAC/PTHP	15	5	[438]

References

- [433] ENERGY STAR Light Commercial HVAC Version 4.0, https://www.energystar.gov/sites/default/files/asset/document/ENERGY%20STAR%20LC%20HVAC%20Version%204.0%20Specification%20Rev%20April%202022.pdf?_gl=1*n9oet2*_ga*MTUwMjg5MDYyNC4xNjY0NDc5NDA0*_ga_SOKJTVVLQ6*MTY4MDU0Njc4Ni4zNS4xLjE2ODA1NDY5NjAuMC4wLjA
- [434] ASHRAE Standard 90.1-2019, Energy Standard for Buildings Except Low-Rise Residential Buildings. (ASHRAE, 2019), Table 6.8.1-5, <https://www.ashrae.org/technical-resources/standards-and-guidelines/read-only-versions-of-ashrae-standards>
- [435] ASHRAE Standard 90.1-2013, Energy Standard for Buildings Except Low-Rise Residential Buildings. (ASHRAE, 2019), Table 6.8.1-5, <https://www.ashrae.org/technical-resources/standards-and-guidelines/read-only-versions-of-ashrae-standards>
- [436] Simulations of prototype buildings from NY TRM updated with NJ weather done by NJ Statewide Evaluator, May 2022
- [437] C&I Unitary HVAC Load Shape Project Final Report. August 2011, v.1.1, p. 12, Table O-5. The CF reported here is a center point for NJ chosen between the CF for urban NY and for the Mid-Atlantic region in the PJM peak periods.
- [438] California Public Utilities Commission Database for Energy Efficient Resources (DEER) EUL Support Table for 2020, <http://www.deeresources.com/files/DEER2020/download/SupportTable-EUL2020.xlsx>
- [439] Code of Federal Regulations. 2022. Review of Title 10, Chapter II, Subchapter D, Part 430, Subpart C, section 430.32 b) Room Air Conditioners,

3.5.2 GEOTHERMAL AND WATER SOURCE HEAT PUMPS

Market	Commercial/Multifamily
Baseline Condition	TOS/NC/NR/EREP/DI
Baseline	Code/Dual
End Use Subcategory	Equipment
Measure Last Reviewed	January 2022

Description

This prescriptive measure targets the use of, water to air water loop heat pumps, water to air ground water heat pumps, brine to air ground loop heat pumps, brine to water ground loop heat pumps in commercial and multifamily applications as further described below. This measure may apply to early replacement of an existing system, replacement on burnout, or installation of a new unit in a new or existing commercial or multifamily building for HVAC applications.

Baseline Case

For whole building new construction, the baseline equipment is an air source heat pump (or other industry standard equipment type for the facility) compliant with ASHRAE 90.1-2019 (see Appendix E: Code-Compliant Efficiencies).

For replacement of failed equipment, or end of useful life, the baseline would be a minimally code compliant version of the replaced system type and fuel.

For early replacement projects, use dual baselines:

- For the remaining useful life (RUL) of the existing equipment, the baseline is the actual existing equipment. In the lifetime algorithms section, annual savings for this period are designated as kWh_{ex} and Therms_{ex}. If the site specific efficiency of the existing equipment is unknown, use the equipment efficiency from the ASHRAE 90.1 version in force when the equipment was new (if equipment vintage is unknown, use ASHRAE 90.1 2013 efficiency requirements from Appendix E: Code-Compliant Efficiencies).
- For the duration of the measure life after the end of the RUL, the baseline is a current code-compliant version of the replaced equipment. In the lifetime algorithms section, annual savings for this period are designated as kWh_{NR} and Therms_{NR}.
- Note: the algorithms in this section assume that the installed heat pump replaces 100% of the heating and cooling load of the existing equipment. In a partial displacement scenario, the consumption algorithms must be adjusted to account for the actual percent of building load supplied by HVAC equipment.

Efficient Case

A high-efficiency groundwater source, water source, or ground source heat pump system that meets or exceeds code requirements.

Annual Energy Savings Algorithms

Annual Electric Energy Savings

$$\Delta kWh = kWh_b - kWh_q$$

Where,

$$kWh_b = OSF \times kWh_{c,b} + kWh_{h,b} + kWh_{p,b}$$

$$kWh_q = OSF \times kWh_{c,q} + kWh_{h,q} + kWh_{p,q}$$

Calculate $kWh_{c,b}$, $kWh_{h,b}$, and $kWh_{p,b}$ using the algorithms in Table 3-104 for the appropriate baseline equipment type.

Calculate $kWh_{c,q}$, $kWh_{h,q}$, and $kWh_{p,q}$ using the algorithms in Table 3-105 for the appropriate efficient equipment type.

Table 3-104 Baseline Energy Consumption Equations

Baseline Equipment	Baseline Cooling kWh ($kWh_{c,b}$)	Baseline Heating kWh ($kWh_{h,b}$)	Baseline Circulating Pump kWh ($kWh_{p,b}$)
ASHP (Cooling Capacity < 65 kBtu/h)	$\frac{Cap_c}{SEER_b \times 1,000} \times EFLH_c$	$\frac{Cap_h}{HSPF_b \times 1,000} \times EFLH_h$	0
ASHP (Cooling Capacity > 65 kBtu/h & IEER Available)	$\frac{Cap_c}{IEER_b \times 1,000} \times EFLH_c$	$\frac{Cap_h}{COP_b \times 3.412 \times 1,000} \times EFLH_h$	0
ASHP (Cooling Capacity > 65 kBtu/h & IEER not available)	$\frac{Cap_c}{EER_b \times 1,000} \times EFLH_c$	$\frac{Cap_h}{COP_b \times 3.412 \times 1,000} \times EFLH_h$	0
WSHP	$\frac{Cap_c}{EER_b \times 1,000} \times EFLH_c$	$\frac{Cap_h}{COP_b \times 3.412 \times 1,000} \times EFLH_h$	$\frac{0.746 \times HP_b \times LF}{Eff_b} \times Hr$
GSHP (Cooling Capacity < 65 kBtu/h)	$\frac{Cap_c}{GSER \times EER_b \times 1,000} \times EFLH_c$	$\frac{Cap_h}{HSPF_b \times 1,000} \times EFLH_h$	$\frac{0.746 \times HP_b \times LF}{Eff_b} \times Hr$
GSHP (Cooling Capacity > 65 kBtu/h)	$\frac{Cap_c}{EER_b \times 1,000} \times EFLH_c$	$\frac{Cap_h}{COP_b \times 3.412 \times 1,000} \times EFLH_h$	$\frac{0.746 \times HP_b \times LF}{Eff_b} \times Hr$
DX A/C	$\frac{Cap_c}{IEER_b \times 1,000} \times EFLH_c$	0	0
Electric Resistance heating	0	$\frac{Cap_h}{HSPF_b \times 1,000} \times EFLH_h$	0

Table 3-105 Energy Efficient Energy Consumption Equations

Qualifying Equipment	Efficient Cooling kWh (kWh _{c,q})	Efficient Heating kWh (kWh _{h,q})	Efficient Circulating Pump kWh (kWh _{p,q})
Water to air water loop heat pumps, water to air ground water heat pumps, brine to air ground loop heat pumps, brine to water ground loop heat pumps	$\frac{Cap_c}{EER_q \times 1,000} \times EFLH_c$	$\frac{Cap_h}{COP_q \times 3.412 \times 1,000} \times EFLH_h$	$\frac{0.746 \times HP_q \times LF \times ESF_{VFD}}{Eff_{motor,q}} \times Hr$
GSHP (Cooling Capacity < 65 kBtu/h)	$\frac{Cap_c}{GSER \times EER_q \times 1,000} \times EFLH_c$	$\frac{Cap_h}{COP_q \times 3.412 \times 1,000} \times EFLH_h$	$\frac{0.746 \times HP_q \times LF \times ESF_{VFD}}{Eff_{motor,q}} \times Hr$
GSHP (Cooling Capacity > 65 kBtu/h)	$\frac{Cap_c}{EER_q \times 1,000} \times EFLH_c$	$\frac{Cap_h}{COP_q \times 3.412 \times 1,000} \times EFLH_h$	$\frac{0.746 \times HP_q \times LF \times ESF_{VFD}}{Eff_{motor,q}} \times Hr$

Annual Fuel Savings

$$\Delta Therms = Therms_b - Therms_q$$

Where,

Therms_b = see Table 3-106 for appropriate baseline equipment type

$$Therms_q = 0$$

Table 3-106 Baseline Fuel Consumption

Baseline Equipment	Baseline fuel consumption (Therms _b)
ASHP, WSHP, GSHP	0
Gas Fired Furnace/Boiler	$\frac{Cap_h}{Eff_{b,fuel} \times 100,000} \times EFLH_h$
Electric resistance heating	0

Peak Demand Savings

$$\Delta kW_{Peak} = kW_{peak,cool} + kW_{peak,pump}$$

Where,

$$\Delta kW_{peak,cool} = Cap_c \times \frac{1}{1,000} \times \left(\frac{1}{EER_b} - \frac{1}{EER_q} \right) \times CF_c$$

$$\Delta kW_{peak,pump} = 0.746 \times \left\{ \left(HP_b \times LF \times \frac{1}{Eff_b} \right) - \left(HP_q \times LF \times \frac{1}{Eff_q} \times DSF_{VFD} \right) \right\} \times CF_{pump}$$

Daily Peak Fuel Savings

$$\Delta Therms_{Peak} = \Delta Therms \times PDF$$

Lifetime Energy Savings Algorithms

Lifetime Electric Energy Savings

No dual baseline:

$$\Delta kWh_{Life} = \Delta kWh \times EUL$$

Dual baseline:

$$\Delta kWh_{Life} = \Delta kWh_{Ex} \times RUL + \Delta kWh_{NR} \times (EUL - RUL)$$

Where,

ΔkWh_{Ex} = annual energy savings calculated as above, using actual existing equipment baseline

ΔkWh_{NR} = annual energy savings calculated as above, using code baseline

Lifetime Fuel Savings

No dual baseline:

$$\Delta Therms_{Life} = \Delta Therms \times EUL$$

Dual baseline:

$$\Delta Therms_{Life} = \Delta Therms_{Ex} \times RUL + \Delta Therms_{NR} \times (EUL - RUL)$$

Where,

$\Delta Therms_{Ex}$ = annual fuel savings calculated as above, using actual existing equipment baseline

$\Delta Therms_{NR}$ = annual fuel savings calculated as above, using code baseline

Calculation Parameters

Table 3-107 Calculation Parameters

Variable	Description	Value	Units	Ref
ΔkWh	Annual electric energy savings	Calculated	kWh/yr	
$\Delta Therms$	Annual fuel savings	Calculated	Therms/yr	
ΔkW_{Peak}	Peak Demand Savings	Calculated	kW	
$\Delta Therms_{Peak}$	Daily peak fuel savings	Calculated	Therms/day	

Variable	Description	Value	Units	Ref
ΔkWh_{Life}	Lifetime electric energy savings	Calculated	kWh	
$\Delta Therms_{Life}$	Lifetime fuel savings	Calculated	Therms	
kWh_b	Baseline electrical consumption	Calculated	kWh/yr	
kWh_q	Energy efficient electrical consumption	Calculated	kWh/yr	
Cap_c	Cooling capacity of qualifying unit	Site-specific	Btu/hr	
Cap_h	Heating capacity of qualifying unit	Site-specific	Btu/hr	
EER_q	EER of qualifying unit	Site-specific	Btu/W-h	
COP_q	Coefficient of performance of the qualifying unit	Site-specific	N/A	
HP_q	Horsepower of qualifying ground/water loop circulating pump motor	Site-specific	HP	
HP_b	Horsepower of base case ground/water loop circulating pump motor	Site-specific, if unknown use HP_q	HP	
$SEER_b$	SEER of baseline unit	Site-specific, if unknown look up in Appendix E: Code-Compliant Efficiencies	Btu/W-h	[446][447]
$IEER_b$	IEER of baseline unit	Site-specific, if unknown look up in Appendix E: Code-Compliant Efficiencies	Btu/W-h	[446][447]
EER_b	EER of baseline unit	Site-specific, if unknown look up in Appendix E: Code-Compliant Efficiencies	Btu/W-h	[446][447]
$HSPF_b$	Heating seasonal performance factor of the baseline unit	Site-specific, if unknown look up in Appendix E: Code-Compliant Efficiencies. For electric resistance heat, use 3.412	Btu/W-h	[446][447]
$Eff_{motor,b}$	Efficiency of base case ground/water loop circulating pump motor	Site-specific, if unknown look up in Table 3-108	N/A	[448]
$Eff_{motor,q}$	Efficiency of qualifying ground/water loop circulating pump motor	Site-specific, if unknown look up in Table 3-108	N/A	[448]
$Eff_{b,fuel}$	Efficiency of baseline boiler/furnace	Site-specific, if unknown look up in Appendix E: Code-Compliant Efficiencies	N/A	[446][447]
OSF	Oversize derating factor ⁸³	Site-specific, if unknown use 0.8	N/A	

⁸³ Heat pump systems are generally sized to meet the peak heating load and are oversized for cooling. The cooling EFLH assumes a nominal 20% oversizing. This derating factor has been added to account for the oversizing of pumps. A user with a more accurate estimation of the oversizing can use a different factor than the one mentioned above to account for oversizing.

Variable	Description	Value	Units	Ref
kWh _{c,b}	Baseline cooling electrical consumption	Look up in Table 3-104	kWh/yr	
kWh _{h,b}	Baseline heating electrical consumption	Look up in Table 3-104	kWh/yr	
kWh _{p,b}	Baseline pump electrical consumption	Look up in Table 3-104	kWh/yr	
kWh _{c,q}	Energy efficient cooling electrical consumption	Look up in Table 3-105	kWh/yr	
kWh _{h,q}	Energy efficient heating electrical consumption	Look up in Table 3-105	kWh/yr	
kWh _{p,q}	Energy efficient pump electrical consumption	Look up in Table 3-105	kWh/yr	
Therms _b	Baseline fuel consumption	Look up in Table 3-106	Therms/yr	
Therms _q	Energy efficient fuel consumption	0	Therms/yr	
EFLH _c	Equivalent Full Load Hours of operation for the average unit during the cooling season	See Appendix C:	Hours	[440]
EFLH _h	Equivalent Full Load Hours of operation for the average unit during the heating season	See Appendix C:	Hours	[440]
COP _b	Coefficient of performance of the baseline unit	Look up in Appendix E: Code-Compliant Efficiencies	N/A	[446][447]
GSER	Factor used to determine the seasonal efficiency of a GSHP based on its EER	1.02	N/A	[441]
1,000	Conversion from hp to Kw	1,000	w/kW	
3.412	Conversion factor from kWh to kBtu	3.412	kBtu/kWh	
0.746	Conversion from HP to kW	0.746	kW/hp	
LF	Load factor of pump motor	0.75	N/A	[442]
ESF _{VFD}	Energy savings factor to account for variable speed pumping in qualifying unit	If variable speed pump: 0.661 If constant speed: 1.0		
DSF _{VFD}	Demand savings factor to account for variable speed pumping in qualifying unit	If variable speed pump: 0.210 If constant speed: 1.0		
Hrs	Operating hours of pump motor, equal to the sum of EFLH _c and EFLH _h	Look up in X	Hours	
CF _c	Cooling coincidence factor	Look up in Table 3-109	N/A	
CF _{pump}	Pump coincidence factor	Look up in Table 3-109	N/A	
PDF	Gas peak day factor	Look up in Table 3-109	N/A	
EUL	Effective useful life	See Measure Life Section	Years	

Table 3-108 Federal Baseline Motor Efficiencies

Motor HP	Motor Nominal Full-Load Efficiencies (percent)							
	2 Poles		4 poles		6 Poles		8 Poles	
	Enclosed	Open	Enclosed	Open	Enclosed	Open	Enclosed	Open
1	77.0	77.0	85.5	85.5	82.5	82.5	75.5	75.5
1.5	84.0	84.0	86.5	86.5	87.5	86.5	78.5	77.0
2	85.5	85.5	86.5	86.5	88.5	87.5	84.0	86.5
3	86.5	85.5	89.5	89.5	89.5	88.5	85.5	87.5
5	88.5	86.5	89.5	89.5	89.5	89.5	86.5	88.5
7.5	89.5	88.5	91.7	91.0	91.0	90.2	86.5	89.5
10	90.2	89.5	91.7	91.7	91.0	91.7	89.5	90.2
15	91.0	90.2	92.4	93.0	91.7	91.7	89.5	90.2
20	91.0	91.0	93.0	93.0	91.7	92.4	90.2	91.0

Peak Factors

Table 3-109 Peak Factors

Peak Factor	Value	Ref
Cooling coincidence factor (CF_c)	0.5	[443]
Pump coincidence factor (CF_{pump})	If unit runs 24/7/365, CF=1.0, else use 0.5	[443]
Natural gas peak day factor (PDF)	TBD	

Measure Life

The remaining useful life (RUL) for existing equipment is limited to 1/3 of the effective useful life (EUL) of the equipment.

Table 3-110 Measure Life

Equipment	EUL	RUL	Ref
Water source Pump	15	5	[445]
Ground source heat pump	25	8.33	[449]

References

- [440] Simulations of prototype buildings from NY TRM updated with NJ weather done by NJ Statewide Evaluator, May 2022
- [441] VEIC estimate. Extrapolation of manufacturer data.
- [442] *Determining Electric Motor Load and Efficiency*. (DOE, 2014), pg 1, <https://www.energy.gov/sites/prod/files/2014/04/f15/10097517.pdf>
- [443] C&I Unitary HVAC Load Shape Project Final Report. August 2011, v.1.1, p. 12, Table O-5. The CF reported here is a center point for NJ chosen between the CF for urban NY and for the Mid-Atlantic region in the PJM peak periods.
- [444] Available at: http://www.neep.org/sites/default/files/resources/NEEP_HVAC_Load_Shape_Report_Final_August2_0.pdf
- [445] California Public Utilities Commission Database for Energy Efficient Resources (DEER) EUL Support Table for 2020, <http://www.deeresources.com/files/DEER2020/download/SupportTable-EUL2020.xlsx>
- [446] ASHRAE Standard 90.1-2019, Energy Standard for Buildings Except Low-Rise Residential Buildings. (ASHRAE, 2019), Table 6.8.1-5, <https://www.ashrae.org/technical-resources/standards-and-guidelines/read-only-versions-of-ashrae-standards>
- [447] ASHRAE Standard 90.1-2013, Energy Standard for Buildings Except Low-Rise Residential Buildings. (ASHRAE, 2019), Table 6.8.1-5, <https://www.ashrae.org/technical-resources/standards-and-guidelines/read-only-versions-of-ashrae-standards>
- [448] § CFR431.25 *Energy conservation standards and effective dates*, (2023) Table 1, <https://www.ecfr.gov/current/title-10/chapter-II/subchapter-D/part-431/subpart-B/subject-group-ECFR03b7039d87b7cc6/section-431.25>
- [449] ASHRAE: Owning and Operating Cost Database, Equipment Life/Maintenance Cost Survey: https://xp20.ashrae.org/publicdatabase/system_service_life.asp?selected_system_type=1

3.5.3 INFRARED HEATER

Market	Commercial/Multifamily
Baseline Condition	NC/TOS/DI
Baseline	Code/Dual
End Use Subcategory	Gas Space Heating Equipment
Measure Last Reviewed	November 2022

Description

This measure outlines the savings for the installation of a gas-fired, low intensity infrared (IR) heating system in place of a unit heater, furnace, or other standard efficiency equipment in commercial and industrial facilities.

Savings are based on the reduced input capacity requirement with the radiant heating of an IR Heater (efficient) as opposed to convective heating of a conventional heating system (baseline). The thermal efficiency is assumed to be equivalent between the baseline and efficient case.

The algorithms do not include potential savings as a result of a few baseline assumptions. For example, if the baseline is assumed to be a furnace, there will be kwh savings associated with reduction in fan energy reduction.

Baseline Case

Code-compliant furnace, unit heater, or other standard efficiency equipment. For new construction, a gas-fired warm unit heater shall be assumed.

Efficient Case

The efficient case condition is a low-intensity, gas-fired infrared heater. The prescribed methodology assumes a reduction of 10°F to maintain occupant comfort. [452]

Annual Energy Savings Algorithm

Annual Electric Energy Savings

$$\Delta kWh = N/A$$

Annual Fuel Savings

$$\Delta Therms = Cap_{in} * \left(1 - \frac{HDD_{55}/(55 - T_{design})}{HDD_{65}/(65 - T_{design})} \right) * \frac{EFLH_h}{100}$$

Peak Demand Savings

$$\Delta kW_{Peak} = N/A$$

Daily Peak Fuel Savings

$$\Delta Therms_{Peak} = \Delta Therms \times PDF$$

Lifetime Energy Savings Algorithms

Lifetime Electric Energy Savings

$$\Delta kWh_{Life} = N/A$$

Lifetime Fuel Savings

$$\Delta Therms_{Life} = \Delta Therms \times EUL$$

Dual:

Lifetime Electric Energy Savings

$$\Delta kWh_{Life} = N/A$$

Lifetime Fuel Savings

$$\Delta Therms_{Life} = \Delta Therms_{EREP} \times RUL + \Delta Therms_{NR} \times EUL$$

Calculation Parameters

Table 3-111 Calculation Parameters

Variable	Description	Value	Units	Ref
$\Delta Therms$	Annual fuel savings	Calculated	Therms/yr	
$\Delta Therms_{Peak}$	Daily peak fuel savings	Calculated	Therms/day	
$\Delta Therms_{Life}$	Lifetime fuel savings	Calculated	Therms	
Cap_{in}	Input capacity of qualifying unit	Site-specific	kBtu/hr	
HDD_{55}	Heating degree days: number of degrees the average daily temperature is below 55°F	Look up in Table 3-112	°F-day	
HDD_{65}	Heating degree days: number of degrees the average daily temperature is below 65°F	Look up in Table 3-112	°F-day	[450]
T_{design}	Equipment design temperature	Look up in Table 3-112	°F	[453]
$EFLH_h$	Equivalent Full Load Hours of operation for the average unit during the heating season		hour/yr	[451]
100	Conversion from kBtu to therms	100	kBtu/therms	
EUL	Effective useful life	See Measure Life Section	Years	
RUL	Remaining useful life of existing unit	See Measure Life Section	Years	

Table 3-112 Heating Degree Days and Equipment Design Temperature

Climate Zone	HDD ₆₅	HDD ₅₅	T _{design}
Northern	6,136	3,759	8.1
Central	5,588	3,331	11.6
Pine Barrens	5,529	3,294	10.5
Southwest	5,658	3,418	13.8
Coastal	4,795	2,573	11.6

Peak Factors**Table 3-113 Peak Factors**

Peak Factor	Value	Ref
Electric coincidence factor (CF)	N/A	
Natural gas peak day factor (PDF)	See Appendix G: Natural Gas Peak Day Factors	

Measure Life**Table 3-114 Measure Life**

Equipment	EUL	RUL	Ref
Infrared Heater	17	5.7	[455]

References

- [450] TMY3 data for NJ climate zone representative cities: Northern – Allentown, PA; Central – Trenton, NJ; Pine Barrens – McGuire AFB NJ; Southwest – Philadelphia, PA International Airport; Coastal – Atlantic City, NJ.
- [451] Simulations of prototype buildings from NY TRM updated with NJ weather done by NJ Statewide Evaluator, May 2022
- [452] 2012 ASHRAE Handbook – HVAC Systems and Equipment, Chapter 16, Infrared Radiant Heating.
- [453] ASHRAE Fundamentals 2021, Chapter 14 Climactic Design
Conditions, <https://handbook.ashrae.org/Handbook.aspx#>. Based on NJ climate zone representative cities: Northern – Allentown, PA; Central – Trenton, NJ; Pine Barrens – McGuire AFB NJ; Southwest – Philadelphia, PA International Airport; Coastal – Atlantic City, NJ.
- [454] GDS Associates, Inc. “Natural Gas Efficiency Potential Study.” DTE Energy. July 29, 2016. Available from: https://www.michigan.gov/documents/mpsc/DTE_2016_NG_ee_potential_study_w_appendices_vFINAL_554360_7.pdf

[455] California Public Utilities Commission EUL Table, version 027 (updated November 12, 2022). Accessed December 30, 2022. <https://www.caetrm.com/shared-data/value-table/EUL/>

3.5.4 FURNACES, UNIT HEATERS AND BOILERS

Market	Commercial/Multifamily
Baseline Condition	NC/NR/DI/EREP
Baseline	Code/ISP/Dual
End Use Subcategory	Gas Space Heating Equipment
Measure Last Reviewed	November 2022

Description

This measure encourages the installation of high-efficiency, natural gas-fired furnaces, unit heaters and closed loop space heating boilers meeting program eligibility requirements. Equipment sizing assumes compliance with ASHRAE 90.1 - 2019 sizing requirements.

Baseline Case

For NC and NR programs, the baseline unit is a code compliant unit with efficiency as required by ASHRAE Std. 90.1 – 2019 and IECC 2021, which are the current codes adopted by the State of New Jersey. For New Construction, an Industry Standard Practice baseline which is 15% more efficient than Code applies to furnaces.

For early replacement projects, use dual baselines:

- For the remaining useful life of the existing equipment, the baseline is the actual existing equipment. If the site specific efficiency of the existing equipment is unknown, use the ASHRAE 90.1-2013 efficiency for the existing equipment type (see Appendix E: Code-Compliant Efficiencies).
- For the duration of the measure life, the baseline is a code-compliant air source heat pump.

Efficient Case

Equipment with an efficiency higher than Code or ISP that meets program eligibility requirements. No size limits on furnaces or unit heaters.

Annual Energy Savings Algorithms

Annual Electric Energy Savings

$$\Delta kWh = kWh_b - kWh_q$$

Where,

$$kWh_b = \frac{Cap_h}{HSPF_b \times 1,000} \times EFLH_h \text{ (Electric Resistance Baseline)}$$

$$kWh_b = 0 \text{ (Gas Equipment Baseline)}$$

$$kWh_q = 0$$

Annual Fuel Savings

$$\Delta Therms = Therms_b - Therms_q$$

Where,

$$Therms_b = \frac{Cap_h}{Eff_{AF} \times Eff_b \times 100,000} \times EFLH_h \text{ (Gas Equipment Baseline)}$$

$$Therms_b = 0 \text{ (Electric Baseline)}$$

$$Therms_q = \frac{Cap_h}{Eff_q \times 100,000} \times EFLH_h$$

Peak Demand Savings

$$\Delta kW_{Peak} = N/A$$

Daily Peak Fuel Savings

$$\Delta Therms_{Peak} = \Delta Therms \times PDF$$

Lifetime Energy Savings Algorithms

Lifetime Electric Energy Savings

No dual baseline:

$$\Delta kWh_{Life} = \Delta kWh \times EUL$$

Dual baseline:

$$\Delta kWh_{Life} = (\Delta kWh \text{ using existing baseline}) \times RUL + (\Delta kWh \text{ using code baseline}) \times (EUL - RUL)$$

Lifetime Fuel Savings

No dual baseline:

$$\Delta Therms_{Life} = \Delta Therms \times EUL$$

Dual baseline:

$$\Delta Therms_{Life} = (\Delta Therms \text{ using existing baseline}) \times RUL + (\Delta Therms \text{ using code baseline}) \times (EUL - RUL)$$

Calculation Parameters

Table 3-115 Calculation Parameters

Variable	Description	Value	Units	Ref
ΔkWh	Annual electric energy savings	Calculated	kWh/yr	
$\Delta Therms$	Annual fuel savings	Calculated	Therms/yr	
$\Delta Therms_{Peak}$	Daily peak fuel savings	Calculated	Therms/day	
ΔkWh_{Life}	Lifetime electric energy savings	Calculated	kWh	
$\Delta Therms_{Lifetime}$	Lifetime fuel savings	Calculated	Therms	
Cap_{in}	Input capacity of qualifying unit	Site-specific	Btu/hr	
Eff_q	Equipment Proposed Efficiency	Site-specific	Varies	
$HSPF_b$	Heating seasonal performance factor of baseline electric unit	Site-specific or look up in Appendix E: Code-Compliant Efficiencies		
$EFLH_h$	Equivalent Full Load Hours of operation for the average unit during the heating season	Look up in Appendix C: Heating and Cooling EFLH	Hrs/yr	[456]
Eff_b	Gas equipment baseline efficiency	Look up in Table 3-116	Varies	[457][458]
Eff_{AF}	Equipment baseline efficiency ISP adjustment Factor	1.15 (New Construction furnaces only) 1.0 (all others)	N/A	[459]
1,000	Conversion factor	1,000	Watts/kW	
100,000	Conversion factor	100,000	Btu/Therm	
CF	Electric coincidence factor	Look up in Table 3-117 Peak Factors	N/A	
PDF	Gas peak day factor	Look up in Table 3-117 Peak Factors	N/A	
EUL	Effective useful life	See Measure Life Section	Years	
RUL	Remaining useful life of existing unit	See Measure Life Section	Years	

Table 3-116 Baseline Efficiencies

Equipment	Type	Size Category (kBtu input)	ASHRAE Standard 90.1-2019 Efficiency
Furnace	Gas Fired	< 225	Nonweatherized 80% AFUE Weatherized 81% AFUE or 80% Et
	Gas Fired	\geq 225	81% Et
	Oil Fired	< 225	Nonweatherized excluding mobile home 83% AFUE Nonweatherized mobile home 75% AFUE

Equipment	Type	Size Category (kBtu input)	ASHRAE Standard 90.1-2019 Efficiency
			Weatherized 78% AFUE
	Oil Fired	≥ 225	82% Et
Unit Heater	Gas Fired, Oil Fired	All Capacities	80% Ec
Hot Water Boiler	Gas Fired	<300	82% AFUE
		≥300 and ≤ 2,500	80% Et
		>2,500	82% Ec
	Oil Fired	<300	84% AFUE
		≥300 and ≤ 2,500	82% Et
		>2,500	84% Ec
Steam Boiler	Gas Fired	<300	82% AFUE
	Gas Fired All Except Natural Draft	≥300 and ≤ 2,500	79% Et
		>2,500	79% Et
	Gas Fired Natural Draft	≥300 and ≤ 2,500	79% Et
		>2,500	79% Et
	Oil Fired	<300	85% AFUE
		≥300 and ≤ 2,500	81% Et
		>2,500	81% Et

Peak Factors

Table 3-117 Peak Factors

Peak Factor	Value	Ref
Electric coincidence factor (CF)	N/A	
Natural gas peak day factor (PDF)	See Appendix G: Natural Gas Peak Day Factors	

Measure Life

The remaining useful life (RUL) for existing equipment is limited to 1/3 of the effective useful life (EUL) of the equipment.

Table 3-118 Measure Life

Equipment	EUL	RUL	Ref
Furnace	20	6.67	[460]
Unit Heater	18	6	[461]

Equipment	EUL	RUL	Ref
Boiler	20	6.67	[460]
Electric Resistance Heating	20	6.67	[462]

References

- [456] Simulations of prototypical buildings from the NY TRM updated with NJ weather done by NJ Statewide Evaluator, May 2022
- [457] *ASHRAE Standard 90.1-2019, Energy Standard for Buildings Except Low-Rise Residential Buildings.* (ASHRAE, 2019), Table 6.8.1-5, <https://www.ashrae.org/technical-resources/standards-and-guidelines/read-only-versions-of-ashrae-standards>
- [458] *2021 INTERNATIONAL ENERGY CONSERVATION CODE (IECC) | ICC DIGITAL CODES* (IECC 2021), Table C403.3.2(5) <https://codes.iccsafe.org/content/IECC2021P2/chapter-4-ce-commercial-energy-efficiency>
- [459] *New Jersey Commercial New Construction Industry Standard Practice Analysis.* Prepared for Rutgers University by DNV. June 2022.
- [460] California Database of Energy Efficient Resources (DEER)
http://www.deeresources.com/files/DEER2013codeUpdate/download/DEER2014-EUL-table-update_2014-02-05.xlsx
- [461] Ecotope, *Natural Gas Efficiency and Conservation Measure Resource Assessment*, 2003, section 5.2.3, https://ecotope-publications-database.ecotope.com/2003_007_NaturalGasEfficiency.pdf
- [462] *Energy Saver 101: Everything you need to know about Home Heating*
<https://www.energy.gov/sites/prod/files/2014/01/f6/homeHeating.pdf>

3.5.5 BOILER CONTROLS

Market	Commercial/Multifamily
Baseline Condition	RF
Baseline	Existing
End Use Subcategory	Control
Measure Last Reviewed	November 2022

Description

Boiler reset controls automatically adjust the boiler water temperature based on the outdoor air temperature. Boiler cut-out controls use sensors to determine when outside air has reached a specific temperature and turn off the boiler and its connected heating system. Optionally, a timer to control when heating equipment comes on and when it goes off may also be included. These controls are most often installed together using controls that accomplish both functions.

This measure is limited to cut-out controls on non-condensing boilers since boiler reset savings is minimal for non-condensing boilers. Both boiler reset and cut-out controls are applicable to condensing boilers.

Baseline Case

Existing boiler without controls.

Efficient Case

Installation of boiler reset and/or cut-out controls. The system's minimum temperature setpoint must be set no more than 10 degrees above manufacturer's recommended minimum return temperature.

Annual Energy Savings Algorithm

Annual Electric Energy Savings

$$\Delta kWh = N/A$$

Annual Fuel Savings

$$\Delta Therms = SF \times \frac{EFLH_h \times Cap_{in}}{100}$$

Peak Demand Savings

$$\Delta kW_{Peak} = N/A$$

Daily Peak Fuel Savings

$$\Delta Therms_{Peak} = N/A$$

Lifetime Energy Savings Algorithms:

Lifetime Electric Energy Savings

$$\Delta kWh_{Life} = N/A$$

Lifetime Fuel Savings

$$\Delta Therms_{Life} = \Delta Therms \times EUL$$

Calculation Parameters

Table 3-119 Calculation Parameters

Variable	Description	Value	Units	Ref
$\Delta Therms$	Annual fuel savings	Calculated	Therms/yr	
$\Delta Therms_{Peak}$	Daily peak fuel savings	Calculated	Therms/day	
$\Delta Therms_{Life}$	Lifetime fuel savings	Calculated	Therms	
SF	Savings Factor: estimated percent reduction in heating load due to controls being installed.	Lookup in Table 3-120	%	[463] [464]
EFLH _h	Equivalent full load hours for heating	Look up in Appendix C:	hrs	[465]
Cap _{in}	Input capacity of boiler	Site-specific	kBtu/hr	
EUL	Effective useful life	See Measure Life Section	yrs	
100	Conversion from kBtu to therm	100	kBtu	

Table 3-120 Savings Percentage

Control Type	Savings	Ref
Boiler Reset	5.0%	[463]
Boiler Cut-Out	2.2%	[464]
Boiler Reset & Cut-Out	5%	

Peak Factors

Table 3-121 Peak Factors

Peak Factor	Value	Ref
Coincidence Factor (CF)	N/A	
Natural gas peak day factor (PDF)	Appendix G: Natural Gas Peak Day Factors	

Measure Life

The effective useful life (EUL) of boiler controls is limited to the smaller of the measure life or the remaining useful life (RUL) of the boiler. If boiler RUL unknown, assume 1/3 of the boiler EUL.

Table 3-122 Measure Life

Equipment	EUL	RUL	Ref
Boiler Controls	Smaller of: boiler RUL or 7.33	N/A	
Boiler (steel water-tube)	22	7.33	[466]
Boiler (steel fire-tube)	25	8.33	[466]
Boiler (cast iron)	35	11.67	[466]

References

- [463] GDS Associates, Inc. Natural Gas Energy Efficiency Potential in Massachusetts, 2009, p. 38 Table 6-4. https://ma-eeac.org/wp-content/uploads/5_Natural-Gas-EE-Potential-in-MA.pdf
- [464] Arkansas Technical Reference Manual, Version 7, Volume 2, page 234 and 229. The savings factors for Reset (3.8%) and Cut-Out (1.7%) were used to scale the Cut-Out savings factor proportionally to 2.2%.
- [465] Simulations of prototypical buildings from the NY TRM updated with NJ weather done by NJ Statewide Evaluator, May 2022.
- [466] ASHRAE Handbook 2019, HVAC Applications. Chapter 38 *Owning and Operating Costs*, Table 4.

3.5.6 BOILER ECONOMIZER

Market	Commercial/Multifamily
Baseline Condition	NC/RF
Baseline	Existing
End Use Subcategory	Control
Measure Last Reviewed	November 2022

Description

This measure covers the installation of a boiler economizer, also known as stack economizers and feedwater economizers. Boiler economizers are designed to recover heat from hot flue gases which is then used to pre-heat boiler feedwater thereby reducing heating requirements. Condensing and conventional non-condensing economizers are the two principal types of boiler economizers.

Non-condensing or conventional economizers are typically air-to-water heat exchangers and operate above the flue gas dew point to avoid condensation [467].

Condensing economizers allow condensing of the exhaust gas components and reduce the flue gas temperature below its dew point. This results in latent heat being recaptured, thereby improving the effectiveness of waste heat recovery [469].

This measure is applicable to the installation of condensing and non-condensing economizers on boilers serving space heating loads and process loads and is restricted to non-condensing, forced draft burner boilers.

Baseline Case

The baseline condition is a non-condensing, forced draft burner boiler serving space heating or process loads without a boiler economizer.

Efficient Case

The compliance condition is a non-condensing, forced draft burner boiler serving space heating or process loads with a non-condensing or condensing boiler economizer.

Annual Energy Savings Algorithms

Annual Electric Energy Savings

$$\Delta kWh = N/A$$

Annual Fuel Savings

Economizer for Boilers Serving HVAC Loads:

$$\Delta Therms = Cap_{in} \times \frac{ESF \times EFLH_h}{100}$$

Where,

$$ESF = \frac{T_b - T_q}{40} \times TRE$$

Economizer for Boilers Serving Process Loads:

$$\Delta Therms = Cap_{in} \times \frac{ESF \times 8,766 \times UF}{100}$$

Where,

$$ESF = \frac{T_b - T_q}{40} \times TRE$$

Peak Demand Savings

$$\Delta kW_{Peak} = N/A$$

Daily Peak Fuel Savings

$$\Delta Therms_{Peak} = \Delta Therms \times PDF$$

Lifetime Energy Savings Algorithms

Lifetime Electric Energy Savings

$$\Delta kWh_{Life} = N/A$$

Lifetime Fuel Savings

$$\Delta Therms_{Life} = \Delta Therms \times EUL$$

Calculation Parameters

Table 3-123 Calculation Parameters

Variable	Description	Value	Units	Ref
$\Delta Therms$	Annual fuel savings	Calculated	Therms/yr	
$\Delta Therms_{Peak}$	Daily peak fuel savings	Calculated	Therms/day	
$\Delta Therms_{Life}$	Lifetime fuel savings	Calculated	Therms	

Variable	Description	Value	Units	Ref
ESF	Energy Savings Factor	Calculated	N/A	[470]
Cap _{in}	Input capacity of qualifying unit	Site-specific	kBtu/hr	
T _b	Baseline full-fire boiler flue gas temperature as it exits the stack	Site-specific. If unknown, use the default of 420°F for hot water boilers and 500°F for steam boilers ⁸⁴	°F	[471]
T _q	Energy efficient full-fire boiler flue gas temperature as it exits the stack	Site-specific. If unknown, look up in Table 3-124	°F	[468]
TRE	Temperature Reduction Efficiency; percentage efficiency increases for stack temperature reduction, per 40°F reduction in net stack temperature	Site-specific. If unknown, use a default of 0.01	N/A	[470]
EFLH _h	Equivalent Full Load Hours of operation for the average unit during the heating season	Look up in Appendix C:	Hrs/yr	[471]
100	Conversion from kBtu to therms	100	kBtu/Therms	
40	Stepped reduction in net stack temperature, in °F	40	°F	
8,766	Process load boiler operating hours	8,766	Hrs/yr	[474]
UF	Utilization factor	0.419	N/A	[474]
PDF	Gas peak day savings factor	Look up in Table 3-125	N/A	
EUL	Effective useful life	See Measure Life Section	Years	

Table 3-124 Energy Efficient Boiler Flue Gas Temperature

Equipment Type	Conventional Economizer ^{85,86}	Condensing Economizer ^{87,88}
Hot Water Boiler	335 °F	247.5 °F
Steam Boiler	375 °F	287.5 °F

⁸⁴ Assumes hot water boiler efficiency of 82% and steam boiler efficiency of 80%

⁸⁵ As cited in U.S. DOE, Steam Tip Sheet #26A, Consider Installing a Condensing Economizer, the minimum stack temperature for a non-condensing economizer is 250°F. The average temperature drop is assumed to be halfway between the baseline and efficient temperature minimum: $(420^{\circ}\text{F} + 250^{\circ}\text{F}) / 2 = 335^{\circ}\text{F}$

⁸⁶ Ibid, the minimum stack temperature for a non-condensing economizer is 250°F: $(500^{\circ}\text{F} + 250^{\circ}\text{F}) / 2 = 375^{\circ}\text{F}$

⁸⁷ Ibid, the minimum stack temperature for a condensing economizer is 75°F: $(420^{\circ}\text{F} + 75^{\circ}\text{F}) / 2 = 247.5^{\circ}\text{F}$

⁸⁸ Ibid, the minimum stack temperature for a condensing economizer is 75°F: $(500^{\circ}\text{F} + 75^{\circ}\text{F}) / 2 = 287.5^{\circ}\text{F}$

Peak Factors

Table 3-125 Peak Factors

Peak Factor	Value	Ref
Electric coincidence factor (CF)	N/A	
Natural gas peak day factor (PDF)	See Appendix G: Natural Gas Peak Day Factors	

Measure Life

The effective useful life (EUL) of the boiler economizer is limited to the remaining useful life (RUL) of the boiler. If unknown, assume 1/3 of the boiler EUL.

Table 3-126 Measure Life

Equipment	EUL	RUL	Ref
Boiler	20	6.67	[466]

References

- [467] US DOE, "Improving Steam System Performance: A Sourcebook for Industry, Second Edition", 2004.
<https://www.energy.gov/sites/prod/files/2014/05/f15/steamsourcebook.pdf>
- [468] US DOE, "ADVANCED MANUFACTURING OFFICE Energy Tips: STEAM Steam Tip Sheet #26A." n.d.
https://www.energy.gov/sites/prod/files/2014/05/f16/steam26a_condensing.pdf
- [469] US DOE, "ADVANCED MANUFACTURING OFFICE Energy Tips: STEAM Steam Tip Sheet #26B." n.d.
https://www.energy.gov/sites/prod/files/2014/05/f16/steam26b_condensing.pdf
- [470] US DOE, "ADVANCED MANUFACTURING PROGRAM Energy Tips: STEAM Steam Tip Sheet #3 Use Feedwater Economizers for Waste Heat Recovery." n.d.
https://www.energy.gov/sites/prod/files/2014/05/f16/steam3_recovery.pdf
- [471] ECCCNYS 2020 Table C403.3.2(5): Minimum Efficiency Requirements: Gas- And Oil-Fired Boilers & Table C404.2: Minimum Performance of Water Heating Equipment.
<https://codes.iccsafe.org/content/NYSECC2020P1/chapter-4-ce-commercial-energy-efficiency>
- [472] Simulations of prototype buildings from NY TRM updated with NJ weather done by NJ Statewide Evaluator, May 2022
- [473] California Database of Energy Efficient Resources (DEER).
http://www.deeresources.com/files/DEER2013codeUpdate/download/DEER2014-EUL-table-update_2014-02-05.xlsx
- [474] 2022 Illinois Statewide Technical Reference Manual for Energy Efficiency Version 10.0: Volume 2 (2022), Pg 357. https://www.ilsag.info/wp-content/uploads/IL-TRM_Effective_010122_v10.0_Vol_2_C_and_I_09242021.pdf

3.5.7 GAS CHILLERS

Market	Commercial
Baseline Condition	TOS/NC
Baseline	Code
End Use Subcategory	Equipment
Measure Last Reviewed	January 2023

Description

This measure describes the energy savings resulting from installing a gas-fueled absorption chiller more efficient than code. The calculation of energy savings for C&I gas fired chillers and in time of sale and new construction applications is based on algorithms with key variables captured on the application form or from manufacturer's data sheets.

Note that this measure applies to only absorption chillers, in keeping with ASHRAE 90.1-2019 efficiency specifications. For other types of gas chillers, or complex cooling systems, consider using a custom analysis approach.

Baseline Case

Minimally code-compliant gas-fueled absorption chiller with a baseline efficiency as defined in ASHRAE 90.1-2019.

Efficient Case

A new efficient gas-fueled absorption chiller, more efficient than code.

Annual Energy Savings Algorithms

Annual Electric Energy Savings

$$\Delta kWh = N/A$$

Annual Fuel Savings

$$\Delta Therms = Cap \times \left(\frac{1}{COP_b} - \frac{1}{COP_q} \right) \times EFLH_c \times 10$$

Peak Demand Savings

$$\Delta kW_{Peak} = N/A$$

Daily Peak Fuel Savings

$$\Delta Therms_{Peak} = \Delta Therms \times PDF$$

Lifetime Energy Savings Algorithms

Lifetime Electric Energy Savings

$$\Delta kWh_{Life} = N/A$$

Lifetime Fuel Savings

$$\Delta Therms_{Life} = \Delta Therms \times EUL$$

Calculation Parameters

Table 3-127 Calculation Parameters

Variable	Description	Value	Units	Ref
$\Delta Therms$	Annual fuel savings	Calculated	Therms/yr	
$\Delta Therms_{Winter}$	Annual winter fuel savings	Calculated	Therms/yr	
$Therms_{Summer}$	Annual summer fuel usage	Calculated	Therms/yr	
$\Delta Therms_{Peak}$	Daily peak fuel savings	Calculated	Therms/day	
$\Delta Therms_{Life}$	Lifetime fuel savings	Calculated	Therms	
Cap	The rated capacity of the energy efficient chiller at site design conditions accepted by the program	Site-specific	tons	
IR	Input rating	Site-specific	MMBtu/hr	
Cap	Cooling capacity of gas chiller	Site-specific	MMBtu/hr	
COP_b	Coefficient of performance of baseline unit	Site-specific, if unknown look up in Table 3-128	N/A	
COP_q	Coefficient of performance of energy efficient unit	Site-specific	N/A	
$EFLH_h$	Equivalent full load hours, heating	Look up in Appendix C:		
CF	Electric coincidence factor	Look up in Table 3-129	N/A	
PDF	Gas peak day factor	Look up in Table 3-129	N/A	
10	Unit conversion, Therms/MMBtu	10	Therms/MMBtu	
EUL	Effective useful life	See Measure Life Section	Years	

Table 3-128 Minimum Gas Chiller Efficiencies, AHRAE 90.1-2019

Equipment	Minimum COP
Air cooled absorption, single effect	0.6 FL
Water cooled absorption, single effect	0.7 FL
Absorption double effect, indirect fired	1.0 FL 1.05 IPLV
Absorption double effect, direct fired	1.0 FL 1.0 IPLV

Peak Factors

Table 3-129 Peak Factors

Peak Factor	Value
Electric coincidence factor (CF)	N/A
Natural gas peak day factor (PDF)	See Appendix G: Natural Gas Peak Day Factors

Measure Life

The effective useful life (EUL) is 20 years [475].

References

[475] DEER 2014

3.5.8 ELECTRIC CHILLERS

Market	Commercial/Multifamily
Baseline Condition	TOS/NC
Baseline	Code
End Use Subcategory	Equipment
Measure Last Reviewed	December 2022

Description

This prescriptive measure targets the use of electric chillers in all commercial facilities.

This measure applies to new construction, replacement of failed equipment, or end of useful life. The baseline chiller is a minimally code-compliant chiller with an efficiency as required by ASHRAE Std. 90.1 – 2019, which is the current code adopted by the state of New Jersey.

Baseline Case

New Construction/Replacement of Failed Equipment/End of Useful Life: Chiller compliant with ASHRAE Std. 90.1–2019.

Efficient Case

Chiller with an efficiency greater than code.

Annual Energy Savings Algorithm

Annual Electric Energy Savings

$$\Delta kWh = Tons \times EFLH_c \times (IPLV_b - IPLV_q)$$

Annual Fuel Savings

$$\Delta Therms = N/A$$

Peak Demand Savings

$$\Delta kW_{Peak} = Tons \times CF \times (FLV_b - FLV_q)$$

Daily Peak Fuel Savings

$$\Delta Therms_{Peak} = N/A$$

Lifetime Energy Savings Algorithms:

Lifetime Electric Energy Savings

$$\Delta kWh_{Life} = \Delta kWh \times EUL$$

Lifetime Fuel Savings

$$\Delta Therms_{Life} = N/A$$

Calculation Parameters

Table 3-130 Calculation Parameters

Variable	Description	Value	Units	Ref
ΔkWh	Annual electric energy savings	Calculated	kWh/yr	
ΔkW_{Peak}	Peak Demand Savings	Calculated	kW	
ΔkWh_{Life}	Lifetime electric energy savings	Calculated	kWh	
Tons/Unit	Rated capacity of cooling equipment.	Site-specific	Tons	
$IPLV_b$	Integrated Part Load Value of baseline equipment, the efficiency of the chiller under partial-load conditions	Site-specific. If unknown, look up in Table 3-131	kW/ton	[477]
$IPLV_q$	Integrated Part Load Value of qualifying unit, the efficiency of the chiller under partial-load conditions	Site-specific	kW/ton	
FLV_b	Full Load Value of baseline equipment, the efficiency of the chiller under full-load conditions	Site-specific. If unknown, look up in Table 3-131	kW/ton	[477]
FLV_q	Full Load Value of baseline equipment, the efficiency of the chiller under full-load conditions	Site-specific	kW/ton	
$EFLH_c$	Equivalent Full Load Cooling Hours	Look up in Appendix F: HVAC Interactivity Factors	hr	[478]
CF	Electric coincidence factor	Table 3-132	N/A	
EUL	Effective useful life	See Measure Life Section	Years	

Table 3-131 Water-Chilling Minimum Efficiency, ASHRAE 90.1–2019 (Table 6.8.1-3)

Equipment Type	Size Category	Path A		Path B	
		FLV (kW/ton)	IPLV (kW/ton)	FLV (kW/ton)	IPLV (kW/ton)
Air Cooled	tons < 150	1.188	0.876	1.237	0.759
	tons > 150	1.188	0.857	1.237	0.745
Water Cooled Positive Displacement (rotary screw and scroll)	tons < 75	0.750	0.600	0.780	0.500
	75 <= tons < 150	0.720	0.560	0.750	0.490
	150 <= tons < 300	0.660	0.540	0.680	0.440
	300 <= tons < 600	0.610	0.520	0.625	0.410
	tons >= 600	0.560	0.500	0.585	0.380
Water Cooled Centrifugal	tons < 150	0.610	0.550	0.695	0.440
	150 < tons < 300	0.610	0.550	0.635	0.400
	300 < tons < 400	0.560	0.520	0.595	0.390
	400 < tons < 600	0.560	0.500	0.585	0.380
	tons > 600	0.560	0.500	0.585	0.380

Notes:

1. Path A is generally used with equipment designed to maximize full load efficiency. Either Path A or Path B may be used to demonstrate compliance.
2. Path B is generally used with equipment designed to maximize part-load efficiency. Either Path A or Path B may be used to demonstrate compliance.
3. Typically, constant speed chillers use Path A values whereas variable speed chillers use Path B values.

Peak Factors

Table 3-132 Peak Factors

Peak Factor	Value	Ref
Electric coincidence factor (CF)	0.67	[476]
Natural gas peak day factor (PDF)	N/A	

Measure Life

The effective useful life (EUL) is 23 years. [479]

References

- [476] New Jersey Board of Public Utilities, *New Jersey’s Clean Energy Program Protocols to Measure Resource Savings: FY2022 Addendum*. (New Jersey Board of Public Utilities, 2022), pg 27.

- [477] ASHRAE Standard 90.1-2019, Energy Standard for Buildings Except Low-Rise Residential Buildings. (ASHRAE, 2019), Table 6.8.1-3. <https://www.ashrae.org/technical-resources/standards-and-guidelines/read-only-versions-of-ashrae-standards>
- [478] Simulations of prototype buildings from NY TRM updated with NJ weather done by NJ Statewide Evaluator, May 2022.
- [479] GDS Associates, Inc. 2007. *Measure Life Report Residential and Commercial/Industrial Lighting and HVAC Measures*. Prepared for the New England State Program Working Group (SPWG).

3.5.9 MAKE-UP AIR UNIT

Market	Commercial/Multifamily
Baseline Condition	TOS/NC/DI
Baseline	Code/Dual
End Use	HVAC
Measure Last Reviewed	December 2022

Description

This section provides energy savings algorithms for make-up air systems in commercial applications. These systems utilize an indirect gas-fired process to heat 100% outside air (OA) to provide ventilation or make-up air to commercial and industrial spaces. The unitary package must contain an indirect gas-fired warm air furnace section.

The annual OA heating load per cfm of OA (Q_{OA}) was determined for each New Jersey location by scaling the heating load derived from the Illinois TRM V9.0 using heating degree days for each location.

The IL TRM Q_{OA} Values were determined based on hourly differences between a range of supply air temperatures (SAT) and outside air temperature (OAT) using TMY3 Data. 3 different base temperatures were used to calculate the heating loads, 45 °F, 55 °F, and 65 °F. The loads are then summed for the entire year.

To determine the appropriate value, follow the guidance below to use Table 3-134 through Table 3-146.

First, select the most representative operating schedule for the application from among the four scenarios listed below. Second, select the representative HDD base temperature. If that base temperature is not readily determined, select the TRM default base temperature of 55 °F (HDD55) for heating in C&I settings. Third, select the climate zone. Fourth, select an appropriate heated to supply air (SA) temperature. Use the resulting Q_{OA} value.

The four scenarios available are indicative of the following building applications and operating schedules:

1. 24-hour-a-day and 7-day-a-week (24/7) operation, with HVAC operating schedule of 8,760 hours per year, typical of large retail stores with DOAS, hotel/multifamily buildings with corridor MUAS, and healthcare facilities with DOAS. Use Table 3-135 through Table 3-137.
2. 6:00 AM to 1:00 AM every day operation, with HVAC operating schedule of 7,300 hours per year, typical of full service and quick service restaurants with kitchen MUAS. Use Table 3-138 through Table 3-140.
3. 7:00 AM to 9:00 PM Monday-Friday, 7:00 AM to 10:00 PM Saturday, and 9:00 AM to 7:00 PM Sunday operations, with HVAC operating schedule of 5,266 hours per year, typical of non-24/7 retail stores with DOAS. Use Table 3-141 through Table 3-143.
4. 7:00 AM to 9:00 PM Monday-Friday operation, with HVAC operating schedule of 3,911 hours per year, typical of school buildings with DOAS. Use Table 3-144 through Table 3-146.

Baseline Case

The baseline case is a make-up air unit that contains a non-condensing gas-fired warm air furnace compliant with ASHRAE Std. 90.1 – 2019 and IECC 2021.

Efficient Case

The efficient case is an efficient make-up air unit that contains a condensing gas-fired warm air furnace with a thermal efficiency higher than code.

Annual Energy Savings Algorithm

Annual Electric Energy Savings

$$\Delta kWh = \frac{t_{fan} \times CFM \times \Delta P}{Eff_{fan,motor} \times 8,520}$$

Annual Fuel Savings

$$\Delta Therms = \frac{Q_{OA} \times CFM \times \left(\frac{1}{Eff_b} - \frac{1}{Eff_q} \right)}{100,000}$$

Peak Demand Savings

$$\Delta kW_{Peak} = \frac{\Delta kWh}{t_{fan}} \times CF$$

Daily Peak Fuel Savings

$$\Delta Therms_{Peak} = \Delta Therms \times PDF$$

Lifetime Energy Savings Algorithms:

Lifetime Electric Energy Savings

$$\Delta kWh_{Life} = \Delta kWh \times EUL$$

Lifetime Fuel Savings

$$\Delta Therms_{Life} = \Delta Therms \times EUL$$

Dual:

Lifetime Electric Energy Savings

$$\Delta kWh_{Life} = \Delta kWh_{EREP} \times RUL + \Delta kWh_{NR} \times EUL$$

Lifetime Fuel Savings

$$\Delta Therms_{Life} = \Delta Therms_{EREP} \times RUL + \Delta Therms_{NR} \times EUL$$

Calculation Parameters

Table 3-133 Calculation Parameters

Variable	Description	Value	Units	Ref
ΔkWh	Annual electric energy savings	Calculated	kWh/yr	
$\Delta Therms$	Annual fuel savings	Calculated	Therms/yr	
ΔkW_{Peak}	Peak Demand Savings	Calculated	kW	
$\Delta Therms_{Peak}$	Daily peak fuel savings	Calculated	Therms/day	
ΔkWh_{Life}	Lifetime electric energy savings	Calculated	kWh	
$\Delta Therms_{Life}$	Lifetime fuel savings	Calculated	Therms	
t_{fan}	Supply air fan runtime	Use one of the 4 scenarios in the description above	Hours	
CFM	Supply fan airflow	Site-specific	ft ³ /min	
ΔP	Additional pressure drop of the condensing heat exchanger of warm air furnace section	-0.15	Inch w.g.	[480]
$Eff_{fan,motor}$	Combined fan and motor efficiency	0.6	N/A	[480]
8,520 ⁸⁹	Conversion factor	8,520	N/A	
Q_{OA}	Annual outside air heating load per cfm of OA	Look up in Table 3-135 through Table 3-146	Btu/cfm	[480]
Eff_b	Baseline non condensing efficiency	Look up in Table 3-134	N/A	[481]
Eff_q	Efficient condensing efficiency	Site-specific. Use the same efficiency metric as Eff_b	N/A	
100,000	Conversion from Btu to therm	100,000	Btu/therm	
CF	Electric coincidence factor	Look up in Table 3-147	N/A	
PDF	Gas peak demand factor	Look up in Table 3-147	N/A	
EUL	Effective useful life	<u>See</u> Measure Life Section	Years	
RUL	Remaining useful life of existing unit	<u>See</u> Measure Life Section	Years	

⁸⁹ Fan horsepower (HP) calculation constant of 6,356 for standard air conditions adjusted by 1 HP = 0.746 kW, or (6,356 / 0.746) = 8,520 for this kW calculation.

Table 3-134 Furnace Baseline Efficiencies

Furnace Type	Size Category (kBtu input)	Standard 90.1-2019
Gas Fired	< 225	Nonweatherized 80% AFUE Weatherized 81% AFUE
Gas Fired	≥ 225	81% Et
Oil Fired	< 225	Nonweatherized excluding mobile home 83% AFUE Nonweatherized mobile home 75% AFUE Weatherized 78% AFUE
Oil Fired	≥ 225	82% Et

Table 3-135 8760 Annual Operation Scenario for HDD45

t _{fan} = 8760 Hours	Q _{oa} (Annual Btu/cfm)			
	At Supply Air Temperature Of			
Climate Zone - Weather Station/City	75°F	85°F	95°F	105°F
Northern	138,650	169,078	199,506	229,934
Southern	123,809	150,980	178,151	205,322
Coastal	76,756	93,601	110,446	127,291
Central	117,464	143,242	169,021	194,800
Pine Barrens	115,338	140,651	165,962	191,275

Table 3-136 8760 Hour Annual Operation Scenario for HDD55

t _{fan} = 8760 Hours	Q _{oa} (Annual Btu/cfm)			
	At Supply Air Temperature Of			
Climate Zone - Weather Station/City	75°F	85°F	95°F	105°F
Northern	182,976	227,595	272,214	316,833
Southern	166,370	206,940	247,510	288,079
Coastal	125,238	155,777	186,317	216,856
Central	162,154	201,695	241,236	280,777
Pine Barrens	160,335	199,433	238,531	277,628

Table 3-137 8760 Hour Annual Operation Scenario for HDD65

t _{fan} = 8760 Hours	Q _{oa} (Annual Btu/cfm)			
	At Supply Air Temperature Of			
Climate Zone - Weather Station/City	75°F	85°F	95°F	105°F

$t_{fan} = 8760$ Hours	Q_{oa} (Annual Btu/cfm)			
	At Supply Air Temperature Of			
Northern	218,007	280,807	343,606	406,405
Southern	201,016	258,922	316,827	374,732
Coastal	170,353	219,425	268,498	317,570
Central	198,527	255,715	312,904	370,091
Pine Barrens	196,445	253,034	309,623	366,211

Table 3-138 7300 Annual Operation Scenario for HDD45

$t_{fan} = 7300$ Hours	Q_{oa} (Annual Btu/cfm)			
	At Supply Air Temperature Of			
Climate Zone - Weather Station/City	75°F	85°F	95°F	105°F
Northern	111,241	135,739	160,237	184,734
Southern	99,334	121,210	143,085	164,960
Coastal	61,583	75,145	88,707	102,268
Central	94,243	114,998	135,752	156,506
Pine Barrens	92,538	112,917	133,296	153,674

Table 3-139 7300 Annual Operation Scenario for HDD55

$t_{fan} = 7300$ Hours	Q_{oa} (Annual Btu/cfm)			
	At Supply Air Temperature Of			
Climate Zone - Weather Station/City	75°F	85°F	95°F	105°F
Northern	146,885	182,811	218,738	254,664
Southern	133,554	166,220	198,886	231,552
Coastal	100,535	125,125	149,715	174,305
Central	130,169	162,007	193,845	225,683
Pine Barrens	128,709	160,190	191,671	223,152

Table 3-140 7300 Annual Operation Scenario for HDD65

$t_{fan} = 7300$ Hours	Q_{oa} (Annual Btu/cfm)			
	At Supply Air Temperature Of			
Climate Zone - Weather Station/City	75°F	85°F	95°F	105°F
Northern	174,841	225,198	275,554	325,911
Southern	161,214	207,647	254,079	300,512
Coastal	136,622	175,972	215,321	254,671

$t_{fan} = 7300$ Hours	Q_{oa} (Annual Btu/cfm)			
	At Supply Air Temperature Of			
Central	159,218	205,075	250,932	296,790
Pine Barrens	157,549	202,925	248,301	293,678

Table 3-141 5266 Annual Operation Scenario for HDD45

$t_{fan} = 5266$ Hours	Q_{oa} (Annual Btu/cfm)			
	At Supply Air Temperature Of			
Climate Zone - Weather Station/City	75°F	85°F	95°F	105°F
Northern	76,284	93,254	110,223	127,194
Southern	68,118	83,272	98,425	113,579
Coastal	42,231	51,625	61,019	70,414
Central	64,627	79,004	93,381	107,758
Pine Barrens	63,458	77,575	91,691	105,808

Table 3-142 5266 Annual Operation Scenario for HDD55

$t_{fan} = 5266$ Hours	Q_{oa} (Annual Btu/cfm)			
	At Supply Air Temperature Of			
Climate Zone - Weather Station/City	75°F	85°F	95°F	105°F
Northern	100,163	124,786	149,408	174,031
Southern	91,073	113,461	135,848	158,237
Coastal	68,557	85,409	102,262	119,115
Central	88,765	110,585	132,405	154,226
Pine Barrens	87,769	109,345	130,920	152,496

Table 3-143 5266 Annual Operation Scenario for HDD65

$t_{fan} = 5266$ Hours	Q_{oa} (Annual Btu/cfm)			
	At Supply Air Temperature Of			
Climate Zone - Weather Station/City	75°F	85°F	95°F	105°F
Northern	119,326	153,797	188,268	222,738
Southern	110,026	141,810	173,595	205,378
Coastal	93,242	120,178	147,114	174,049
Central	108,663	140,054	171,445	202,835
Pine Barrens	107,524	138,586	169,647	200,708

Table 3-144 3911 Annual Operation Scenario for HDD45

t _{fan} = 3911 Hours	Q _{oa} (Annual Btu/cfm)			
	At Supply Air Temperature Of			
Climate Zone -	75°F	85°F	95°F	105°F
Weather Station/City				
Northern	54,942	67,170	79,398	91,626
Southern	49,061	59,980	70,900	81,819
Coastal	30,416	37,185	43,955	50,724
Central	46,546	56,906	67,266	77,625
Pine Barrens	45,704	55,876	66,049	76,221

Table 3-145 3911 Annual Operation Scenario for HDD55

t _{fan} = 3911 Hours	Q _{oa} (Annual Btu/cfm)			
	At Supply Air Temperature Of			
Climate Zone -	75°F	85°F	95°F	105°F
Weather Station/City				
Northern	72,525	90,433	108,340	126,247
Southern	65,943	82,225	98,507	114,789
Coastal	49,640	61,896	74,153	86,410
Central	64,272	80,141	96,011	111,880
Pine Barrens	63,551	79,242	94,934	110,625

Table 3-146 3911 Annual Operation Scenario for HDD65

t _{fan} = 3911 Hours	Q _{oa} (Annual Btu/cfm)			
	At Supply Air Temperature Of			
Climate Zone -	75°F	85°F	95°F	105°F
Weather Station/City				
Northern	87,018	112,390	137,763	163,136
Southern	80,236	103,631	127,026	150,422
Coastal	67,996	87,823	107,649	127,476
Central	79,242	102,348	125,453	148,559
Pine Barrens	78,411	101,275	124,138	147,001

Peak Factors

Table 3-147 Peak Factors

Peak Factor	Value	Ref
Electric coincidence factor (CF)	1	[480]

Peak Factor	Value	Ref
Natural gas peak day factor (PDF)	See Appendix G: Natural Gas Peak Day Factors	

Measure Life

The remaining useful life (RUL) for existing equipment is limited to 1/3 of the effective useful life (EUL) of the equipment.

Table 3-148 Measure Life

Equipment	EUL	RUL	Ref
Make-up Air Unit	15	5	[482]

References

- [480] 2022 Illinois Statewide Technical Reference Manual for Energy Efficiency V10: Volume 2 Commercial and Industrial Measures. (2021), Pg 405-412, https://www.ilsag.info/wp-content/uploads/IL-TRM_Effective_010122_v10.0_Vol_2_C_and_I_09242021.pdf.
- [481] ASHRAE Standard 90.1-2019, Energy Standard for Buildings Except Low-Rise Residential Buildings. (ASHRAE, 2019), Table 6.8.1-5, <https://www.ashrae.org/technical-resources/standards-and-guidelines/read-only-versions-of-ashrae-standards>.
- [482] DEER 2014 EUL http://www.deeresources.com/files/DEER2013codeUpdate/download/DEER2014-EUL-table-update_2014-02-05.xlsx.

3.5.10 HEAT OR ENERGY RECOVERY VENTILATOR

Market	Commercial
Baseline Condition	NC/RF/TOS
Baseline	Code/Existing
End Use Subcategory	Heat Recovery
Measure Last Reviewed	January 2023

Description

This measure covers the installation of Energy Recovery Ventilators (ERV) and Heat Recovery Ventilators (HRV). ERVs and HRVs reduce heating and cooling loads while maintaining required ventilation rates by facilitating heat transfer between outgoing conditioned air and incoming outdoor air. ERVs and HRVs employ air-to-air heat exchangers to recover energy from exhaust air for the purpose of pre-conditioning outdoor air prior to supplying the conditioned air to the space, either directly or as part of an air-conditioning system. For new construction, this measure only applies in cases where ERV/HRV functionality is not required by federal, state, local or municipal codes or standards. This measure is also applicable to retrofit of existing buildings. For the purposes of this measure, ERVs and HRVs are distinguished as follows:

- Energy Recovery Ventilator (ERV): Transfers both sensible (heat content) and latent (moisture content) heat between supply and exhaust airstreams.
- Heat Recovery Ventilator (HRV): Transfers sensible heat only between supply and exhaust airstreams.

Baseline Case

The baseline condition for this measure is a commercial or multi-family high-rise building with an ASHRAE 62.2-compliant exhaust fan system with no heat or energy recovery.

Efficient Case

The compliance condition for this measure is a commercial or multi-family high-rise building with an ASHRAE 62.2-compliant exhaust fan system equipped with AHRI certified ERV or HRV components.

Annual Energy Savings Algorithms

Annual Electric Energy Savings

$$\Delta kWh = \Delta kWh_c + \Delta kWh_h + \Delta kWh_{fan}$$

Cooling energy savings:

For ERVs:

$$\Delta kWh_c = \frac{4.5 \times CFM \times Eff_{hx,total} \times (H_{outdoor,c} - H_{indoor,c})}{1,000 \times Eff_{elec,c}} \times hrs_c$$

For HRVs:

$$\Delta kWh_c = \frac{1.08 \times CFM \times Eff_{hx,sens} \times (T_{outdoor,c} - T_{indoor,c})}{1,000 \times Eff_{elec,c}} \times hrs_c$$

Heating energy savings (both ERVs and HRVs):

$$\Delta kWh_h = \frac{1.08 \times CFM \times Eff_{hx,sens} \times (T_{indoor,h} - T_{outdoor,h})}{1,000 \times HSPF} \times F_{ElecHeat} \times hrs_h$$

Fan energy savings:

$$\Delta kWh_{fan} = (kW_{fan,b} - kW_{fan,q}) \times (hrs_h + hrs_c)$$

Calculate baseline and qualifying fan kW as follows.⁹⁰ Use first equation if values are known, otherwise use second equation:

$$kW_{fan} = \sum \left(\frac{CFM \times \Delta P}{33,013/5.202 \times Eff_{fan,mech} \times Eff_{fan,motor}} \times 0.746 \right)$$

$$kW_{fan} = \sum \left(\frac{HP \times LF}{Eff_{fan,motor}} \times 0.746 \right)$$

Annual Fuel Savings

$$\Delta Therms = \frac{1.08 \times CFM \times Eff_{hx,sens} \times (T_{indoor,h} - T_{outdoor,h})}{100,000 \times Eff_{fuel,h}} \times F_{FuelHeat} \times hrs_h$$

Summer Peak Demand Savings

For ERVs:

$$\Delta kW_{Peak} = \left(\frac{4.5 \times CFM \times Eff_{hx,total} \times (H_{outdoor,c,peak} - H_{indoor,c})}{1,000 \times EER} + (kW_{fan,b} - kW_{fan,q}) \right) \times CF$$

For HRVs:

$$\Delta kW_{Peak} = \left(\frac{1.08 \times CFM \times Eff_{hx,sense} \times (T_{outdoor,c,peak} - T_{indoor,c})}{1,000 \times EER} + (kW_{fan,b} - kW_{fan,q}) \right) \times CF$$

⁹⁰ Represents total electric power of ERV/HRV supply and exhaust fans (kW). Sigma operator included to indicate that this term shall include consideration of all ERV/HRV fans.

Daily Peak Fuel Savings

$$\Delta Therms_{Peak} = \Delta Therms \times PDF$$

Lifetime Energy Savings Algorithms

Lifetime Electric Energy Savings

$$\Delta kWh_{Life} = \Delta kWh \times EUL$$

Lifetime Fuel Savings

$$\Delta Therms_{Life} = \Delta Therms \times EUL$$

Calculation Parameters

Table 3-149 Calculation Parameters

Variable	Description	Value	Units	Ref
ΔkWh	Annual electric energy savings	Calculated	kWh/yr	
$\Delta Therms$	Annual fuel savings	Calculated	Therms/yr	
ΔkW_{Peak}	Peak Demand Savings	Calculated	kW	
$\Delta therms_{Peak}$	Daily peak fuel savings	Calculated	Therms/day	
ΔkWh_{Life}	Lifetime electric energy savings	Calculated	kWh	
$\Delta therms_{Life}$	Lifetime fuel savings	Calculated	Therms	
ΔkWh_c	Annual electric energy savings during cooling season	Calculated	kWh	
ΔkWh_h	Annual electric energy savings during heating season	Calculated	kWh	
ΔkWh_{fan}	Annual electric energy savings due to fan operation	Calculated	kWh	
$kW_{fan,b}$	Total electric power of baseline supply and exhaust fans	Calculated	kW	
$kW_{fan,q}$	Total electric power of efficient supply and exhaust fans	Calculated	kW	
CFM	Volume of supply air	Site-specific	Ft ³ /min	
$Eff_{hx,total}$	Total effectiveness of heat exchanger per rating in accordance with AHRI Standard 1060	Site-specific	N/A	[483]

Variable	Description	Value	Units	Ref
$Eff_{hx,sens}$	Sensible effectiveness of heat exchanger per rating in accordance with AHRI Standard	Site-specific	N/A	[483]
$Eff_{elec,c}$	Seasonal average energy efficiency of electric cooling equipment (SEER or IEER)	Site-specific, if unknown look up in Appendix E: Code-Compliant Efficiencies for equipment type and size	Btu/watt-hour	[484]
EER	Energy efficiency ratio of electric cooling equipment ⁹¹	Site-specific, if unknown look up in Appendix E: Code-Compliant Efficiencies for equipment type and size	Btu/watt-hour	
HSPF	Heating seasonal performance factor of electric heating equipment ⁹²	Site-specific, if unknown look up in Appendix E: Code-Compliant Efficiencies for equipment type and size	Btu/watt-hour	
$Eff_{fuel,h}$	Efficiency of fossil fuel heating equipment (AFUE, E_t or E_c)	Site-specific, if unknown look up in Appendix E: Code-Compliant Efficiencies for equipment type and size	N/A	
$T_{indoor,h}$	Indoor heating setpoint temperature	Site-specific, if unknown use 70°F	°F	
$T_{indoor,c}$	Indoor cooling setpoint temperature	Site-specific, if unknown use 70°F	°F	
H_{indoor}	Enthalpy of indoor air	Look up in Table 3-150 based on T_{indoor}	Btu/lb	
$Eff_{fan,mech}$	Mechanical efficiency of ERV fans	Site-specific, if unknown use 0.67	N/A	[485]
$Eff_{fan,motor}$	Efficiency of ERV fan motors	Site-specific, if unknown use 0.7 ⁹³	N/A	[486]
ΔP	Pressure drop at nominal airflow in the ERV as rated in accordance with AHRI Standard 1060	Site-specific	Inches of H ₂ O	
HP	Total fan horsepower	Site-specific	HP	
LF	Load factor	Site-specific, if unknown use 0.92	N/A	[491]
hrs_c	Operating hours in the cooling season	Look up in Table 3-151	hrs	[489]
hrs_h	Operating hours in the heating season	Look up in Table 3-151	hrs	[489][125]

⁹¹ For equipment rated in EER2, use EER2. If unknown, calculate EER as follows:

$$EER = (1.12 \times SEER) - (0.02 \times SEER^2)$$

⁹² If needed, convert COP to HSPF as follows:

$$HSPF = COP \times 3.412$$

⁹³ Based on ¼ hp, 4-pole polyphase motor. 10 CFR 431.446

Variable	Description	Value	Units	Ref
$H_{\text{outdoor,c}}$	Enthalpy of outside air during cooling	Look up in Table 3-152	Btu/lb	[490]
$H_{\text{outdoor,h}}$	Enthalpy of outside air during heating	Look up in Table 3-152	Btu/lb	[490]
$T_{\text{outdoor,c}}$	Avg. outdoor temperature during cooling season.	Look up in Table 3-152	°F	[490]
$T_{\text{outdoor,h}}$	Avg. outdoor temperature during heating season	Look up in Table 3-152	°F	[490]
$T_{\text{outdoor,c,peak}}$	Peak outdoor temperature during cooling season	Look up in Table 3-153	°F	[492]
$H_{\text{outdoor,c,peak}}$	Peak Enthalpy of outdoor air during cooling season	Look up in Table 3-153	°F	[492]
F_{ElecHeat}	Electric heating factor, to account for presence of electric heat	Use 1 if electric heat, otherwise use 0	N/A	
F_{FuelHeat}	Fuel heating factor, to account for presence of fuel heat	Use 1 if fuel heat, otherwise use 0	N/A	
1.08	Specific heat of air × density of inlet air @ 70°F × 60 min/hr	1.08	BTU/h.°F.CFM	
4.5	Density of inlet air at 70 °F x 60 min/hr	4.5	Lb.min/ft ³ .hr	
60	Minutes per hour	60	Min/hr	
1,000	Conversion factor, one kW equals 1,000 Watts	1,000	kW/W	
100,000	Conversion from Btu to therms	100,000	Btu/therm	
0.746	Conversion from horsepower to kW	0.746	kW/HP	
33,013	Conversion factor from horsepower to ft.lb/min	33,013	(ft.lb/min)/hp	
5.202	Conversion factor from inches of water to pounds per square ft	5.202	lb/ft ² / inH ₂ O	
CF	Electric coincidence factor	Look up in Table 3-154	N/A	
PDF	Gas peak day factor	Look up in Table 3-154	N/A	
EUL	Effective useful life	See Measure Life Section	Years	

Table 3-150 Indoor Enthalpy

Temperature, T_{indoor} (°F)	Enthalpy, H_{indoor} at 50% Relative Humidity (Btu/lb)
65	22.7
66	23.2
67	23.7
68	24.2
69	24.8
70	25.3
71	25.8
72	26.4
73	27.0
74	27.5
75	28.1
76	28.7
77	29.3
78	29.9

Table 3-151 Heating and Cooling Hours⁹⁴

NJ Climate Region	Heating Hours, hrs_h	Cooling Hours, hrs_c
Northern	4,970	1,670
Southern	4,896	1,783
Coastal	4,981	1,954
Central	4,969	1,810
Pine Zones	4,899	1,828
Statewide Average	4,953	1,820

⁹⁴ Calculated from TMY3 data for representative weather stations for each NJ climate zone. Cooling hours are defined as any hour when outdoor air temperature is above 65°F for the months of June through August and heating hours are defined as any hour when outdoor air temperature is below 65°F for the months of October through April. The heating and cooling hours above represent the count of each in a typical meteorological year. Note: these values may over-estimate hours for buildings with limited operating hours such as offices, schools, etc. Site-specific estimate should be used when possible.

Table 3-152 Outdoor Air Temperature and Enthalpy⁹⁵

NJ Climate Region	Relative Humidity ⁹⁶ (%)	Avg. outdoor temperature ⁹⁷ during cooling season, T _{outdoor,c} (°F)	Avg. outdoor temperature ⁹⁷ during heating season, T _{outdoor,h} (°F)	Avg enthalpy ⁹⁸ of outdoor air at duing cooling season, H _{outdoor,c} (Btu/lb)	Avg enthalpy ⁹⁸ of outdoor air at duing cooling season, H _{outdoor,c} (Btu/lb)
Northern	69.77	74.60	42.10	32.05	14.39
Southern	67.39	74.50	42.70	31.51	14.49
Coastal	74.63	73.00	46.20	31.87	16.47
Central	75.77	74.30	43.20	33.09	15.23
Pine Barrens	74.34	73.70	43.40	32.33	15.22
Statewide Average	72.61	73.91	43.82	32.14	15.31

Table 3-153 Peak Outdoor Air Temperature and Enthalpy

NJ Climate Region	Peak outdoor temperature during cooling season, T _{outdoor,c,peak} (°F)	Peak Enthalpy of outdoor air at duing cooling season, H _{outdoor,c,peak} (Btu/lb)
Northern	89	40.24
Southern	93	42.28
Coastal	90	41.26
Central	93	42.28
Pine Barrens	94	41.22
Statewide Average	91	41.32

⁹⁶ Average of NOAA hourly relative humidity from January 2020 – December 2022 for each climate zone representative weather station (Northern = Allentown, PA; Southern = Philadelphia, PA; Coastal = Atlantic City, NJ; Central = Trenton, NJ; Pine Barrens = McGuire Air Force Base, NJ)

⁹⁷ Calculated from TMY3 data for representative weather stations for each NJ climate zone. Cooling hours are defined as any hour when outdoor air temperature is above 65°F for the months of June through August and heating hours are defined as any hour when outdoor air temperature is below 65°F for the months of October through April. The average heating and cooling temperatures are the average temperature of these hours for the typical meteorological year.

⁹⁸ Calculated via ASHRAE Dayton’s online psychrometric tool, using the average NJ elevation of 228 ft above sea level.

https://daytonashrae.org/psychrometrics/psychrometrics_imp.html#start

Peak Factors

Table 3-154 Peak Factors

Peak Factor	Value	Ref
Electric coincidence factor (CF)	0.69	[123]
Natural gas peak day factor (PDF)	N/A	

Measure Life

The effective useful life (EUL) is 14 years [124].

References

- [483] *Performance Rating of air-to-air exchanges for Energy Recovery Ventilation Equipment*, (AHRI, 2018). https://www.ahrinet.org/sites/default/files/2022-06/AHRI_Standard_1061_SI_2018.pdf
- [484] 10 CFR 430.32 (c)(1) , December 2022. <https://www.ecfr.gov/current/title-10/chapter-II/subchapter-D/part-430>
- [485] ASHRAE 90.1 2013, Section 6.5.3.1.3, June 2014. <http://arkanarzesh.com/wp-content/uploads/2016/09/ASHRAE%2090.1-2013%20%20-IP.pdf>
- [486] 10 CFR 431.446 , December 2022. <https://www.ecfr.gov/current/title-10/chapter-II/subchapter-D/part-431>
- [487] Based on BG&E ‘Development of Residential Load Profile for Central Air Conditioners and Heat Pumps’ research, the Maryland Peak Definition coincidence factor is 0.69. This study is not publicly available, but is referenced by M. M. Straub, Using Available Information for Efficient Evaluation of Demand-Side Management Programs, Electricity Journal, and supported by research conducted by Cadmus on behalf of the RM Management Committee, September 2011.
- [488] PA Consulting Group Inc., Focus on Energy Evaluation Business Programs: Measure Life Study, final report, August 2009 https://focusonenergy.com/sites/default/files/bpmeasurelifestudyfinal_evaluationreport.pdf
- [489] ONJSC: Monthly/Annual Temperature Normals (1991-2020), December 2022 http://climate.rutgers.edu/stateclim_v1/norms/monthly/index.html.
- [490] NSRDB, TMY3 data, December 2022. <https://nsrdb.nrel.gov/data-sets/tmy>
- [491] *Proposed Standard Savings Estimation Protocol for Ultra-Premium Efficiency Motors*, Cascade Energy, November 5, 2012. Table 6: Load Factor by Nameplate hp and End Use. November 5, 2012
- [492] ASHRAE Fundamentals 2021 - Chapter 14 Climactic Design Conditions - <https://handbook.ashrae.org/Handbook.aspx#>

3.5.11 DEMAND CONTROLLED VENTILATION

Market	Commercial
Baseline Condition	RF/DI
Baseline	Existing/Dual
End Use Subcategory	Control
Measure Last Reviewed	January 2023

Description

Maintaining acceptable air quality requires standard ventilation systems designers to determine ventilation rates based on maximum estimated occupancy levels and published CFM/occupant requirements. During low occupancy periods, this approach results in higher ventilation rates than are required to maintain acceptable levels of air quality. This excess ventilation air must be conditioned and therefore results in wasted energy.

Building occupants exhale CO₂, and the CO₂ concentration in the air increases in proportion to the number of occupants. The CO₂ concentration provides a good indicator of overall air quality. Demand control ventilation (DCV) systems monitor indoor air CO₂ concentrations and use this data to automatically modulate dampers and regulate the amount of outdoor air that is supplied for ventilation. DCV is most suited for facilities where occupancy levels are known to fluctuate considerably.

Saving factors were calculated based on IL TRM values for Chicago, adjusted by ratio of Degree Days for each listed NJ Climate Zone and Chicago, based on TMY 3 Data using base 65 F balance point. See the 'Demand Controlled Ventilation' Section of the Illinois Statewide Technical Reference Manual V11 for further explanation [1].

Baseline Case

The baseline system is an existing cooling and heating systems with no demand control ventilation or ventilation heat recovery equipment installed.

Efficient Case

The compliance condition is a DCV system added to the return air system to supply air based on occupancy demands.

Annual Energy Savings Algorithms

Annual Electric Energy Savings

$$\Delta kWh = \frac{A}{1,000} \times SF_{ElecCool} + \frac{A}{1,000} \times SF_{ElecHeat} \times F_{ElecHeat}$$

Annual Fuel Savings

$$\Delta Therms = \frac{A}{1,000} \times SF_{fuel} \times F_{FuelHeat}$$

Peak Demand Savings

$$\Delta kW_{Peak} = N/A$$

Daily Peak Fuel Savings

$$\Delta Therms_{Peak} = \Delta Therms \times PDF$$

Lifetime Energy Savings Algorithms

Lifetime Electric Energy Savings

$$\Delta kWh_{Life} = \Delta kWh \times EUL$$

Lifetime Fuel Savings

$$\Delta Therms_{Life} = \Delta Therms \times EUL$$

Dual:

Lifetime Electric Energy Savings

$$\Delta kWh_{Life} = \Delta kWh_{EREP} \times RUL + \Delta kWh_{NR} \times EUL$$

Lifetime Fuel Savings

$$\Delta Therms_{Life} = \Delta Therms_{EREP} \times RUL + \Delta Therms_{NR} \times EUL$$

Calculation Parameters

Table 3-155 Calculation Parameters

Variable	Description	Value	Units	Ref
ΔkWh	Annual electric energy savings	Calculated	kWh/yr	
$\Delta Therms$	Annual fuel savings	Calculated	Therms/yr	
$\Delta Therms_{Peak}$	Daily peak fuel savings	Calculated	Therms/day	
ΔkWh_{Life}	Lifetime electric energy savings	Calculated	kWh	
$\Delta Therms_{Life}$	Lifetime fuel savings	Calculated	Therms	
A	Total area square footage of the conditioned space impacted by the measure	Site-specific	Ft ²	
$SF_{ElecCool}$	DCV energy savings factor for cooling	Look up in Table 3-156	kWh/1,000 ft ²	[1]
$SF_{ElecHeat}$	DCV energy savings factor for electric heating	Look up in Table 3-157, Table 3-158	kWh/1,000 ft ²	[1]
$F_{elecHeat}$	Electric heating factor, used to account for the presence or absence of an electric heating system	1 (if electric heat) 0 (otherwise)	N/A	

Variable	Description	Value	Units	Ref
SF _{Fuel}	DCV fuel savings factor for heating	Look up in Table 3-159	Therms/1,000 ft ²	[1]
F _{FuelHeat}	Fuel heating factor, used to account for the presence or absence of a fossil fuel heating system	1 (if fossil fuel heat) 0 (otherwise)	N/A	
CF	Electric coincidence factor	Look up in Table 3-160	N/A	
PDF	Gas peak day factor	Look up in Table 3-160	N/A	
10	Unit conversion, Therm/MMBtu	10	Therm/MMBtu	
EUL	Effective useful life	See Measure Life Section	Years	[2]
RUL	Remaining useful life of existing unit	See Measure Life Section	Years	

Table 3-156 Energy Savings Factor for Cooling (kWh/1,000 ft²)

Building Type	North	Coastal	Central	Pine Barrens	Southwest	Statewide Average ⁹⁹
Office - Low-rise (1 to 3 Stories)	267	362	368	366	359	334
Office - Mid-rise (4 to 11 Stories)	211	286	291	289	283	264
Office - High-rise (12+ Stories)	250	340	345	344	337	314
Religious Building	720	978	994	989	970	903
Restaurant	471	640	650	647	634	590
Retail - Department Store	363	493	501	498	489	455
Retail - Strip Mall	251	341	347	345	338	315
Convenience Store	330	448	455	453	444	413
Elementary School	339	460	468	465	456	425
High School	332	450	457	455	446	415
College/ University	393	534	543	540	530	493
Healthcare Clinic	327	444	451	449	440	410
Lodging (Hotel/Motel)	378	513	521	518	508	473
Manufacturing	163	222	226	224	220	205
Special Assembly Auditorium	537	729	740	737	722	672

⁹⁹ Weighted average based on NJ climate zone distribution.

Building Type	North	Coastal	Central	Pine Barrens	Southwest	Statewide Average ⁹⁹
Other	356	483	491	488	479	446
Enclosed Parking Garage	854	1,160	1,179	1,173	1,150	1070

Table 3-157 Electric Heating Savings with Heat Pump (kWh/1,000 ft²)

Building Type	North	Coastal	Central	Pine Barrens	Southwest	Statewide Average ⁹⁹
Office - Low-rise (1 to 3 Stories)	185	149	163	158	163	167
Office - Mid-rise (4 to 11 Stories)	125	100	110	106	109	112
Office - High-rise (12+ Stories)	167	135	147	143	147	151
Religious Building	1,206	970	1,062	1,028	1,057	1,087
Restaurant	870	700	767	742	763	785
Retail - Department Store	298	239	262	254	261	268
Retail - Strip Mall	194	156	171	166	171	175
Convenience Store	147	119	130	126	129	133
Elementary School	517	416	456	441	454	467
High School	505	406	445	430	443	455
College/ University	1007	811	888	859	884	909
Healthcare Clinic	358	288	316	305	314	323
Lodging (Hotel/Motel)	166	134	147	142	146	150
Manufacturing	103	83	91	88	90	93
Special Assembly Auditorium	1,414	1,138	1,246	1,207	1,241	1,276
Other	484	389	426	413	424	436
Enclosed Parking Garage	185	149	163	158	163	167

Table 3-158 Electric Heating Savings with Electrical Resistance (kWh/1,000 ft²)

Building Type	North	Coastal	Central	Pine Barrens	Southwest
Office - Low-rise (1 to 3 Stories)	556	448	490	474	488
Office - Mid-rise (4 to 11 Stories)	374	301	329	319	328
Office - High-rise (12+ Stories)	501	403	441	427	439
Religious Building	3617	2910	3186	3085	3172

Building Type	North	Coastal	Central	Pine Barrens	Southwest
Restaurant	2610	2100	2300	2226	2289
Retail - Department Store	893	718	786	761	783
Retail - Strip Mall	584	470	515	498	512
Convenience Store	441	355	389	376	387
Elementary School	1551	1248	1367	1323	1360
High School	1513	1218	1333	1291	1327
College/ University	3022	2432	2662	2577	2650
Healthcare Clinic	1074	865	947	916	942
Lodging (Hotel/Motel)	498	401	439	425	437
Manufacturing	310	250	273	265	272
Special Assembly Auditorium	4242	3414	3738	3619	3721
Other	1452	1169	1280	1239	1274

Table 3-159 Fuel Heating Savings (therms/1000 SF)

Building Type	North	Coastal	Central	Pine Barrens	Southwest
Office - Low-rise (1 to 3 Stories)	24	19	21	20	21
Office - Mid-rise (4 to 11 Stories)	16	13	14	14	14
Office - High-rise (12+ Stories)	22	17	19	19	19
Religious Building	155	124	136	132	136
Restaurant	111	90	98	95	98
Retail - Department Store	38	31	33	32	33
Retail - Strip Mall	25	20	22	22	22
Convenience Store	19	15	17	16	17
Elementary School	66	53	58	56	58
High School	64	52	57	55	56
College/ University	129	104	114	110	113
Healthcare Clinic	46	37	41	39	40
Lodging (Hotel/Motel)	21	17	18	18	18
Manufacturing	14	11	12	12	12
Special Assembly Auditorium	181	146	159	154	159
Other	61	49	54	52	54

Peak Factors

Table 3-160 Peak Factors

Peak Factor	Value	Ref
Electric coincidence factor (CF)	N/A	
Natural gas peak day factor (PDF)	See Appendix G: Natural Gas Peak Day Factors	

Measure Life

Use the smaller of the measure life (10 yr) or the remaining useful life (RUL) of host equipment [2]. If applied to a packaged HVAC system, the RUL of the host equipment is 5 years.

References

- [1] *2023 Illinois Statewide Technical Reference Manual for Energy Efficiency Version 11 Volume 2: Commercial and Industrial Measures* (September 2022), Pg 357, https://www.ilsag.info/wp-content/uploads/IL-TRM_Effective_010123_v11.0_Vol_2_C_and_I_092222_FINAL.pdf
- [2] ERS (2005). *Measure Life Study prepared for The Massachusetts Joint Utilities*.

3.5.12 DEMAND CONTROLLED KITCHEN VENTILATION

Market	Commercial
Baseline Condition	RF
Baseline	Existing
End Use Subcategory	Control
Measure Last Reviewed	January 2023

Description

Installation of variable speed drives (VSD) on commercial kitchen exhaust fans and make-up air fans allows the variation of ventilation based on cooking load and/or time of day. This measure is targeted to non-residential customers whose kitchen exhaust fans and make-up air fans are equipped with a VSD that varies the exhaust rate of kitchen ventilation based on the energy and effluent output from the cooking appliances (i.e., the more heat and smoke/vapors generated, the more ventilation needed). This involves installing a temperature sensor in the hood exhaust collar and/or an optic sensor on the end of the hood that sense cooking conditions which allows the system to automatically vary the rate of exhaust to what is needed by adjusting the fan speed.

Baseline Case

The baseline equipment is a constant speed commercial kitchen ventilation system.

Efficient Case

The energy efficient condition is a commercial kitchen ventilation system equipped with a VSD and demand ventilation controls and sensors.

Annual Energy Savings Algorithms

Annual Electric Energy Savings

$$\Delta kWh = \Delta kWh_{fan} + \Delta kWh_{cooling}$$

$$\Delta kWh_{fan} = \left(\frac{CFM}{1400} \right) \times Hours \times Days \times Weeks \times \sum_{0\%}^{100\%} \%FF \times PLR$$

$$\Delta kWh_{cooling} = SF_{cool} \times \%MUA_{cool} \times \Delta kWh_{fan}$$

Annual Fuel Savings

$$\Delta Therms = SF_{heat} \times \Delta kWh_{fan} \times 10$$

Peak Demand Savings

$$\Delta kW_{Peak} = \left(\frac{\Delta kWh}{Hours \times Days \times Weeks} \right) \times CF$$

Daily Peak Fuel Savings

$$\Delta Therms_{Peak} = \Delta Therms \times PDF$$

Lifetime Energy Savings Algorithms

Lifetime Electric Energy Savings

$$\Delta kWh_{Life} = \Delta kWh \times EUL$$

Lifetime Fuel Savings

$$\Delta Therms_{Life} = \Delta Therms \times EUL$$

Calculation Parameters

Table 3-161 Calculation Parameters

Variable	Description	Value	Units	Ref
ΔkWh	Annual electric energy savings	Calculated	kWh/yr	
$\Delta Therms$	Annual fuel savings	Calculated	Therms/yr	
ΔkW_{Peak}	Peak Demand Savings	Calculated	kW	
$\Delta Therms_{Peak}$	Daily peak fuel savings	Calculated	Therms/day	
ΔkWh_{Life}	Lifetime electric energy savings	Calculated	kWh	
$\Delta Therms_{Life}$	Lifetime fuel savings	Calculated	Therms	
CFM	Uncontrolled design hood exhaust flow in cubic feet per minute.	Site-specific If actual flow is unknown, estimate flow from hood dimensions. For unlisted hoods estimate 100 CFM per square foot of plan area. For UL listed hoods estimate 250 CFM per length of hood in feet.	cfm	[6]
1,400	Estimation of CFM delivered per kW consumed from both exhaust and make-up air fan motor	1,400	Cfm/kW	[4]
Hours	Hours per day hood is operated	Site-specific, if actual hours are unknown assume 5 hours per meal served.	hrs	[6]
Days	Number of days kitchen is in operation per week	Site-specific	Days	
Weeks	Number of weeks kitchen is in operation	Site-specific, if actual weeks are unknown assume 50 weeks per year.	Weeks	[6]

Variable	Description	Value	Units	Ref
%FF	Percentage of run-time spent within a given flow fraction range	Site-specific, if actual values unknown assume 30% of time at full flow, 30% of time at 75% flow, and 40% of time at 50% flow	N/A	[6]
PLR	Part load ratio for a given flow fraction range	Look up Table 3-162	N/A	
SF_{cool}	Cooling savings factor	0.471	N/A	[5]
$\%MUA_{cool}$	During the cooling season, the percentage of make-up air that is conditioned	If kitchen is cooled, then %MUA = 1.0. If kitchen is not cooled, then must calculate the percentage of make-up air that is being pulled from the dining room or other conditioned space. = If actual value is unknown, then assume 30%, or 0.3.	N/A	[6]
SF_{heat}	Heating savings factor	Lookup Table 3-163. If percent of make-up air from dining room is unknown, assume 30% from dining room	MMBtu/kWh	[5]
CF	Electric coincidence factor	Look up in Table 3-164	N/A	
PDF	Gas peak day factor	Look up in Table 3-164	N/A	
EUL	Effective useful life	See Measure Life Section	Years	

Table 3-162 Part Load Ratios by Control and Fan Type and Flow Fraction (PLR)

Control Type	Flow Fraction									
	10%	20%	30%	40%	50%	60%	70%	80%	90%	100%
VFD	0.09	0.10	0.11	0.15	0.20	0.28	0.41	0.57	0.77	1.00

Table 3-163 Heating Savings Factor (SF_{Heat})

Percent of Make-up Air from Nearby Conditioned Space (Dining Room)	Make-up Air Directly Supplied to Kitchen is NOT Heated	Make-up Air Directly Supplied to Kitchen is Heated
0%	0	0.0088
10%	0.0013	0.0093
20%	0.0026	0.0097
30%	0.0039	0.0101
40%	0.0042	0.0105
50%	0.0065	0.0109
60%	0.0078	0.0113
70%	0.0091	0.0118

Percent of Make-up Air from Nearby Conditioned Space (Dining Room)	Make-up Air Directly Supplied to Kitchen is NOT Heated	Make-up Air Directly Supplied to Kitchen is Heated
80%	0.0104	0.0122
90%	0.0117	0.0126
100%	0.0130	0.0130

Peak Factors

Table 3-164 Peak Factors

Peak Factor	Value	Ref
Electric coincidence factor (CF)	1.0 if kitchen operates during dinner 0.0 if the kitchen does not operate during dinner	
Natural gas peak day factor (PDF)	See Appendix G: Natural Gas Peak Day Factors	

Measure Life

The effective useful life (EUL) is 15 years. [3]

References

- [3] California Public Utilities Commission Database for Energy Efficient Resources (DEER) EUL Support Table for 2020, <http://www.deeresources.com/files/DEER2020/download/SupportTable-EUL2020.xlsx>.
- [4] Estimation of CFM delivered per kW consumed from both exhaust and make-up air fan motor. Derived from proprietary Navigant DCKW tool.
- [5] Savings factor calculated from proprietary Navigant DCKW tool using TMY3 temperature data from Baltimore, MD. The tool does a bin hour calculation of the cooling energy required to condition make-up air.
- [6] *Mid-Atlantic Technical Reference Manual: Version 10* (May 2020), <https://neep.org/mid-atlantic-technical-reference-manual-trm-v10>, Pg 404

3.5.13 EC MOTORS

Market	Commercial
Baseline Condition	RF
Baseline	Existing
End Use Subcategory	Motor
Measure Last Reviewed	December 2022

Description

This measure covers the retrofit installation of an Electronically Commuted (EC) motor to replace an existing HVAC supply fan motor or hydronic circulator pump motor.

This measure is not applicable to exhaust fan motors. New construction and replace-on-burnout scenarios are not eligible because ECM technology is required in new equipment by federal efficiency standards [7].

Interactive factors should be applied for motors that supply cooling or heating to account for the reduced cooling load, or increased heating load, associated with the lower wattage ECM motor. Interactive factors do not apply if the motor is located outside of the conditioned air or hydronic pathway.

Baseline Case

An existing HVAC fan or pump with a single-speed, shaded-pole (SP) or permanent-split capacitor (PSC) motor. Baseline wattage should be derived from the nameplate rating of the existing motor.

Efficient Case

HVAC fan or pump with an Electronically Commuted (EC) Motor

Annual Energy Savings Algorithm

Annual Electric Energy Savings

$$\Delta kWh = \Delta kWh_h + \Delta kWh_c$$

For blower fans:

$$\Delta kWh_h = \frac{(W_b \times ESF_h)}{1,000} \times LF \times Hrs_h \times (1 - HVAC_e)$$

$$\Delta kWh_c = \frac{(W_b \times ESF_c)}{1,000} \times LF \times Hrs_c \times (1 + HVAC_e)$$

For circulator pumps:

$$\Delta kWh_h = \frac{(W_b - W_q)}{1,000} \times Hrs_h \times (1 - HVAC_e)$$

$$\Delta kWh_c = \frac{(W_b - W_q)}{1,000} \times Hrs_c \times (1 + HVAC_e)$$

If motor wattage is unknown, estimate as:

$$W = \frac{0.746 \times HP}{Eff_{motor}}$$

Annual Fuel Savings

$$\Delta Therms = \frac{W_b \times ESF_h}{1,000} \times LF \times Hrs_h \times HVAC_{ff}$$

Peak Demand Savings

$$\Delta kW_{Peak} = \frac{(W_b \times ESF_c)}{1,000} \times LF \times (1 + HVAC_d) \times CF$$

Peak Daily Fuel Savings:

$$\Delta Therms_{Peak} = \Delta Therms \times PDF$$

Lifetime Energy Savings Algorithms:

Lifetime Electric Energy Savings

$$\Delta kWh_{Life} = \Delta kWh \times EUL$$

Lifetime Fuel Savings

$$\Delta Therms_{Life} = \Delta Therms \times EUL$$

Calculation Parameters

Table 3-165 Calculation Parameters

Variable	Description	Value	Units	Ref
ΔkWh	Annual electric energy savings	Calculated	kWh/yr	
ΔkWh _h	Annual electric heating savings	Calculated	kWh/yr	
ΔkWh _c	Annual electric cooling savings	Calculated	kWh/yr	
ΔkW _{Peak}	Peak Demand Savings	Calculated	kW	
W _b	Wattage of baseline motor	Site-specific, if unknown calculate from HP	Watts	
W _q	Wattage of efficient motor	Site-specific	Watts	

Variable	Description	Value	Units	Ref
Eff _{motor}	Motor efficiency	Site-specific, if unknown look up in Table 3-166	N/A	[10]
Hrs _h	Motor operating hours, heating	Site-specific, if unknown see Appendix D: HVAC Fan and Pump Operating Hours	Hrs	
Hrs _c	Motor operating hours, cooling	Site-specific, if unknown see Appendix D: HVAC Fan and Pump Operating Hours	Hrs	
ESF _h	Energy savings factor, heating	0.23	N/A	[9]
ESF _c	Energy savings factor, cooling	0.38		[9]
LF	Motor load factor	0.9	N/A	[9]
HVAC _e	HVAC interactivity factor, electric	See Appendix F: HVAC Interactivity Factors	N/A	
HVAC _d	HVAC interactivity factor, demand	See Appendix F: HVAC Interactivity Factors	N/A	
HVAC _{ff}	HVAC interactivity factor, fossil fuel	See Appendix F: HVAC Interactivity Factors	N/A	
CF	Coincidence factor	Look up in Table 3-167	N/A	
PDF	Gas peak demand factor	Look up in Table 3-167	N/A	
0.746	Conversion factor	0.746	kWh/HP	
1,000	Conversion factor	1,000	Watts/kW	
100	Conversion factor	100	kBtu/Therms	
EUL	Effective useful life	See Measure Life Section	Years	

Table 3-166 Default Motor Efficiency by Motor Type

Motor Type	Assumed Efficiency
Shaded Pole (SP)	0.40
Permanent Split Capacitor (PSC)	0.50
ECM	0.70

Peak Factors

Table 3-167 Peak Factors

Peak Factor	Value	Ref
Electric coincidence factor (CF)	0.8	[8]
Natural gas peak day factor (PDF)	See Appendix G: Natural Gas Peak Day Factors	

Measure Life

The remaining useful life (RUL) for retrofit projects is assumed to equal to the smaller of the motor EUL or the RUL of the host equipment. Default RUL of the host equipment is 1/3 of the EUL.

References

- [7] Federal standards: U.S. Department of Energy, *Federal Register*. 164th ed. Vol. 79, July 3, 2014.
<https://www.govinfo.gov/content/pkg/FR-2014-07-03/pdf/FR-2014-07-03.pdf>
- [8] New York Standard Approach for Estimating Energy Savings from Energy Efficiency Programs – Residential Multifamily, and Commercial/Industrial Measures. Version 6. April 16, 2018.
- [9] US DOE, *Evaluation of Retrofit Variable-Speed Furnace Fan Motors*, January 2014.
<https://www.nrel.gov/docs/fy14osti/60760.pdf>
- [10] DOE Building Technologies Office. Energy Savings Potential and Opportunities for High-Efficiency Electric Motors in Residential and Commercial Equipment.
<https://www.energy.gov/sites/prod/files/2014/02/f8/Motor%20Energy%20Savings%20Potential%20Report%202013-12-4.pdf>. Accessed December 2022.

3.5.14 ECONOMIZER CONTROLS

Market	Commercial/Multifamily
Baseline Condition	NC/RF/DI
Baseline	Existing/Dual
End Use Subcategory	Control
Measure Last Reviewed	December 2022

Description

This measure involves the installation of a dual enthalpy economizer to provide free cooling during the appropriate ambient conditions. Enthalpy refers to the total heat content of the air. A dual enthalpy economizer uses two sensors — one measuring return air enthalpy and one measuring outdoor air enthalpy. Dampers are modulated for optimum and lowest enthalpy to be used for cooling. Retrofit installations are only eligible for savings if the existing HVAC system does not have a functioning economizer.

New construction installations are only eligible for savings when economizers are not already required by the IECC 2021 Energy Code, Section C403.5.

Baseline Case

The baseline condition is the site-specific HVAC unit with fixed outside air (no economizer). If the actual HVAC efficiency is unknown, use the code-compliance efficiency for the unit type, size and age:

- New Construction: Unit compliant with ASHRAE Std. 90.1 – 2019 and IECC 2021.
- Retrofit and DI: Existing unit efficiency. If unknown, use code efficiency based on unit type, size and age.

Efficient Case

The efficiency condition is assumed to be an enthalpy economizer equipped with sensors that monitor the enthalpy of outside air and return air and modulate the outside air damper to optimize energy performance.

Annual Energy Savings Algorithm

Annual Electric Energy Savings

$$\Delta kWh = Tons \times \left(\frac{kWh}{ton} \right)_{Econ}$$

Annual Fuel Savings

$$\Delta Therms = N/A$$

Peak Demand Savings

$$\Delta kW_{Peak} = 0$$

Daily Peak Fuel Savings

$$\Delta Therms_{Peak} = N/A$$

Lifetime Energy Savings Algorithms:

Lifetime Electric Energy Savings

$$\Delta kWh_{Life} = \Delta kWh \times EUL$$

Lifetime Fuel Savings

$$\Delta Therms_{Life} = N/A$$

Dual:

Lifetime Electric Energy Savings

$$\Delta kWh_{Life} = \Delta kWh_{EREP} \times RUL + \Delta kWh_{NR} \times EUL$$

Lifetime Fuel Savings

$$\Delta Therms_{Life} = N/A$$

Calculation Parameters

Table 3-168 Calculation Parameters

Variable	Description	Value	Units	Ref
ΔkWh	Annual electric energy savings	Calculated	kWh/yr	
ΔkW_{Peak}	Peak Demand Savings	Calculated	kW	
ΔkWh_{Life}	Lifetime electric energy savings	Calculated	kWh	
Tons	Rated capacity of the cooling system retrofitted with an economizer	Site specific	Tons	
$(kWh/ton)_{Econ}$	Annual electric energy savings per ton of cooling	Look up in Table 3-169	Hrs/yr	[11]
CF	Electric coincidence factor	Look up in Table 3-170	N/A	
PDF	Gas peak demand factor	Look up in Table 3-170	N/A	
EUL	Effective useful life	See Measure Life Section	Years	
RUL	Remaining useful life of existing unit	See Measure Life Section	Years	

Table 3-169 Economizer savings kWh per Cooling Ton

Building Type	(kWh/ton) _{Econ}
Assembly	27
Big Box Retail	152
Fast Food	39
Full-Service Restaurant	31
Light Industrial	25
Primary School	42
Small Office	186
Small Retail	95
Religious	6
Warehouse	2
TOther	61

Peak Factors

Table 3-170 Peak Factors

Peak Factor	Value	Ref
Electric coincidence factor (CF)	0	
Natural gas peak day factor (PDF)	See Appendix G: Natural Gas Peak Day Factors	

Measure Life

The remaining useful life (RUL) for existing equipment is limited to 1/3 of the effective useful life (EUL) of the equipment.

Table 3-171 Measure Life

Equipment	EUL	RUL	Ref
Economizer Controls	10	3.33	[12]

References

- [11] *New York Standard Approach for Estimating Energy Savings from Energy Efficiency Programs – Version 10*. (New York State Joint Utilities, 2022), Appendix J Pg 1289-1290
[https://www3.dps.ny.gov/W/PSCWeb.nsf/96f0fec0b45a3c6485257688006a701a/72c23decff52920a85257f1100671bdd/\\$FILE/NYS%20TRM%20V10.pdf](https://www3.dps.ny.gov/W/PSCWeb.nsf/96f0fec0b45a3c6485257688006a701a/72c23decff52920a85257f1100671bdd/$FILE/NYS%20TRM%20V10.pdf)
- [12] California Public Utilities Commission EUL Table, version 027 (updated November 12, 2022). Accessed December 30, 2022. <https://www.caetrm.com/shared-data/value-table/EUL/>

3.5.15 GUEST ROOM EMS

Market	Commercial
Baseline Condition	RF
Baseline	Existing
End Use Subcategory	HVAC controls
Measure Last Reviewed	November 2022

Description

This measure covers the installation of an Energy Management System (EMS) in hotel/motel guest rooms or dormitories which automatically adjust the temperature setback during unoccupied periods. Network controlled systems must also include occupancy sensors in guest rooms. Room occupancy is typically detected by occupancy sensors, infrared sensors or key cards. During unoccupied periods the default setting for controlled units should differ by at least 5 degrees from the operating setpoint. Savings are based on the EMS system's ability to automatically adjust the temperature setpoint of the guest room for various occupancy modes reducing the consumption of electricity and/or gas by requiring less heating and/or cooling when a room or a facility is vacant or unoccupied. Measure applicable to Motel, Hotel and Dormitory building types only.

Baseline Case

Hotel/motel rooms or dormitories with manual heating/cooling temperature set-points and on/off controls.

Efficient Case

Hotel/motel guest room or dormitory with an EMS that automatically adjusts room temperature based on room occupancy during unoccupied periods

Annual Energy Savings Algorithm

Annual Electric Energy Savings

If electric heat:

$$\Delta kWh = \Delta kWh_{cool} + \Delta kWh_{heat}$$

If fuel heat:

$$\Delta kWh = kWh_{cool}$$

Where,

$$\Delta kWh_{cool} = \left(\frac{T_c \times (Hrs_{wk} + 7) + S_c \times (168 - (Hrs_{wk} + 7))}{168} - T_c \right) \times \frac{P_c \times Cap_c \times 12 \times EFLH_c}{EER}$$

$$\Delta kWh_{heat} = \left(T_h - \frac{T_h \times (Hrs_{wk} + 7) + S_h \times (168 - (Hrs_{wk} + 7))}{168} \right) \times \frac{P_h \times Cap_h \times EFLH_h}{COP \times 3,412}$$

Annual Fuel Savings

If fuel heat:

$$\Delta Therms = \left(T_h - \frac{T_h \times (Hrs_{wk} + 7) + S_h \times (168 - (Hrs_{wk} + 7))}{168} \right) \times \frac{P_h \times Cap_h \times EFLH_h}{AFUE \times 100,000}$$

Peak Demand Savings

$$\Delta kWh_{Peak} = \frac{\Delta kWh_{cool}}{EFLH_c} \times CF$$

Daily Peak Fuel Savings

$$\Delta Therms_{Peak} = \Delta Therms \times PDF$$

Lifetime Energy Savings Algorithms

Lifetime Electric Energy Savings

$$\Delta kWh_{Life} = \Delta kWh \times EUL$$

Lifetime Fuel Savings

$$\Delta Therms_{Life} = \Delta Therms \times EUL$$

Calculation Parameters

Table 3-172 Calculation Parameters

Variable	Description	Value	Units	Ref
ΔkWh	Annual electric energy savings	Calculated	kWh/yr	
ΔkWh _{cool}	Annual cooling electric energy savings	Calculated	kWh/yr	
ΔkWh _{heat}	Annual heating electric energy savings	Calculated	kWh/yr	
ΔTherms	Annual fuel savings	Calculated	Therms/yr	
ΔkW _{Peak}	Peak Demand Savings	Calculated	kW	
ΔTherms _{Peak}	Daily peak fuel savings	Calculated	Therms/day	
ΔkWh _{Life}	Lifetime electric energy savings	Calculated	kWh	
ΔTherms _{Life}	Lifetime fuel savings	Calculated	Therms	
Cap _h	Heating Capacity	Site-specific	Btu/hr	
Cap _c	Cooling capacity	Site-specific	Tons	

Variable	Description	Value	Units	Ref
T_h	Occupied heating setpoint temperature	Site-specific	°F	
T_c	Occupied cooling setpoint temperature	Site-specific	°F	
COP	Electric heating system coefficient of performance	Site-specific; use 1.0 for electric resistance heat	N/A	
AFUE	Heating Annual Fuel Utilization Efficiency	Site-specific. If unknown, use code compliant efficiency when the equipment was new	N/A	
EER	Cooling Energy Efficiency Ratio	Site-specific. If unknown, use code compliant efficiency when the equipment was new	Btu/hr-W	
Hrs _{swk}	Weekly occupied hours ¹⁰⁰	Site-specific; default to 84	Hr/wk	
S_h	Heating setback temperature	Site-specific; default to $T_h - 5$	°F	
S_c	Cooling setback temperature	Site-specific; default to $T_c + 5$	°F	
P_h	Heating savings fraction per degree of setback	0.03	N/A	[13]
P_c	Cooling savings fraction per degree of setback	0.06	N/A	[13]
EFLH _h	Heating Equivalent Full Load Hours. Measure applicable to Motel, Hotel and Dormitory building types only.	Look up in Appendix C:	Hr	[14]
EFLH _c	Cooling Equivalent Full Load Hours. Measure applicable to Motel, Hotel and Dormitory building types only.	Look up in Appendix C:	Hr	[14]
12	Conversion from tons to kBtu/hr	12	kBtu/h/ton	
168	Hours per week	168	Hr/wk	
7	Weekly hours for setback/setup adjustment based on 1 setback/setup per day, 7 days per week	7	Hr/wk	
3,412	Conversion from Btu to kWh	3,412	Btu/kWh	
100,000	Conversion from Btu to therms	100,000	Btu/therm	
CF	Coincidence factor	Look up in Table 3-173	kW/kWh	
PDF	Peak day factor	Look up in Table 3-173		
EUL	Effective useful life	See Measure Life Section	Years	

¹⁰⁰ Default value assumes operating hours is 12 hours a day, 7 days a week.

Peak Factors

Table 3-173 Peak Factors

Peak Factor	Value	Ref
Electric coincidence factor (CF)	0.65	
Natural gas peak day factor (PDF)	See Appendix G: Natural Gas Peak Day Factors	

Measure Life

The EUL for add-on equipment is limited to the remaining useful life (RUL) of the underlying system. If unknown, assume 1/3 of the EUL of the base HVAC equipment.

References

- [13] ENERGY STAR Programmable Thermostat Calculator. Savings assumptions per 2004 Industry Data.
- [14] Simulations of prototypical buildings from the NY TRM updated with NJ weather done by NJ Statewide Evaluator, May 2022.
- [15] Average of Massachusetts Utilities summer coincidence factors. Massachusetts Technical Reference Manual 2018, Hotel Occupancy Sensors, p. 496. <https://api-plus.anbetrack.com/etrm-gateway/etrm/api/v1/etrm/documents/5ee4885d6996f23f9d7df74e/view?authToken=b59b1ae4b9c838943ad9a016ecfb5fa2dc3491b1795547b0383adcb72316ae849bacc8d66cce22ab2e11950227aa7781219fb4b6425a3f033ac0a41355316faa4e1781cc0da1f#page=495>

3.5.16 SMART TSTATS

Market	Commercial
Baseline Condition	TOS/NC/RF/DI
Baseline	Code/ISP/Existing/Dual
End Use Subcategory	HVAC Control
Measure Last Reviewed	January 2023

Description

The smart thermostat measure involves the replacement of a manually operated or conventional programmable thermostat with a “smart” thermostat (defined below). This measure only applies to thermostats that control central A/C, heat pump, furnace, or rooftop units (RTUs) with capacity up to 300,000 Btu/h that serve normal conditioned spaces, not semi-conditioned spaces or spaces with large, frequently open doors (e.g., loading docks and car repair shops). Thermostats for larger systems should be treated as custom measures. This measure may be a time of sale, retrofit, direct install, or new construction measure.

Baseline Case

Retrofit and DI: As a retrofit measure, the baseline equipment is the in-situ manually operated or properly programmed thermostat that was replaced. If a manually operated non-programmable thermostat baseline is claimed, supporting photographic documentation should be collected.

Time of Sale or New Construction: The baseline condition is a programmable thermostat meeting minimum efficiency standards as presented in the 2021 International Energy Conservation Code (IECC 2021).

Efficient Case

The efficient condition is a smart thermostat that has earned ENERGY STAR certification[17] or has followed the ENERGY STAR product requirements[18].

Annual Energy Savings Algorithms

As smart thermostats are control technologies, when possible, heating and cooling savings should be calculated based on data from installed thermostats [19]. Otherwise, cooling savings should only be claimed for buildings with central air conditioning. Heating savings may be claimed for buildings with electric resistance, heat pump, or non-electric heating.

Annual Electric Energy Savings

$$\Delta kWh = \Delta kWh_c + \Delta kWh_h$$

Where,

$$\Delta kWh_c = CCAP \times EFLH_{cool} \times \frac{1}{SEER} \times SF_{elec,c}$$

$$\Delta kWh_h = HCAP_{elec} \times EFLH_{heat} \times \frac{1}{HSPF} \times SF_{elec,h}$$

Annual Fuel Savings

$$\Delta Therms = HCAP_{fuel} \times EFLH_{heat} \times \frac{1}{AFUE} \times SF_{fuel}$$

Peak Demand Savings¹⁰¹

$$\Delta kW_{Peak} = 0$$

Daily Peak Fuel Savings

$$\Delta Therms_{Peak} = \Delta Therms \times PDF$$

Lifetime Energy Savings Algorithms

Lifetime Electric Energy Savings

$$\Delta kWh_{Life} = \Delta kWh \times EUL$$

Lifetime Fuel Savings

$$\Delta Therms_{Life} = \Delta Therms \times EUL$$

Dual:

Lifetime Electric Energy Savings

$$\Delta kWh_{Life} = \Delta kWh_{EREP} \times RUL + \Delta kWh_{NR} \times EUL$$

Lifetime Fuel Savings

$$\Delta Therms_{Life} = \Delta Therms_{EREP} \times RUL + \Delta Therms_{NR} \times EUL$$

Calculation Parameters

Table 3-174 Calculation Parameters

Variable	Description	Value	Units	Ref
ΔkWh	Annual electric energy savings	Calculated	kWh/yr	

¹⁰¹ The smart thermostat measure as defined here (i.e., without a corresponding demand reduction program) is assumed to have no demand savings. Smart thermostats with a demand response program added on top may generate demand savings.

Variable	Description	Value	Units	Ref
Δ Therms	Annual fuel savings	Calculated	Therms/yr	
Δ kW _{Peak}	Peak Demand Savings	Calculated	kW	
Δ Therms _{Peak}	Daily peak fuel savings	Calculated	Therms/day	
Δ kWh _{Life}	Lifetime electric energy savings	Calculated	kWh	
Δ Therms _{Life}	Lifetime fuel savings	Calculated	Therms	
CCAP	Cooling capacity of existing AC unit	Site-specific	kBtu/hr	
SEER	SEER of controlled unit. For GSHPs, use EER.	Site-specific, if unknown look up in Appendix E: Code-Compliant Efficiencies		
HCAP _{fuel}	Heating capacity of existing furnace unit	Site-specific	MMBtu/hr	
AFUE	Annual Fuel Utilization Efficiency	Site-specific, if unknown look up in Appendix E: Code-Compliant Efficiencies	N/A	
HCAP _{elec}	Heating capacity of existing heat pump or electric resistance unit	Site-specific	kBtu/hr	
HSPF	Heating seasonal performance factor of controlled unit	Site-specific, if unknown look up in Appendix E: Code-Compliant Efficiencies. For electric resistance heat, use 3.412	Btu/W-h	
SF _{elec,c}	Electrical cooling percent savings from thermostat relative to baseline control	Look up in Table 3-175	%	[21][22]
SF _{elec,h}	Electrical heating percent savings from thermostat relative to baseline control	Look up in Table 3-175	%	[21][22]
SF _{fuel}	Heating fuel percent savings from thermostat relative to baseline control.	Look up in Table 3-175	%	[21][22]
EFLH _c	Full load hours for cooling equipment	Look up in Appendix C:	Hrs/yr	[16]
EFLH _h	Full load hours for heating equipment	Look up in Appendix C:	Hrs/yr	[16]
CF	Electric coincidence factor	Look up in Table 3-176	N/A	
PDF	Gas peak day factor	Look up in Table 3-176	N/A	
EUL	Effective useful life	See Measure Life Section	Years	
RUL	Remaining useful life of existing unit	See Measure Life Section	Years	

Table 3-175 Saving Factors for Smart Thermostats by Baseline Technology

Fuel and Function	Baseline Technology		
	Manual Thermostat	Programmable Thermostat	Unknown
Savings factor for electric cooling, $SF_{elec,c}$	5%	3%	3%
Savings factor for electric heating, $SF_{elec,h}$	4%	2%	2%
Savings factor for fuel heating, SF_{fuel}	5%	2%	2%

Peak Factors

Table 3-176 Peak Factors

Peak Factor	Value	Ref
Electric coincidence factor (CF)	N/A	
Natural gas peak day factor (PDF)	See Appendix G: Natural Gas Peak Day Factors	

Measure Life

In a retrofit scenario, this measure is being applied to existing operational equipment. Hence, the effective useful life (EUL) is the smaller of the host equipment remaining life or the full measure life of upgrade which is 5 years [23].

In a time of sale/new construction scenario, the effective useful life (EUL) IS 7.5 years [20].

References

- [16] Simulations of prototypical buildings from NY TRM updated with NJ weather done by NJ Statewide Evaluator, May 2022.
- [17] ENERGY STAR’s qualified products list for smart thermostats: <https://data.energystar.gov/dataset/ENERGY-STAR-Certified-Connected-Thermostats/7p2p-wkbf>
- [18] ENERGY STAR Smart Thermostat Specification, from which most requirements based: <https://www.energystar.gov/sites/default/files/ENERGY%20STAR%20Program%20Requirements%20for%20Connected%20Thermostats%20Version%201.0.pdf>
- [19] NEEP has developed a Guidance Document detailing methodology to claim savings from smart thermostats, available here: <https://neep.org/sites/default/files/resources/ClaimingSavingsfromSmartThermostatsGuidanceDocumentFinal.pdf>. This guidance uses the metric developed for the ENERGY STAR certification to develop geographically and temporally specific savings averages for program claims. These calculated savings numbers are expected to be more accurate and potentially yield higher level of savings than the estimates provided in the TRM.
- [20] Based on professional judgment of TRM technical team. EULs observed for residential applications include: 11 years in AR TRM and 10 years in IL TRM, both of which are based on programmable thermostat EULs. CA workpapers conclude 3-year EUL using persistence modeling. RTF concludes a 5-year EUL based on CA workpapers and concerns that there is little basis for assuming long-time persistence of savings, considering past

challenges with manual overrides and “know-how” needed to use wifi-connected devices, including communicating hardware and software downloading. For discussion, see Northwest Regional Technical Forum April 2017. <https://nwcouncil.box.com/v/ResConnectedTstatsv1-2>

[21] The savings percentages claimed for manual thermostats include the savings associated with upgrading from manual thermostats to programmable thermostats, which a 2015 MEMD study reported as about 3% savings for gas customers and 2% savings for electric customers.

http://www.michigan.gov/documents/mpsc/CI_Programmable_TStats_MEMD_6_15_15_491808_7.pdf

[22] Relative to a programmable thermostat, smart thermostats have savings opportunities available from a “smart recovery” function, which enables users to set the time they would like the building to reach a temperature as opposed to setting a time that the unit should start operating. Savings are also available from improved error detection and from locking out building occupants’ ability to override programmed schedules. Individual case studies have demonstrated savings in a variety of small commercial applications, but large-scale evaluations of smart thermostat savings have so far been limited to thermostats installed in residential applications. CLEAResult’s “Guide to Smart Thermostats” reports the ranges of savings measured in recent *residential* evaluations, relative to a baseline that blended programmable and manual thermostats: 10–13% for gas savings; 14–18% for electric cooling savings; and 6–13% for electric heating savings.

<https://www.clearesult.com/insights/whitepapers/guide-to-smart-thermostats/>

[23] California Public Utilities Commission Database for Energy Efficient Resources (DEER) EUL Support Table for 2020, <http://www.deeresources.com/files/DEER2020/download/SupportTable-EUL2020.xlsx>

3.5.17 MAINTENANCE

Market	Commercial/Multifamily
Baseline Condition	RF/DI
Baseline	Existing/Dual
End Use Subcategory	Maintenance
Measure Last Reviewed	December 2022

Description

This section provides energy savings algorithms for existing HVAC tune ups in commercial applications. Efficiency of various HVAC Units degrades with age and a “tune-up” or preventative maintenance can help restore some of the lost efficiency.

For gas applications, a tune-up of non-residential fossil space heating boilers or furnaces involves cleaning and inspection, adjusting air flow, reduce stack temperatures (for boilers), and adjust burner input among other steps.

Electric Units such as Central A/C and heat pumps also benefit greatly from tune ups. A tune up typically includes air filter replacement, cleaning of coils and fans, repair of case insulation, refrigerant charge adjustments, and air flow adjustments. This measure only applies to central AC Systems or heat pumps of 20 tons (65,000 BTU/h) or less.

Baseline Case

Gas: Commercial fossil space heating boiler or furnace that has not received a tune-up in 3 years or more.

Electric: An existing pre tune-up central A/C or heat pump that has not received a tune-up in 3 years or more.

Efficient Case

Gas: Commercial space heating boiler or furnace that has undergone a tune-up in accordance with the program requirements.

Electric: Central A/C System or heat pump after receiving tune up.

Annual Energy Savings Algorithm

Annual Electric Energy Savings

$$\Delta kWh = \Delta kWh_{Cool} + \Delta kWh_{Heat}$$

Where,

$$\Delta kWh_{Cool} = Cap_c \times EFLH_c \times \frac{1}{SEER_b} \times F_{improv}$$

$$\Delta kWh_{Heat} = Cap_h \times EFLH_h \times \frac{1}{HSPF_b} \times F_{improv}$$

$$F_{improv} = \frac{Eff_{improv,q} - Eff_{improv,b}}{Eff_{improv,q}}$$

Annual Fuel Savings

For boilers,

$$\Delta Therms = \frac{Cap_{in}}{100} \times \left(1 - \frac{Eff_{c,b}}{Eff_{c,q}}\right) \times EFLH_h$$

For furnaces,

$$\Delta Therms = \frac{F_{furnace} \times Cap_{in} \times EFLH_h}{100}$$

Where,

$$F_{furnace} = \frac{Eff_{f,b} + \Delta Eff_{f,q}}{Eff_{f,b}} - 1$$

Peak Demand Savings

$$\Delta kW_{Peak} = \frac{1}{EER_b} \times F_{improv} \times CF \times Cap_{in}$$

Daily Peak Fuel Savings

$$\Delta Therms_{Peak} = \Delta Therms \times PDF$$

Lifetime Energy Savings Algorithms:

Lifetime Electric Energy Savings

$$\Delta kWh_{Life} = \Delta kWh \times EUL$$

Lifetime Fuel Savings

$$\Delta Therms_{Life} = \Delta Therms \times EUL$$

Dual:

Lifetime Electric Energy Savings

$$\Delta kWh_{Life} = \Delta kWh_{EREP} \times RUL + \Delta kWh_{NR} \times EUL$$

Lifetime Fuel Savings

$$\Delta Therms_{Life} = \Delta Therms_{EREP} \times RUL + \Delta Therms_{NR} \times EUL$$

Calculation Parameters

Table 3-177 Calculation Parameters

Variable	Description	Value	Units	Ref
ΔkWh	Annual electric energy savings	Calculated	kWh/yr	
ΔkWh_{cool}	Annual cooling energy savings	Calculated	kWh/yr	
ΔkWh_{heat}	Annual heating energy savings	Calculated	kWh/yr	
$\Delta Therms$	Annual fuel savings	Calculated	Therms/yr	
ΔkW_{Peak}	Peak Demand Savings	Calculated	kW	
$\Delta Therms_{Peak}$	Daily peak fuel savings	Calculated	Therms/day	
ΔkWh_{Life}	Lifetime electric energy savings	Calculated	kWh	
$\Delta Therms_{Life}$	Lifetime fuel savings	Calculated	Therms	
F_{improv}	Percent improvement in EER/HSPF ¹⁰²	Calculated; if EER unknown look up in Table 3-178 ¹⁰³	N/A	[24][28]
$Eff_{improv,b}$	EER/EER2 of existing AC Unit or HSPF of existing Heat pumps	Site-specific	EER: BTU/watts HSPF: BTU/watt-hr	
$Eff_{improv,q}$	EER/EER2 of efficient AC Unit or HSPF of efficient Heat pumps	Site-specific	EER: BTU/watts HSPF: BTU/watt-hr	
EER_b	EER or EER2 of existing AC Unit	Site-specific	BTU/watts	
Cap_c	Cooling Capacity of existing AC Unit	Site-specific	kBTU/hr	
Cap_h	Heating Capacity of existing Heat Pumps	Site-specific	kBTU/hr	
Cap_{in}	Fuel input rating per boiler/furnace	Site-specific	kBTU/hr	
$Eff_{c,b}$	Baseline combustion efficiency as determined via flue gas analysis	Site-specific	N/A	
$Eff_{c,q}$	Post-implementation boiler combustion efficiency as determined via flue gas analysis	Site-specific	N/A	
$Eff_{f,b}$	Actual combustion efficiency of the furnace before tune-up, based on flue gas analysis	Site-specific	N/A	

¹⁰² For heat pumps: HSPF = COP x 3.413, where COP is coefficient of performance

¹⁰³ IL TRM derives savings estimates by applying the findings from DNV-GL "Impact Evaluation of 2013-2014 HVAC3 Commercial Quality Maintenance Programs", April 2016, to simulate the inefficient condition within select eQuest models and across climate zones. The percent savings were consistent enough across building types and climate zones that it was determined appropriate to apply a single set of assumptions for all. See 'eQuest C&I Tune up Analysis.xlsx' for more information.

Variable	Description	Value	Units	Ref
$Eff_{f,q}$	Post-implementation furnace combustion efficiency as determined via flue gas analysis	Site-specific	N/A	
$EFLH_c$	Equivalent Full Load Hours of operation for the average unit during the cooling season	See Appendix C:	Hours	[25]
$EFLH_h$	Equivalent Full Load Hours of operation for the average unit during the heating season	See Appendix C:	Hours	[25]
$SEER_b$	SEER or SEER2 of actual unit, before the tune-up	Site-specific, if unknown look up in Appendix E: Code-Compliant Efficiencies	Btu/W-h	
100	Conversion from kBtu to therms	100	kBtu/Therms	
$F_{furnace}$	Energy Savings Factor furnace	For Large Commercial - Calculated; For Small Commercial (<225 MBH) = 0.05	N/A	[26]
CF	Electric coincidence factor (CF)	Look up in Table 3-179	N/A	[28]
PDF	Gas peak demand factor	Look up in Table 3-179	N/A	
EUL	Effective useful life	See Measure Life Section	Years	

Table 3-178 Percent Improvement in EER (F_{improv})

Maintenance or Tune-Up Component	% Savings
Condenser Cleaning	6.10
Evaporator Cleaning	0.22
Refrigeration Charge Offset ≤20%	0.68
Refrigeration Charge Offset >20%	8.44

Peak Factors

Table 3-179 Peak Factors

Peak Factor	Value	Ref
Electric coincidence factor (CF)	0.478	[28]
Natural gas peak day factor (PDF)	See Appendix G: Natural Gas Peak Day Factors	

Measure Life

Measure Life for HVAC tune-up /maintenance measures is 3 yrs [27].

References

- [24] Energy Center of Wisconsin, *Central Air Conditioning in Wisconsin, A Compilation of Recent Field Research* (May 2008)
- [25] Simulations of prototype buildings from NY TRM updated with NJ weather done by NJ Statewide Evaluator, May 2022
- [26] Washington State University Energy Program, *Building Tune-Up and Operations Program Evaluation* (March 2007), Pg 5
- [27] DEER 2014 EUL http://www.deeresources.com/files/DEER2013codeUpdate/download/DEER2014-EUL-table-update_2014-02-05.xlsx
- [28] *2022 Illinois Statewide Technical Reference Manual for Energy Efficiency Version 10.0 Volume 2: Commercial and Industrial Measures* (2022), Pg 221-223 https://www.ilsag.info/wp-content/uploads/IL-TRM_Effective_010122_v10.0_Vol_2_C_and_I_09242021.pdf

3.5.18 ADVANCED ROOFTOP CONTROLS

Market	Commercial/Multifamily
Measure Condition	RF/DI
Baseline	Existing/Dual
End Use Subcategory	Controls
Measure Last Reviewed	November 2022

Description

This measure covers the installation of advanced rooftop unit control (ARC) on a constant volume rooftop HVAC unit with a single-speed supply fan. This involves the following 3 components, adding demand-controlled ventilation (DCV), Dual enthalpy economizers, and a supply fan with a variable frequency drive (VFD). DCV systems monitor the CO₂ levels and accordingly vary the supply outdoor air as needed, resulting in the reduction of heating and cooling loads. Dual enthalpy economizers reduce cooling loads by supplying outside air to the space when the outside air is deemed suitable for cooling. Multi/variable-speed fan motors reduce the fan speed for first stage cooling and ventilation.

Saving factors were calculated based on IL TRM values for Chicago, adjusted by ratio of Degree Days for each listed NJ Climate Zone and Chicago, based on TMY 3 Data using base 65 F balance point. See the 'Demand Controlled Ventilation' Section of the Illinois Statewide Technical Reference Manual V11 for further explanation [31].

It is important to note that only those components that are not required by code are eligible for savings.

Baseline Case

Constant volume rooftop HVAC unit with a single-speed supply fan and no occupancy-based ventilation or functioning airside economizer

Efficient Case

Rooftop HVAC Unit with an advanced rooftop unit controller added providing DCV, VFD fan speed controls, and dual enthalpy air-side economizer control

Annual Energy Savings Algorithm

Annual Electric Energy Savings

$$\Delta kWh = \Delta kWh_{fan} + \Delta kWh_{DCV} + \Delta kWh_{Econ}$$

Where

$$\Delta kWh_{fan} = hp \times ESF_{fan} \times hrs$$

$$\Delta kWh_{DCV} = \frac{A}{1,000} \times SF_{ElecCool} + \frac{A}{1,000} \times SF_{ElecHeat} \times F_{ElecHeat}$$

$$\Delta kWh_{Econ} = tons \times SF_{Econ}$$

Annual Fuel Savings

$$\Delta Therms = \frac{A}{1,000} \times SF_{fuel} \times F_{FuelHeat}$$

Peak Demand Savings

$$\Delta kW_{Peak} = hp \times ESF_{fan} \times CF$$

Daily Peak Fuel Savings

$$\Delta Therms_{Peak} = \Delta Therm \times PDF$$

Lifetime Energy Savings Algorithms

Lifetime Electric Energy Savings

$$\Delta kWh_{Life} = \Delta kWh \times EUL$$

Lifetime Fuel Savings

$$\Delta Therms_{Life} = \Delta Therms \times EUL$$

Dual:

Lifetime Electric Energy Savings

$$\Delta kWh_{Life} = \Delta kWh_{EREP} \times RUL + \Delta kWh_{NR} \times EUL$$

Lifetime Fuel Savings

$$\Delta Therms_{Life} = \Delta Therms_{EREP} \times RUL + \Delta Therms_{NR} \times EUL$$

Calculation Parameters

Table 3-180 Calculation Parameters

Variable	Description	Value	Units	Ref
ΔkWh	Annual electric energy savings	Calculated	kWh/yr	
$\Delta Therms$	Annual fuel savings	Calculated	Therms/yr	
ΔkW_{Peak}	Peak Demand Savings	Calculated	kW	
ΔkWh_{life}	Lifetime electric energy savings	Calculated	kWh	
$\Delta Therms_{life}$	Lifetime fuel savings	Calculated	Therms	
$\Delta Therms_{Peak}$	Daily peak fuel savings	Calculated	Therms/day	

Variable	Description	Value	Units	Ref
ΔkWh_{fan}	Annual electricity energy savings resulting from supply fan control	Calculated	kWh/yr	
ΔkWh_{DCV}	Annual electricity energy savings resulting from DCV	Calculated	kWh/yr	
ΔkWh_{Econ}	Annual electricity energy savings resulting from economizer	Calculated	kWh/yr	
hp	Horsepower of RTU supply fan	Site-specific	hp	
ESF_{fan}	Energy savings factor for supply fan control ¹⁰⁴	0.580	kWh/hp/hr	[29]
hrs	Annual operating hours of RTU supply fan	Site-specific if unknown use default values in Table 3-181	Hrs/yr	[30]
A	Total area square footage of the conditioned space impacted by the measure	Site-specific	Ft ²	
$SF_{ElecCool}$	DCV energy savings factor for cooling	Look up in Table 3-182	Kwh/1,000 ft ²	[31]
$SF_{ElecHeat}$	DCV energy savings factor for electric heating	Look up in Table 3-183, Table 3-184	Kwh/1,000 ft ²	[31]
$F_{elecHeat}$	Electric heating factor, used to account for the presence or absence of an electric heating system	1 (if electric heat) 0 (otherwise)	N/A	
tons	Tons of air conditioning supplied by RTU, based on nameplate data	Site-specific	tons	
SF_{econ}	Annual electric energy savings per ton of cooling resulting from economizer	Look up in Table 3-186	kWh/ton	[32]
SF_{Fuel}	DCV fuel savings factor for heating	Look up in Table 3-185	therms/1,000 ft ²	[31]
$F_{FuelHeat}$	Fuel heating factor, used to account for the presence or absence of a fossil fuel heating system	1 (if fossil fuel heat) 0 (otherwise)	N/A	
CF	Electric coincidence factor	Look up in Table 3-187	N/A	[33]
PDF	Gas peak day factor	Look up in Table 3-187	N/A	
EUL	Effective useful life	See Measure Life Section	Years	

¹⁰⁴ Unweighted average of kWh/hp/hour fan savings across all test cases in Advanced Rooftop Control (ARC) Retrofit: Field-Test Results, PNNL22656, Table 10: TMY weather normalized annual savings for all units. Fan Energy Savings (kWh) is divided by RTU Fan Power (hp) and Annual RTU Running Time (hr) to determine Energy Savings Factor for supply fan controls (kWh/hp/hr)

Table 3-181 Hours of Use Based on Building Type

Building Type	Sector	Hours
Grocery	Large Commercial/Industrial & Small Commercial	7,134
Medical - Clinic	Large Commercial/Industrial & Small Commercial	3,909
Medical - Hospital	Large Commercial/Industrial & Small Commercial	8,760
Office	Large Commercial/Industrial	2,969
	Small Commercial	2,950
Other	Large Commercial/Industrial & Small Commercial	4,573
Retail	Large Commercial/Industrial	4,920
	Small Commercial	4,926
School	Large Commercial/Industrial & Small Commercial	2,575
Warehouse/ Industrial	Large Commercial/Industrial	4,116
Warehouse/ Industrial	Small Commercial	3,799
Multifamily – Common Areas ¹⁰⁵	Multifamily	5,950
Multifamily – In-Unit	Multifamily	679
Multifamily – Exterior	Multifamily	3,338

Table 3-182 Energy Savings Factor for Cooling Associated with DCV (kWh/1,000 SF)

Building Type	North	Coastal	Central	Pine Barrens	Southwest	Statewide Average
Office - Low-rise (1 to 3 Stories)	267	362	368	366	359	334
Office - Mid-rise (4 to 11 Stories)	211	286	291	289	283	264
Office - High-rise (12+ Stories)	250	340	345	344	337	314
Religious Building	720	978	994	989	970	903
Restaurant	471	640	650	647	634	590
Retail - Department Store	363	493	501	498	489	455
Retail - Strip Mall	251	341	347	345	338	315
Convenience Store	330	448	455	453	444	413
Elementary School	339	460	468	465	456	425
High School	332	450	457	455	446	415

105 NEEP Mid-Atlantic TRM V10, p. 44.

Building Type	North	Coastal	Central	Pine Barrens	Southwest	Statewide Average
College/ University	393	534	543	540	530	493
Healthcare Clinic	327	444	451	449	440	410
Lodging (Hotel/Motel)	378	513	521	518	508	473
Manufacturing	163	222	226	224	220	205
Special Assembly Auditorium	537	729	740	737	722	672
Other	356	483	491	488	479	446
Enclosed Parking Garage	854	1,160	1,179	1,173	1,150	1,070

Table 3-183 Electric Heating Savings with Heat Pump Associated with DCV (kWh/1,000 SF)

Building Type	North	Coastal	Central	Pine Barrens	Southwest
Office - Low-rise (1 to 3 Stories)	185	149	163	158	163
Office - Mid-rise (4 to 11 Stories)	125	100	110	106	109
Office - High-rise (12+ Stories)	167	135	147	143	147
Religious Building	1206	970	1062	1028	1057
Restaurant	870	700	767	742	763
Retail - Department Store	298	239	262	254	261
Retail - Strip Mall	194	156	171	166	171
Convenience Store	147	119	130	126	129
Elementary School	517	416	456	441	454
High School	505	406	445	430	443
College/ University	1007	811	888	859	884
Healthcare Clinic	358	288	316	305	314
Lodging (Hotel/Motel)	166	134	147	142	146
Manufacturing	103	83	91	88	90
Special Assembly Auditorium	1414	1138	1246	1207	1241
Other	484	389	426	413	424
Enclosed Parking Garage	185	149	163	158	163

Table 3-184 Electric Heating Savings with Electrical Resistance Associated with DCV (kWh/1,000 SF)

Building Type	North	Coastal	Central	Pine Barrens	Southwest
Office - Low-rise (1 to 3 Stories)	556	448	490	474	488
Office - Mid-rise (4 to 11 Stories)	374	301	329	319	328
Office - High-rise (12+ Stories)	501	403	441	427	439
Religious Building	3617	2910	3186	3085	3172
Restaurant	2610	2100	2300	2226	2289
Retail - Department Store	893	718	786	761	783
Retail - Strip Mall	584	470	515	498	512
Convenience Store	441	355	389	376	387
Elementary School	1551	1248	1367	1323	1360
High School	1513	1218	1333	1291	1327
College/ University	3022	2432	2662	2577	2650
Healthcare Clinic	1074	865	947	916	942
Lodging (Hotel/Motel)	498	401	439	425	437
Manufacturing	310	250	273	265	272
Special Assembly Auditorium	4242	3414	3738	3619	3721
Other	1452	1169	1280	1239	1274

Table 3-185 Fuel Heating Savings Associated with DCV (therm/1,000 SF)

Building Type	North	Coastal	Central	Pine Barrens	Southwest
Office - Low-rise (1 to 3 Stories)	24	19	21	20	21
Office - Mid-rise (4 to 11 Stories)	16	13	14	14	14
Office - High-rise (12+ Stories)	22	17	19	19	19
Religious Building	155	124	136	132	136
Restaurant	111	90	98	95	98
Retail - Department Store	38	31	33	32	33
Retail - Strip Mall	25	20	22	22	22
Convenience Store	19	15	17	16	17
Elementary School	66	53	58	56	58
High School	64	52	57	55	56
College/ University	129	104	114	110	113
Healthcare Clinic	46	37	41	39	40

Building Type	North	Coastal	Central	Pine Barrens	Southwest
Lodging (Hotel/Motel)	21	17	18	18	18
Manufacturing	14	11	12	12	12
Special Assembly Auditorium	181	146	159	154	159
Other	61	49	54	52	54

Table 3-186 Economizer Savings kWh Per Cooling Ton

Building Type	(kWh/ton) _{Econ}
Assembly	27
Big Box Retail	152
Fast Food	39
Full-Service Restaurant	31
Light Industrial	25
Primary School	42
Small Office	186
Small Retail	95
Religious	6
Warehouse	2
Other	61

Peak Factors

Table 3-187 Peak Factors

Peak Factor	Value	Ref
Electric coincidence factor (CF)	0.8	[33]
Natural gas peak day factor (PDF)	TBD	

Measure Life

The remaining useful life (RUL) for existing equipment is limited to 1/3 of the effective useful life (EUL) of the equipment.

Table 3-188 Measure Life

Equipment	EUL	RUL	Ref
Advanced Rooftop Controls	5	1.67	[34]

References

- [29] *Advanced Rooftop Control (ARC) Retrofit: Field-Test Results*. (US DOE 2013) Table 10, https://www.pnnl.gov/main/publications/external/technical_reports/PNNL-22656.pdf
- [30] Navigant, *EmPOWER Maryland DRAFT Final Impact Evaluation Deemed Savings (June 1, 2017 – May 31, 2018) Commercial & Industrial Prescriptive, Small Business, and Direct Install Programs*, (2018)
- [31] *2023 Illinois Statewide Technical Reference Manual for Energy Efficiency Version 11 Volume 2: Commercial and Industrial Measures* (September 2022), Pg 357, https://www.ilsag.info/wp-content/uploads/IL-TRM_Effective_010123_v11.0_Vol_2_C_and_I_092222_FINAL.pdf
- [32] *New York Standard Approach for Estimating Energy Savings from Energy Efficiency Programs – Version 10*. (New York State Joint Utilities, 2023), Appendix J Pg 1279-1280
[https://www3.dps.ny.gov/W/PSCWeb.nsf/96f0fec0b45a3c6485257688006a701a/72c23decff52920a85257f1100671bdd/\\$FILE/NYS%20TRM%20V10.pdf](https://www3.dps.ny.gov/W/PSCWeb.nsf/96f0fec0b45a3c6485257688006a701a/72c23decff52920a85257f1100671bdd/$FILE/NYS%20TRM%20V10.pdf)
- [33] *New York Standard Approach for Estimating Energy Savings from Energy Efficiency Programs – Version 10*. (New York State Joint Utilities, 2023), Pg 818
[https://www3.dps.ny.gov/W/PSCWeb.nsf/96f0fec0b45a3c6485257688006a701a/72c23decff52920a85257f1100671bdd/\\$FILE/NYS%20TRM%20V10.pdf](https://www3.dps.ny.gov/W/PSCWeb.nsf/96f0fec0b45a3c6485257688006a701a/72c23decff52920a85257f1100671bdd/$FILE/NYS%20TRM%20V10.pdf)
- [34] *New York Standard Approach for Estimating Energy Savings from Energy Efficiency Programs – Version 10*. (New York State Joint Utilities, 2023), Pg 1366
[https://www3.dps.ny.gov/W/PSCWeb.nsf/96f0fec0b45a3c6485257688006a701a/72c23decff52920a85257f1100671bdd/\\$FILE/NYS%20TRM%20V10.pdf](https://www3.dps.ny.gov/W/PSCWeb.nsf/96f0fec0b45a3c6485257688006a701a/72c23decff52920a85257f1100671bdd/$FILE/NYS%20TRM%20V10.pdf)

3.6 SHELL

3.6.1 HIGH-RISE MULTIFAMILY AIR SEALING

Market	High-rise Multifamily
Baseline Condition	RF
Baseline	Existing
End Use Subcategory	Shell
Measure Last Reviewed	January 2023

Description

This section provides energy savings algorithms for the sealing air leakage paths to reduce the natural air infiltration rate through the installation of products and repairs to the building envelope. It is assumed that air sealing is the first priority among candidate space conditioning measures. Expected percentage savings is based on previous experiences with measured savings from similar programs.

The method below only applies to high-rise multifamily applications where blower door testing is not conducted. Blower door tests shall be performed whenever possible. A blower door test is performed to measure the leakage rate by depressurizing the building to a standard pressure difference of 50 Pascals or 0.2 inches of water. The measured flowrate indicates the leakage rate, or infiltration and exfiltration rate, of the building shell.

Baseline Case

The baseline case is a building envelope with natural air infiltration through air leakage paths.

Efficient Case

The exterior envelope, as well as interior walls/partitions between conditioned and unconditioned spaces should be inspected and all gaps sealed. At a minimum, the following items shall be inspected, and sealing measures may be implemented based upon inspection results:

- Caulk and weather strip doors and windows that leak air
- Repair or replace doors leading from conditioned to unconditioned space
- Seal air leaks between unconditioned (including unconditioned basement and attics) and conditioned spaces to include, but not limited to, plumbing, ducting, electrical wiring, wall top plates, chimneys, flues, and dropped soffits
- Use foam sealant on larger gaps around windows, baseboards, and other places where air leakage, either infiltration or exfiltration may occur

Annual Energy Savings Algorithms

Annual Electric Energy Savings

$$\Delta kWh = \frac{SF}{1,000} \times \left(\frac{\Delta kWh}{1,000 ft^2} \right)$$

Annual Fuel Savings

$$\Delta Therms = \frac{SF}{1,000} \times \left(\frac{\Delta Therms}{1,000 ft^2} \right)$$

Peak Demand Savings

$$\Delta kW_{Peak} = \frac{SF}{1,000} \times \left(\frac{\Delta kW}{1,000 ft^2} \right) \times CF$$

Daily Peak Fuel Savings

$$\Delta Therms_{Peak} = \Delta Therms \times PDF$$

Lifetime Energy Savings Algorithms

Lifetime Electric Energy Savings

$$\Delta kWh_{Life} = \Delta kWh \times EUL$$

Lifetime Fuel Savings

$$\Delta Therms_{Life} = \Delta Therms \times EUL$$

Calculation Parameters

Table 3-189 Calculation Parameters

Variable	Description	Value	Units	Ref
ΔkWh	Annual electric energy savings	Calculated	kWh/yr	
$\Delta Therms$	Annual fuel savings	Calculated	Therms/yr	
ΔkW_{Peak}	Peak Demand Savings	Calculated	kW	
$\Delta Therms_{Peak}$	Daily peak fuel savings	Calculated	Therms/day	
ΔkWh_{Life}	Lifetime electric energy savings	Calculated	kWh	
$\Delta Therms_{Life}$	Lifetime fuel savings	Calculated	Therms	
SF	Home square feet of conditioned floor area affected by installation	Site-specific	ft ²	
$\frac{\Delta kWh}{1,000 ft^2}$	Annual electric energy savings per thousand square feet	Lookup Table 3-190	kWh/ft ²	[36]

Variable	Description	Value	Units	Ref
$\frac{\Delta kW}{1,000 ft^2}$	Peak coincident demand electric savings per thousand square feet	Lookup Table 3-190	kWh/ft ²	[36]
$\frac{\Delta Therms}{1,000 ft^2}$	Annual gas energy savings per thousand square feet	Lookup Table 3-190	Therms/ ft ²	[36]
1,000	Conversion Factor from square feet (SF) to 1,000 square feet (kSF)	1000	N?A	
CF	Coincidence factor	Lookup in Table 3-132	N/A	
PDF	Gas peak day factor	Lookup in Table 3-132	N/A	
EUL	Effective useful life	See Measure Life section	Years	

Table 3-190 Impact per thousand square feet¹⁰⁶

Vintage	$\frac{\Delta kWh}{1,000 ft^2}$	$\frac{\Delta kW}{1,000 ft^2}$	$\frac{\Delta Therms}{1,000 ft^2}$
Old	118	0.119	29
Average	56	0.098	17

Peak Factors

Table 3-191 Peak Factors

Peak Factor	Value	Ref
Coincidence factor	0.69	[37]
Natural gas peak day factor (PDF)	See Appendix G: Natural Gas Peak Day Factors	

Measure Life

The effective useful life (EUL) is 15 years [35].

References

- [35] GDS Associates, Inc. Measure Life Report, Residential and Commercial/Industrial Lighting and HVAC Measures. 2007.
https://library.cee1.org/sites/default/files/library/8842/CEE_Eval_MeasureLifeStudyLights&HVACGDS_1Jun2007.pdf

¹⁰⁶ The baseline infiltration rate for old building is 1.0 ACH and average building is 0.5 ACH. The energy savings are based on a 15% reduction.

- [36] New York State Joint Utilities, New York Standard Approach for Estimating Energy Savings from Energy Efficiency Programs, V10, January 2023.
- [37] Based on BG&E 'Development of Residential Load Profile for Central Air Conditioners and Heat Pumps' research, the Maryland Peak Definition coincidence factor is 0.69. This study is not publicly available, but is referenced by M. M. Straub, Using Available Information for Efficient Evaluation of Demand-Side Management Programs, Electricity Journal, September 2011 and supported by research conducted by Cadmus on behalf of the RM Management Committee.

3.7 LIGHTING

3.7.1 LIGHTING FIXTURES

Market	Commercial/Multifamily
Baseline Condition	TOS/NC/DI
Baseline	Code/Existing/Dual
End Use Subcategory	Lighting Fixtures
Measure Last Reviewed	November 2022

Description

This section provides energy savings algorithms for qualifying lighting improvements implemented in commercial and industrial settings. This measure includes both retrofit of existing lamps and new construction projects.

Replacement programs includes fixture replacements for existing commercial and industrial customers. It is targeted for facilities performing efficiency upgrades to their lighting systems. New fixtures and technologies available after publication will be periodically updated. Baselines will be established based on the guidelines noted below.

For new construction and entire facility rehabilitation projects, savings are calculated by comparing the lighting power density (LPD) of fixtures being installed to the baseline LPD, or “lighting power allowance,” from the building code. For the state of New Jersey, the applicable building code is IECC 2021 [39].

Baseline Case

New Construction Interior Lighting: Baseline lighting LPD based on the IECC 2021 Code [39] with adjustments for standard practice [7].

New Construction Exterior Lighting: Baseline lighting LPA based on the IECC 2021 Code [39] with adjustments for standard practice [7].

Replacement: Actual existing fixture/lamp wattage. If unknown, use wattage from National Grid Fixture Wattage Table, 2015 [38].

Mid-Stream Lighting: Lookup in Appendix J: Lighting Wattages

Efficient Case

New Construction Interior Lighting: LPD of qualified fixtures, equal to the sum of installed fixture wattage divided by floor area of the space where the fixtures are installed.

New Construction Exterior Lighting: LPA of qualified fixtures, equal to the sum of installed fixture wattage

Retrofit: Wattage of new fixture.

Annual Energy Savings Algorithm

Annual Electric Energy Savings

New Construction Interior Lighting:

$$\Delta kWh = \frac{LPD_b \times LPD_{AF} - LPD_q}{1,000} \times A \times Hrs \times (1 + HVAC_e)$$

New Construction Exterior Lighting:

$$\Delta kWh = \frac{(LPA_b \times LPA_{AF} - LPA_q)}{1,000} \times AL \times Hrs$$

Replacement/Midstream Interior Lighting:

$$\Delta kWh = \frac{Qty_b \times W_b - Qty_q \times W_q}{1,000} \times Hrs \times (1 + HVAC_e)$$

Replacement/Midstream Exterior Lighting:

$$\Delta kWh = \frac{Qty_b \times W_b - Qty_q \times W_q}{1,000} \times Hrs$$

Annual Fuel Savings

Replacement/Midstream Interior Lighting:

$$\Delta Therms = (Qty_b \times W_b - Qty_q \times W_q) \times Hrs \times HVAC_g \times 10$$

New Construction Interior Lighting:

$$\Delta Therms = \frac{LPD_b \times LPD_{AF} - LPD_q}{1,000} \times A \times Hrs \times HVAC_g \times 10$$

Note: No fuel impacts are claimed in exterior lighting installation.

Peak Demand Savings

Retrofit Interior Lighting:

$$\Delta kW_{Peak} = \frac{Qty_b \times W_b - Qty_q \times W_q}{1,000} \times CF \times (1 + HVAC_d)$$

Retrofit Exterior Lighting:

$$\Delta kW_{Peak} = \frac{Qty_b \times W_b - Qty_q \times W_q}{1,000} \times CF$$

New Construction Interior Lighting:

$$\Delta kW_{Peak} = \frac{LPD_b \times LPD_{AF} - LPD_q}{1,000} \times A \times CF \times (1 + HVAC_d) \times (1 + SVG_b)$$

New Construction Exterior Lighting

$$\Delta kW_{Peak} = \frac{(LPA_b \times LPA_{AF} - LPA_q)}{1,000} \times CF$$

Daily Peak Fuel Savings

$$\Delta Therms_{Peak} = \Delta Therms * PDF$$

Lifetime Energy Savings Algorithms

Lifetime Electric Energy Savings

$$\Delta kWh_{Life} = \Delta kWh \times EUL$$

Lifetime Fuel Savings

$$\Delta Therms_{Life} = \Delta Therms \times EUL$$

Dual:

Lifetime Electric Energy Savings

$$\Delta kWh_{Life} = \Delta kWh_{EREP} \times RUL + \Delta kWh_{NR} \times EUL$$

Lifetime Fuel Savings

$$\Delta Therms_{Life} = \Delta Therms_{EREP} \times RUL + \Delta Therms_{NR} \times EUL$$

Calculation Parameters

Table 3-192 Calculation Parameters

Variable	Description	Value	Units	Ref
ΔkWh	Annual electric energy savings	Calculated	kWh/yr	
$\Delta Therms$	Annual fuel savings	Calculated	Therms/yr	
ΔkW_{Peak}	Peak Demand Savings	Calculated	kW	
$\Delta Therms_{Peak}$	Daily peak fuel savings	Calculated	Therms/day	
Qty_b	Quantity of Replaced Fixtures	Site-specific	N/A	
Qty_q	Quantity of Energy Efficient Fixtures	Site-specific	N/A	
W_b	Wattage of Baseline Fixture	Site-specific, if unknown see Appendix J: Lighting Wattages	W	[38]

Variable	Description	Value	Units	Ref
W_q	Wattage of Energy Efficient Fixture	Site-specific	W	
LPD_q	Installed lighting power density	Site-specific	W/Sq Ft	
LPD_b	Baseline lighting power density	Site-specific, if unknown look up in Table 3-193, Table 3-194, Table 3-196	W/Sq Ft	
LPA_b	Baseline lighting power allowance	Site-specific, if unknown look up in Table 3-196	W/Sq Ft or W/Linear Ft	[39]
LPA_q	Installed lighting power allowance	Site-specific, if unknown look up in Table 3-196	W/Sq Ft or W/Linear Ft	[39]
AL	If LPA unit is W/Sq Ft: AL is Area If LPA Unit is W/linear ft: AL is linear ft	Site-specific	Sq Ft or Linear Ft	
A	Area in Square Feet	Site-Specific	Square Foot	
Hrs	Annual Hours of Operation	Site-specific, if unknown use Table 3-197	Hrs/yr	[30]
LPD_{AF} (interior)	Interior Lighting LPD adjustment factor (25% better)	0.75	N/A	[44]
LPA_{AF} (exterior)	Exterior Lighting LPA adjustment factor (35% better)	0.65	N/A	[44]
$HVAC_e$	HVAC Interactive Factor for Annual Energy Savings	Look up in Table 3-198	N/A	[58][60]
$HVAC_g$	HVAC Interactive Factor for Annual Fuel Savings	Look up in Table 1 -8	N/A	[61]
$HVAC_d$	HVAC Interactive Factor for Peak Demand Savings	Look up in Table 3-198	N/A	[58][60]
CF	Coincidence Factor	Look up in Table 3-197	N/A	[30]
SVG_b	Savings control factor	Look up in Table 3-200		[47]
PDF	Gas peak day factor	Look up in Table 3-201		
RUL	Remaining useful life of existing equipment	Site-specific, if unknown use EUL/3	Years	
EUL	Effective useful life of new measure	See	Years	
1,000	Conversion from watts to kW	1,000	W/kW	
10	Conversion from MMBtu to therms	10	Therms/MMBtu	

Table 3-193 Baseline Lighting Power Density (Building Area Method) – IECC 2021 Standard Section C405.3.2(1) [39]

Building Area Type	LPD (Watts/ft ²)	Building Area Type	LPD (Watts/ft ²)
Automotive facility	0.75	Multifamily	0.45
Convention center	0.64	Museum	0.55
Court house	0.79	Office	0.64
Dining: bar lounge/leisure	0.80	Parking garage	0.18
Dining: cafeteria/fast food	0.76	Penitentiary	0.69
Dining: family	0.71	Performing arts theatre	0.84
Dormitory	0.53	Police/fire station	0.66
Exercise center	0.72	Post office	0.65
Fire station	0.56	Religious building	0.67
Gymnasium	0.76	Retail	0.84
Health care clinic	0.81	School/university	0.72
Hospital	0.96	Sports arena	0.76
Hotel/motel	0.56	Town hall	0.69
Library	0.83	Transportation	0.50
Manufacturing facility	0.82	Warehouse	0.45
Motion picture theatre	0.44	Workshop	0.91

Table 3-194 Baseline Lighting Power Density (Space by Space Method) 2021 IECC section C405.3.2(2) [2]

Space Types	LPD (watts/ft ²)	Space Types	LPD (watts/ft ²)
Atrium		Laundry/washing area	0.53
<i>Less than 40 feet in height</i>	0.48	Library	
<i>Greater than 40 feet in height</i>	0.6	<i>In a reading area</i>	0.96
Audience seating area		<i>In the stacks</i>	1.18
<i>In an auditorium</i>	0.61	Loading dock, interior	0.88
<i>In a gymnasium</i>	0.23	Lobby	
<i>In a motion picture theater</i>	0.27	<i>For an elevator</i>	0.65
<i>In a penitentiary</i>	0.67	<i>In a facility for the visually impaired (and not used primarily by the staff)^b</i>	1.69
<i>In a performing arts theater</i>	1.16	<i>In a hotel</i>	0.51
<i>In a religious building</i>	0.72	<i>In a motion picture theater</i>	0.23
<i>In a sports arena</i>	0.33	<i>In a performing arts theater</i>	1.25
<i>Otherwise</i>	0.33	<i>Otherwise</i>	0.84
Automotive (see Vehicular maintenance area)		Locker room	0.52
Banking activity area	0.61	Lounge/breakroom	

Space Types	LPD (watts/ft ²)
Breakroom (See Lounge/breakroom)	
Classroom/lecture hall/training room	
<i>In a penitentiary</i>	0.89
<i>Otherwise</i>	0.71
Computer room, data center	0.94
Conference/meeting/multipurpose room	0.97
Convention Center—exhibit space	0.61
Copy/print room	0.31
Corridor	
<i>In a facility for the visually impaired (and not used primarily by the staff)^b</i>	0.71
<i>In a hospital</i>	0.71
<i>Otherwise</i>	0.41
Courtroom	1.2
Dining area	
<i>In bar/lounge or leisure dining</i>	0.86
<i>In cafeteria or fast food dining</i>	0.4
<i>In a facility for the visually impaired (and not used primarily by the staff)^b</i>	1.27
<i>In family dining</i>	0.6
<i>In a penitentiary</i>	0.42
<i>Otherwise</i>	0.43
Dormitory—living quarters^{c, d}	0.5
Electrical/mechanical room	0.43
Emergency vehicle garage	0.52
Facility for the visually impaired^b	
<i>In a chapel (and not used primarily by the staff)</i>	0.7
<i>In a recreation room (and not used primarily by the staff)</i>	1.77
Fire Station—sleeping quarters^c	0.23
Food preparation area	1.09
Guestroom^{c, d}	0.41
Gymnasium/fitness center	
<i>In an exercise area</i>	0.9
<i>In a playing area</i>	0.85
Healthcare facility	
<i>In an exam/treatment room</i>	1.4
<i>In an imaging room</i>	0.94
<i>In a medical supply room</i>	0.62

Space Types	LPD (watts/ft ²)
<i>In a healthcare facility</i>	0.42
<i>Otherwise</i>	0.59
Manufacturing facility	
<i>In a detailed manufacturing area</i>	0.8
<i>In an equipment room</i>	0.76
<i>In an extra-high-bay area (greater than 50 feet floor-to-ceiling height)</i>	1.42
<i>In a high-bay area (25–50 feet floor-to-ceiling height)</i>	1.24
<i>In a low-bay area (less than 25 feet floor-to-ceiling height)</i>	0.86
Museum	
<i>In a general exhibition area</i>	0.31
<i>In a restoration room</i>	1.1
Office	
<i>Enclosed</i>	0.74
<i>Open plan</i>	0.61
Parking area, interior	0.15
Pharmacy area	1.66
Performing arts theater—dressing room	0.41
Post office—sorting area	0.76
Religious buildings	
<i>In a fellowship hall</i>	0.54
<i>In a worship/pulpit/choir area</i>	0.85
Restroom	
<i>In a facility for the visually impaired (and not used primarily by the staff)^b</i>	1.26
<i>Otherwise</i>	0.63
Retail facilities	
<i>In a dressing/fitting room</i>	0.51
<i>In a mall concourse</i>	0.82
Sales area	1.05
Seating area, general	0.23
Stairwell	0.49
Sports arena—playing area	
<i>For a Class I facility^e</i>	2.94
<i>For a Class II facility^f</i>	2.01
<i>For a Class III facility^g</i>	1.3
<i>For a Class IV facility^h</i>	0.86
Storage room	0.38

Space Types	LPD (watts/ft ²)
<i>In a nursery</i>	0.92
<i>In a nurse's station</i>	1.17
<i>In an operating room</i>	2.26
<i>In a patient room^c</i>	0.68
<i>In a physical therapy room</i>	0.91
<i>In a recovery room</i>	1.25
Laboratory	
<i>In or as a classroom</i>	1.11
<i>Otherwise</i>	133

Space Types	LPD (watts/ft ²)
Transportation facility	
<i>At a terminal ticket counter</i>	0.51
<i>In a baggage/carousel area</i>	0.39
<i>In an airport concourse</i>	0.25
Vehicular maintenance area	0.6
Warehouse—storage area	
<i>For medium to bulky, palletized items</i>	0.33
<i>For smaller, hand-carried items</i>	0.69
Workshop	1.26

- a. In cases where both a common space type and a building area specific space type are listed, the building area specific space type shall apply.
- b. A 'Facility for the Visually Impaired' is a facility that is licensed or will be licensed by local or state authorities for senior long-term care, adult daycare, senior support or people with special visual needs.
- c. Where sleeping units are excluded from lighting power calculations by application of Section R404.1, neither the area of the sleeping units nor the wattage of lighting in the sleeping units is counted.
- d. Where dwelling units are excluded from lighting power calculations by application of Section R404.1, neither the area of the dwelling units nor the wattage of lighting in the dwelling units is counted.
- e. Class I facilities consist of professional facilities; and semiprofessional, collegiate, or club facilities with seating for 5,000 or more spectators.
- f. Class II facilities consist of collegiate and semiprofessional facilities with seating for fewer than 5,000 spectators; club facilities with seating for between 2,000 and 5,000 spectators; and amateur league and high school facilities with seating for more than 2,000 spectators.
- g. Class III facilities consist of club, amateur league and high school facilities with seating for 2,000 or fewer spectators.
- h. Class IV facilities consist of elementary school and recreational facilities; and amateur league and high school facilities without provision for spectators.

Table 3-195 Exterior Lighting Zones - 2021 IECC section C405.5.2 (1)

Lighting Zone	Description
1	Developed areas of national parks, state parks, forest land, and rural areas
2	Areas predominantly consisting of residential zoning, neighborhood business districts, light industrial with limited nighttime use, and residential mixed-use areas
3	All other areas not classified as Lighting Zone 1, 2, or 4
4	High-activity commercial districts in major metropolitan areas as designated by the local land use planning authority

Table 3-196 Exterior Lighting Power Allowances – 2021 IECC Standard Section C405.5.2(2) and Section C405.5.2(3)

Category	Space	Units	Zone 1	Zone 2	Zone 3	Zone 4	
Base Site Allowance		W	350	400	500	900	
Traversable Surfaces	Uncovered Parking Areas	Parking areas and drives	W/ft ²	0.03	0.04	0.06	0.08
	Building Grounds	Walkways and ramps less than 10 feet wide	W/Linear Foot	0.50	0.50	0.60	0.70
	Building Grounds	Walkways and ramps 10 feet wide or greater, plaza areas	W/ft ²	0.10	0.10	0.11	0.14
	Building Grounds	Dining areas	W/ft ²	0.65	0.65	0.75	0.95

Category	Space	Units	Zone 1	Zone 2	Zone 3	Zone 4
Building Grounds	Stairways	W/ft ²	0.60	0.70	0.70	0.70
Building Grounds	Pedestrian tunnels	W/ft ²	0.12	0.12	0.14	0.21
Building Grounds	Landscaping	W/ft ²	0.03	0.04	0.04	0.04
Building Entrances and Exits	Pedestrian and vehicular entrances and exits	W/Linear Foot of opening	14	14	21	21
Building Entrances and Exits	Entry canopies	W/ft ²	0.20	0.25	0.40	0.40
Building Entrances and Exits	Loading docks	W/ft ²	0.35	0.35	0.35	0.35
Sales Canopies	Canopies (free-standing and attached)	W/ft ²	0.40	0.40	0.6	0.7
Outdoor Sales	Open areas (including vehicle sales lots)	W/ft ²	0.20	0.20	0.35	0.50
Outdoor Sales	Street frontage for vehicle sales lots in addition to "Open Area" allowance	W/Linear Foot	-	7	7	21
Non-Tradable Surfaces	Building facades	W/ft ² of gross above-grade wall area	-	0.075	0.113	0.15
	Automated teller machines (ATMs) and night depositories	W per location	135 plus 45 per additional ATM	135 plus 45 per additional ATM	135 plus 45 per additional ATM	135 plus 45 per additional ATM
	Uncovered entrances and gatehouse inspection stations at guarded facilities	W/ft ²	0.5	0.5	0.5	0.5
	Uncovered loading areas for law enforcement, fire, ambulance, and other emergency vehicles	W/ft ²	0.35	0.35	0.35	0.35
	Drive-up windows and doors	W/drive-through	200	200	200	200
	Parking near 24-hour retail entrances	W/main entry	400	400	400	400

Table 3-197 Hours of Use and Coincidence Factor by Building Type

Building Type	Sector	CF	Hours
Grocery	Large Commercial/Industrial & Small Commercial	0.96	7,134
Medical - Clinic	Large Commercial/Industrial & Small Commercial	0.8	3,909
Medical - Hospital	Large Commercial/Industrial & Small Commercial	1	8,760 ¹⁰⁷
Office	Large Commercial/Industrial	0.7	2,969
	Small Commercial	0.67	2,950
Other	Large Commercial/Industrial & Small Commercial	0.66	4,573

¹⁰⁷ Assumes hospital operations are year round.

Building Type	Sector	CF	Hours
Retail	Large Commercial/Industrial	0.96	4,920
	Small Commercial	0.86	4,926
School	Large Commercial/Industrial & Small Commercial	0.50	2,575
Warehouse/ Industrial	Large Commercial/Industrial	0.7	4,116
	Small Commercial	0.68	3,799
Outside/Outdoor Area	All	0.11	3604
Parking Garage	All	0.98	8678
Multifamily – Common Areas ¹⁰⁸	Multifamily	0.86	5,950
Multifamily – In-Unit	Multifamily	0.59	679
Multifamily –Exterior	Multifamily	0.00	3,338
College/University - Cafeteria ¹⁰⁹	All	0.79	2,713
College/University – Classes ³	All	0.54	2,586
College/University - Dormitory ³	All	0.92	3,066
Religious Building ³	All	0.89	1,955
Nursing Home ³	All	0.92	5,840

Table 3-198 HVAC Interactive Effects¹¹⁰

Building Type	HVAC Interactive Factor for Peak Demand Savings (HVAC _d)		HVAC Interactive Factor for Annual Energy Savings (HVAC _e)			
	AC (Utility)	AC (PJM)	AC/NonElec	AC/ElecRes	Heat Pump	NoAC/ElecRes
Office	0.35	0.32	0.10	-0.15	-0.06	-0.25
Retail	0.27	0.26	0.06	-0.17	-0.05	-0.23
Education	0.44	0.44	0.10	-0.19	-0.04	-0.29
Warehouse	0.22	0.23	0.02	-0.25	-0.11	-0.27

¹⁰⁸ NEEP Mid-Atlantic TRM V9, p. 24.

¹⁰⁹ From NY TRM V10, Pg 862

¹¹⁰ These values only apply for conditioned spaces. For unconditioned spaces, the ininteractive factors are equal to zero.

Building Type	HVAC Interactive Factor for Peak Demand Savings (HVAC _d)		HVAC Interactive Factor for Annual Energy Savings (HVAC _e)			
	AC (Utility)	AC (PJM)	AC/NonElec	AC/ElecRes	Heat Pump	NoAC/ElecRes
Mid-Stream/Other ¹¹¹	0.34	0.32	0.08	-0.18	-0.07	-0.26

Table 3-199 Interactive Factor (HVAC_g) for Annual Fuel Savings

Project Type	Fuel Type	Impact (MMBtu/Δkwh)
Large Retrofit (> 200 kW)	Gas Heat	-0.0023
Large Retrofit (> 200 kW)	Oil Heat	-0.0046
Small Retrofit (≤ 200 kW)	Gas Heat	-0.01075
Small Retrofit (≤ 200 kW)	Oil Heat	-0.00120
Unknown	Unknown	-0.00096995 ¹¹²

Table 3-200 Baseline SVG Values

Building Type	SVGbase
Education	17%
Exterior	0%
Grocery	5%
Health	8%
Industrial/Manufacturing – 1 Shift	0%
Industrial/Manufacturing – 2 Shift	0%
Industrial/Manufacturing – 3 Shift	0%
Institutional/Public Service	12%
Lodging	15%
Miscellaneous/Other	6%
Office	15%
Parking Garage	0%
Restaurant	5%
Retail	5%
Warehouse	14%

¹¹¹ The 'Other' building type should be used when the building type is known but not explicitly listed above. A description of the actual building type should be recorded in the project documentation.

¹¹² Weighted average of small retrofit types

Custom	Based on Code
--------	---------------

Peak Factors

Table 3-201 Peak Factors

Peak Factor	Value	Ref
Electric coincidence factor (CF)	Look up in Table 3-197	[30]
Natural gas peak day factor (PDF)	See Appendix G: Natural Gas Peak Day Factors	

Measure Life

Table 3-202 Measure Life (EUL)

Equipment Type	Baseline Type = RF, DI	Baseline Type = NC	Ref
LED Fixture	5.4	Fixture rated life / operating hours (Table 1-6). Not to exceed 15 yr.	[45]
LED Fixture with Controls	6.6	Fixture rated life / operating hours (Table 1-6). Not to exceed 15 yr.	[45]
TLED	5.2	N/A	[45]
High Bay/Low Bay LED Fixture	6.6	Fixture rated life / operating hours (Table 1-6). Not to exceed 15 yr.	[45]
High Bay/Low Bay LED Fixture with Controls	7.6	Fixture rated life / operating hours (Table 1-6). Not to exceed 15 yr.	[45]
High Bay/Low Bay TLED	6.2	N/A	[45]
Exterior/Outdoor LED Fixture	6.6	Fixture rated life / operating hours (Table 1-6). Not to exceed 15 yr.	[45]
Exterior/Outdoor LED Fixture with Controls	7.6	Fixture rated life / operating hours (Table 1-6). Not to exceed 15 yr.	[45]
Exterior/Outdoor TLED	6.2	N/A	[45]
Screw-in LEDs	1	N/A	[46]

References

- [38] Review of Device Codes and Rated Lighting System Wattage Table Retrofit Program. 2015. National Grid. January 13, 2015. https://www.nationalgridus.com/non_html/2010_Retrofit_Lighting_DeviceCodes_RI.pdf
- [39] “2021 INTERNATIONAL ENERGY CONSERVATION CODE (IECC) | ICC DIGITAL CODES.” n.d. Codes.iccsafe.org. Accessed November 16, 2022. <https://codes.iccsafe.org/content/IECC2021P2/chapter-4-ce-commercial-energy-efficiency>.
- [40] Navigant, *EmPOWER Maryland DRAFT Final Impact Evaluation Deemed Savings (June 1, 2017 – May 31, 2018) Commercial & Industrial Prescriptive, Small Business, and Direct Install Programs*, (2018)

- [41] Navigant, *EmPOWER Maryland DRAFT Final Impact Evaluation Report Evaluation Year 4 (June 1, 2012 – May 31, 2013) Commercial & Industrial Prescriptive & Small Business Programs*, (2013)
- [42] DNV KEMA (2013). *Impact Evaluation of 2010 Prescriptive Lighting Installations. Prepared for Massachusetts Energy Efficiency Program Administrators and Massachusetts Energy Efficiency Advisory*
- [43] Northeast Energy Efficiency Partnerships & KEMA, *C&I Lighting Load Shape Project FINAL Report - Prepared for the Regional Evaluation, Measurement and Verification Forum*. (2011).
- [44] DNV, *New Jersey Commercial New Construction Industry Standard Practice Analysis. Prepared for Rutgers University and the NJ Board of Public Utilities*. (2022).
- [45] DNV, *New Jersey Non-Residential Lighting Market Characterization. Prepared for Rutgers University and the NJ Board of Public Utilities*. (2022).
- [46] Engineering judgement based on expected existing incandescent or halogen lamp remaining life. Once the existing lamp has burned out, replacement with an EISA-compliant lamp is assumed to be the only option.
- [47] *Technical Reference Manual Volume 3: Commercial and Industrial Measures* (August 2019) Pg 21
<https://www.puc.pa.gov/filing-resources/issues-laws-regulations/act-129/technical-reference-manual/>

3.7.2 LIGHTING CONTROLS

Market	Commercial
Baseline Condition	NC/RF/DI
Baseline	ISP/Existing/Dual
End Use Subcategory	Control
Measure Last Reviewed	January 2023

Description

Normal Lighting Controls

Normal lighting controls include occupancy sensors, daylight dimmer systems, and occupancy controlled hi-low controls for fluorescent, LED and HID fixtures.

Networked Lighting Controls

This measure defines the savings associated with installing a network controlled lighting system. The control system must include luminaire-level lighting control (LLLC) that can switch lights on and off based on occupancy and is capable of full-range dimming based on local light levels. Note: Because networked lighting controls are required to include occupancy sensors and daylight harvesting, savings from occupancy sensors and daylight dimming control cannot be claimed separately. Additional savings may be achieved at no additional hardware cost on a site-specific basis by implementing high-end trimming, personalized local controls, and customized scheduling with no need for additional equipment or software.

Bi-level Lighting Controls

This measure addresses bi-level occupancy control of lighting in stairwells, corridors, parking garages and parking lots via the installation of controls on existing fixtures or installation of luminaires with integrated bi-level occupancy control. Bi-level occupancy control allows for the continuous lighting of spaces at code-mandated minimum illumination levels when the space is unoccupied and at higher light levels when occupied. This measure is only applicable as a retrofit or replacement in existing buildings because multi-level switching at defined lighting power densities and percentages of full connected load is mandated in many space types by federal, state, local and municipal codes and standards. This measure is restricted to lighting in parking lots and in spaces that are required by fire and safety code to be illuminated continuously. The post-implementation case must comply with all provisions of applicable fire, safety and construction code.

Baseline Case

Retrofit (RF): The baseline condition is the existing lighting control system which includes uncontrolled (continuous) operation or manual on/off controls

New Construction (NC): The baseline condition a control system that meets ASHRAE 90.1-2019 or industry standard practice in new construction.

Efficient Case

Normal Lighting

Lighting controlled by occupancy sensors, daylight dimming systems.

Networked Lighting

The efficient condition is a network controlled lighting system.

Bi-level Lighting

The efficient condition is stairwells, corridors, parking garages and parking lots with bi-level occupancy control installed and meeting all provisions of applicable federal, state, local and municipal fire, safety and construction code and is compatible with the existing lighting fixture types.

Annual Energy Savings Algorithms

Annual Electric Energy Savings

Normal Lighting

$$\Delta kWh = kW_c \times Hrs \times SVG_{nl} \times (1 + HVAC_e)$$

Networked Lighting Occupancy Sensors

$$\Delta kWh = kW_c \times Hrs \times SVG_{os} \times ISR \times (1 + HVAC_e)$$

Networked Lighting Daylight Dimming Control

$$\Delta kWh = kW_c \times Hrs \times SVG_{dc} \times ISR \times (1 + HVAC_e)$$

Bi-level Lighting

$$\Delta kWh = \left[\frac{W_b}{1,000} - \left(\frac{W_q}{1,000} \times (1 - SVG_{bl}) \right) \right] \times Hrs$$

Where,

$$SVG_{bl} = F_{low} \times \left(1 - \frac{W_{low}}{W_q} \right)$$

Annual Fuel Savings

Normal Lighting

$$\Delta Therms = kW_c \times Hrs \times SVG_{nl} \times \frac{HVAC_g}{10}$$

Networked Lighting

$$\Delta Therms = \left(-\frac{\Delta kWh}{HVAC_g} \right) \times 0.00073$$

Bi-level Lighting

$$\Delta Therms = N/A$$

Peak Demand Savings

Normal Lighting

$$\Delta kW_{Peak} = kW_c \times SVG_{nl} \times CF \times (1 + HVAC_d)$$

Networked Lighting Occupancy Sensors

$$\Delta kW_{Peak} = kW_c \times SVG_{os} \times ISR \times (1 + HVAC_d) \times CF$$

Networked Lighting Daylight Dimming Control

$$\Delta kW_{Peak} = kW_c \times SVG_{dc} \times ISR \times (1 + HVAC_d) \times CF$$

Bi-level Lighting

$$\Delta kW_{Peak} = \left[\frac{W_b}{1,000} - \left(\frac{W_q}{1,000} \times (1 - SVG_{bl,demand}) \right) \right] \times CF$$

Where,

$$SVG_{bl,demand} = F_{low} \times \left(1 - \frac{W_{low}}{W_q} \right)$$

Daily Peak Fuel Savings

$$\Delta Therms_{Peak} = \Delta Therms \times PDF$$

Lifetime Energy Savings Algorithms

Lifetime Electric Energy Savings

$$\Delta kWh_{Life} = \Delta kWh \times EUL$$

Lifetime Fuel Savings

$$\Delta Therms_{Life} = \Delta Therms \times EUL$$

Dual:

Lifetime Electric Energy Savings

$$\Delta kWh_{Life} = \Delta kWh_{EREP} \times RUL + \Delta kWh_{NR} \times EUL$$

Lifetime Fuel Savings

$$\Delta Therms_{Life} = \Delta Therms_{EREP} \times RUL + \Delta Therms_{NR} \times EUL$$

Calculation Parameters

Table 3-203 Calculation Parameters

Variable	Description	Value	Units	Ref
ΔkWh	Annual electric energy savings	Calculated	kWh/yr	
$\Delta Therms$	Annual fuel savings	Calculated	Therms/yr	
ΔkW_{Peak}	Peak Demand Savings	Calculated	kW	
$\Delta Therms_{Peak}$	Daily peak fuel savings	Calculated	Therms/day	
ΔkWh_{Life}	Lifetime electric energy savings	Calculated	kWh	
$\Delta Therms_{Life}$	Lifetime fuel savings	Calculated	Therms	
ESF	Energy savings factor	Calculated	N/A	
SVG_{bl}	Percent of annual lighting energy saved by the bilevel lighting control	Calculated	N/A	
$SVG_{bl,demand}$	Percent of annual lighting demand energy saved by the bilevel lighting control	Calculated	N/A	
kW_c	Lighting load connected to control	Site-specific	kW	
W_b	Wattage of existing fixture	Site-specific	W	
W_q	Wattage of efficient fixture at full light output	Site-specific	W	
W_{low}	Wattage of the efficient fixture in low-power mode	Site-specific	Watts	
F_{low}	Percentage of annual operating hours that the fixture operated in low-power mode	Site-specific, if unknown lookup in Table 3-208	N/A	[51][52][53][54]
SVG_{nl}	Percent of annual lighting energy saved by the normal lighting control	Lookup in Table 3-204	N/A	[50]
SVG_{os}	Percent of annual lighting energy saved by the occupancy sensor control	Lookup in Table 3-204	N/A	[50]
SVG_{dc}	Percent of annual lighting energy saved by the daylight dimming control	Lookup in Table 3-204	N/A	[50]
$HVAC_d$	Secondary demand in reduced HVAC consumption resulting from decreased indoor lighting wattage	Lookup in Table 3-206	N/A	[48]
$HVAC_e$	Secondary energy savings in reduced HVAC consumption resulting from decreased indoor lighting wattage	Lookup in Table 3-206	N/A	[48]

Variable	Description	Value	Units	Ref
HVAC _g	Secondary energy savings in reduced HVAC consumption resulting from decreased indoor lighting wattage	Lookup in Table 3-207	MMBtu/kWh	[49]
Hrs	Annual hours of operation prior to installation of controls	Lookup in Table 3-205	Hours	
ISR	In-service rate	1	N/A	
1,000	Conversion factor	1,000	kW/W	
10	Conversion factor	10	Therms/MMBtu	
CF	Electric coincidence factor	Lookup in Table 3-209	N/A	[55]
PDF	Gas peak day factor	Lookup in Table 3-209	N/A	
EUL	Effective useful life	See Measure Life Section	Years	

Table 3-204 SVG

Lighting Control Type	SVG
Networked lighting controls (NLC)	0.49
Luminaire-level lighting controls (LLLC) – Networked & Commissioned	0.49
Integrated fixture with room-based controls	0.38 ¹¹³
Dual occupancy and daylight sensors	0.38
Combination of high-end trim and daylight dimming	0.35
Combination of high-end trim and occupancy sensors	0.33
Daylight dimming	0.28
Occupancy sensors	0.24
No lighting controls	0.00

Table 3-205 Building Type

Building Type	Hrs	CF
Grocery	7,134	0.96
Medical-Clinic	3,909	0.80

¹¹³ 38% is highest savings factor associated with a non-networked fixture with integrated controls. This was determined to be a reasonable assumption for a fixture with three integrated controls that is not networked or verified/commissioned.

Building Type	Hrs	CF
Medical-Hospital	7,760	0.80
Office-Large C&I	2,969	0.70
Office-Small C&I	2,950	0.67
Other	4,573	0.66
Retail-Large C&I	4,920	0.96
Retail-Small C&I	4,926	0.86
School	2,575	0.50
Warehouse/Industrial-Large C&I	4,116	0.70
Warehouse/Industrial-Small C&I	3,700	0.68
Unknown	2,575	0.50

Table 3-206 HVAC Interactive Effects for Annual Energy Savings

Building Type	HVAC Interactive Factor for Peak Demand Savings (HVAC _d)		HVAC Interactive Factor for Annual Energy Savings (HVAC _e)			
	AC (Utility)	AC (PJM)	AC/NonElec	AC/ElecRes	Heat Pump	No AC/ElecRes
Office	0.35	0.32	0.10	-0.15	-0.06	-0.25
Retail	0.27	0.26	0.06	-0.17	-0.05	-0.23
Education	0.44	0.44	0.10	-0.19	-0.04	-0.29
Warehouse	0.22	0.23	0.02	-0.25	-0.11	-0.27
Other ¹¹⁴	0.34	0.32	0.08	-0.18	-0.07	-0.26

Table 3-207 HVAC Interactive Factor for Annual Fuel Savings

Project Type	Fuel Type	HVAC _g
Large Retrofit (>200kW)	C&I Gas Heat	-0.00023
Large Retrofit (>200kW)	Oil	-0.00046
Small Retrofit (≤ 200kW)	Gas Heat	-0.001075
Small Retrofit (> 200kW)	Oil Heat	-0.000120

¹¹⁴ Per the NEEP Mid-Atlantic TRM, v7: "The 'Other' building type should be used when the building type is known but not explicitly listed above. A description of the actual building type should be recorded in the project documentation."

Table 3-208 Low-Power Mode Factor

Space Type	F _{low}
Stairwell	0.73
Corridor	0.75
Parking Garage	0.56
Parking Lot	0.45

Peak Factors**Table 3-209 Peak Factors**

Peak Factor	Value	Ref
Electric coincidence factor (CF)	Lookup in Table 3-205	[55]
Natural gas peak day factor (PDF)	See Appendix G: Natural Gas Peak Day Factors	

Measure Life

The remaining useful life (RUL) for existing equipment is limited to 1/3 of the effective useful life (EUL) of the equipment.

Table 3-210 Measure Life

Equipment	EUL	RUL	Ref
Lighting Controls	8	2.67	[56]

References

- [48] Average HVAC interactive effects by building type derived from the NEEP Mid-Atlantic TRM 2017, NEEP, *Mid-Atlantic Technical Reference Manual*, V10, Appendix E.
- [49] Massachusetts TRM, 2016-2018 Program Years, October 2015. Original source: DNV KEMA (2013). Impact Evaluation of 2010 Prescriptive Lighting Installations. Prepared for Massachusetts Energy Efficiency Program Administrators and Massachusetts Energy Efficiency Advisory Council
- [50] DNV. 2022. "X1931-4 ALC PSD Phase 2 Memo." Connecticut Energy Efficiency Board (EEB) and Evaluation Administrators.
- [51] California Energy Commission, Lighting Research Program, Project 5.1 Bi-level Stairwell Fixture Performance Final Report, October 2005 – Average of "Time Dimmed" across the four test sites during weekday operation (Table 2. Weekday daily average energy usage and savings, pg. 22).
- [52] CA State Partnership for Energy Efficiency Demonstrations, Interior Lighting Case Study: Adaptive Corridor Lighting, April 2014, pg. 2.
https://cltc.ucdavis.edu/sites/default/files/files/publication/CASE_STUDY_UCSF_Adaptive_Corridors_140602.pdf
- [53] California Energy Commission Public Interest Energy Research Program, Case Study: Bi-Level LED Parking Garage Luminaires – Average of unoccupied hours across the three test sites.
<https://cltc.ucdavis.edu/sites/default/files/files/publication/case-study-bi-level-led-garage-luminaires.pdf>

- [54] Pacific Gas & Electric, Application Assessment of Bi-Level LED Parking Lot Lighting, February 2009, pg. 1.
<https://www.osti.gov/biblio/1218189>
- [55] NEEP Mid-Atlantic TRM 2018, NEEP, Mid-Atlantic Technical Reference Manual, V8. May 2018, pp. 462-463.
- [56] California Public Utilities Commission EUL Table, version 027 (updated November 12, 2022). Accessed December 30, 2022. <https://www.caetrm.com/shared-data/value-table/EUL/>

3.7.3 DELAMPING

Market	Commerical
Baseline Condition	ERET/DI
Baseline	Existing/Dual
End Use Subcategory	Lighting
Measure Last Reviewed	January 2023

Description

This measure relates to the permanent removal of a lamp and the associated electrical sockets (or “tombstones”) from a fixture.

Baseline Case

The baseline conditions will vary dependent upon the characteristics of the existing fixture.

Efficient Case

The efficient condition will vary depending on the existing fixture and the number of lamps removed.

Annual Energy Savings Algorithms

Annual Electric Energy Savings

$$\Delta kWh = \frac{Watts_b - Watts_q}{1,000} \times Hrs \times (1 + HVAC_e)$$

Annual Fuel Savings

$$\Delta Therms = \frac{Watts_b - Watts_q}{1,000} \times Hrs \times HVAC_g$$

Peak Demand Savings

$$\Delta kW_{Peak} = \frac{Watts_b - Watts_q}{1,000} \times (1 + HVAC_e) \times CF$$

Daily Peak Fuel Savings

$$\Delta Therms_{Peak} = \Delta Therms \times PDF$$

Lifetime Energy Savings Algorithms

Lifetime Electric Energy Savings

$$\Delta kWh_{Life} = \Delta kWh \times EUL$$

Lifetime Fuel Savings

$$\Delta Therms_{Life} = \Delta Therms \times EUL$$

Dual:

Lifetime Electric Energy Savings

$$\Delta kWh_{Life} = \Delta kWh_{EREP} \times RUL + \Delta kWh_{NR} \times EUL$$

Lifetime Fuel Savings

$$\Delta Therms_{Life} = \Delta Therms_{EREP} \times RUL + \Delta Therms_{NR} \times EUL$$

Calculation Parameters

Table 3-211 Calculation Parameters

Variable	Description	Value	Units	Ref
ΔkWh	Annual electric energy savings	Calculated	kWh/yr	
$\Delta Therms$	Annual fuel savings	Calculated	Therms/yr	
ΔkW_{Peak}	Peak Demand Savings	Calculated	kW	
$\Delta Therms_{Peak}$	Daily peak fuel savings	Calculated	Therms/day	
ΔkWh_{Life}	Lifetime electric energy savings	Calculated	kWh	
$\Delta Therms_{Life}$	Lifetime fuel savings	Calculated	Therms	
Watts _b	Total Connected load of baseline fixture	Site-specific	Watts	
Watts _q	Total Connected load of delamped fixture	Site-specific	Watts	
Hrs	Deemed average hours of use per year	Look up in Table 3-212	Hrs/yr	[57]
HVAC _e	HVAC Interactive Factor for Annual Energy Savings	Look up in Table 3-213	N/A	[58][60]
HVAC _g	HVAC Interactive Factor for Annual Fuel Savings	Look up in Table 3-214	N/A	[61]
CF	Electric coincidence factor	Look up in Table 3-212	N/A	[57]
PDF	Gas peak day factor	Look up in Table 3-215	N/A	
EUL	Effective useful life	See Measure Life Section	Years	

Table 3-212 Hours of Use and Coincidence Factor by Building Type

Building Type	Sector	CF	Hours
Grocery	Large Commercial/Industrial & Small Commercial	0.96	7,134
Medical - Clinic	Large Commercial/Industrial & Small Commercial	0.8	3,909
Medical - Hospital	Large Commercial/Industrial & Small Commercial ¹¹⁵	0.8	8,760
Office	Large Commercial/Industrial	0.7	2,969
	Small Commercial	0.67	2,950
Other ¹¹⁶	Large Commercial/Industrial & Small Commercial	0.66	4,573
Retail	Large Commercial/Industrial	0.96	4,920
	Small Commercial	0.86	4,926
School	Large Commercial/Industrial & Small Commercial	0.50	2,575
Warehouse/ Industrial	Large Commercial/Industrial	0.7	4,116
	Small Commercial	0.68	3,799
Multifamily – Common Areas ¹¹⁷	Multifamily	0.86	5,950
Multifamily – In-Unit	Multifamily	0.59	679
Multifamily –Exterior	Multifamily	0.00	3,338
C&I Exterior	All C&I	0.00	4,380
C&I Parking Lots	All C&I	0.00	4,100
C&I Parking Garages	All C&I	0.00	4,368

Table 3-213 HVAC Interactive Effects

Building Type	HVAC Interactive Factor for Peak Demand Savings (HVAC _d)		HVAC Interactive Factor for Annual Energy Savings (HVAC _e)			
	AC (Utility)	AC (PJM)	AC/NonElec	AC/ElecRes	Heat Pump	NoAC/ElecRes
Office	0.35	0.32	0.10	-0.15	-0.06	-0.25

¹¹⁵ Assumes hospital operations are year round.

¹¹⁶ Per the NEEP Mid-Atlantic TRM, v7: "The "Other" building type should be used when the building type is known but not explicitly listed above. A description of the actual building type should be recorded in the project documentation. To encourage the use of building type-specific values, the assumed lighting coincidence factors for unknown building types have been set equal to the lowest values from the table."

¹¹⁷ NEEP Mid-Atlantic TRM V9, p. 24.

Building Type	HVAC Interactive Factor for Peak Demand Savings (HVAC _d)		HVAC Interactive Factor for Annual Energy Savings (HVAC _e)			
	AC (Utility)	AC (PJM)	AC/NonElec	AC/ElecRes	Heat Pump	NoAC/ElecRes
Retail	0.27	0.26	0.06	-0.17	-0.05	-0.23
Education	0.44	0.44	0.10	-0.19	-0.04	-0.29
Warehouse	0.22	0.23	0.02	-0.25	-0.11	-0.27
Other ¹¹⁸	0.34	0.32	0.08	-0.18	-0.07	-0.26
Exterior	0.00	0.00	0.00	0.00	0.00	0.00

Table 3-214 Interactive Factor (HVAC_g) for Annual Fuel Savings

Project Type	Fuel Type	Impact (MMBtu/Δkwh)
Large Retrofit (> 200 kW)	C&I Gas Heat	-0.0023
Large Retrofit (> 200 kW)	Oil	-0.0046
Small Retrofit (≤ 200 kW)	Gas Heat	-0.01075
Small Retrofit (> 200 kW)	Oil Heat	-0.00120
Exterior	0.00	0.00

Peak Factors

Table 3-215 Peak Factors

Peak Factor	Value	Ref
Electric Coincidence (CF)	Look up in Table 3-212	
Natural gas peak day factor (PDF)	See Appendix G: Natural Gas Peak Day Factors	

Measure Life

The remaining useful life (RUL) for existing equipment is limited to 1/3 of the effective useful life (EUL) of the equipment.

Table 3-216 Measure Life

Equipment	EUL	RUL	Ref
Delamping	16	5.33	[59]

¹¹⁸ Per the NEEP Mid-Atlantic TRM, v7: "The 'Other' building type should be used when the building type is known but not explicitly listed above. A description of the actual building type should be recorded in the project documentation."

References

- [57] Navigant, EmPOWER Maryland DRAFT Final Impact Evaluation Deemed Savings (June 1, 2017 – May 31, 2018) Commercial & Industrial Prescriptive, Small Business, and Direct Install Programs, (2018).
- [58] Navigant, *EmPOWER Maryland DRAFT Final Impact Evaluation Report Evaluation Year 4 (June 1, 2012 – May 31, 2013) Commercial & Industrial Prescriptive & Small Business Programs*, (2013)
- [59] GDS Associates, Measure Life Report, Residential and Commercial/Industrial Lighting and HVAC Measures, June 2007 available at https://library.cee1.org/sites/default/files/library/8842/CEE_Eval_MeasureLifeStudyLights&HVACGDS_1Jun2007.pdf
- [60] DNV KEMA (2013). *Impact Evaluation of 2010 Prescriptive Lighting Installations. Prepared for Massachusetts Energy Efficiency Program Administrators and Massachusetts Energy Efficiency Advisory*
- [61] Northeast Energy Efficiency Partnerships & KEMA, *C&I Lighting Load Shape Project FINAL Report - Prepared for the Regional Evaluation, Measurement and Verification Forum*. (2011).

3.7.4 EXIT SIGNS

Market	Commercial
Baseline Condition	EREP/DI
Baseline	Existing/Dual
End Use Subcategory	Equipment
Measure Last Reviewed	January 2023

Description

This measure relates to the installation of an exit sign illuminated with light emitting diodes (LED). This measure should be limited to early replacement applications. Note: While this measure is characterized as an early replacement, a dual baseline is not used as it is assumed that the existing fixture would have been maintained with new baseline lamps (and ballasts, if required) for the duration of the measure life.

Baseline Case

The baseline condition is an existing exit sign with a non-LED light-source.

Efficient Case

The efficient condition is a new exit sign illuminated with light emitting diodes (LED).

Annual Energy Savings Algorithms

Annual Electric Energy Savings

$$\Delta kWh = \frac{W_b - W_q}{1,000} \times Hrs \times (1 + HVAC_e)$$

Annual Fuel Savings

$$\Delta Therms = \frac{W_b - W_q}{1,000} \times Hrs \times HVAC_g$$

Peak Demand Savings

$$\Delta kW_{Peak} = \frac{W_b - W_q}{1,000} \times (1 + HVAC_d) \times CF$$

Daily Peak Fuel Savings

$$\Delta Therms_{Peak} = \Delta Therms \times PDF$$

Lifetime Energy Savings Algorithms

Lifetime Electric Energy Savings

$$\Delta kWh_{Life} = \Delta kWh \times EUL$$

Lifetime Fuel Savings

$$\Delta Therms_{Life} = \Delta Therms \times EUL$$

Dual:

Lifetime Electric Energy Savings

$$\Delta kWh_{Life} = \Delta kWh_{EREP} \times RUL + \Delta kWh_{NR} \times EUL$$

Lifetime Fuel Savings

$$\Delta Therms_{Life} = \Delta Therms_{EREP} \times RUL + \Delta Therms_{NR} \times EUL$$

Calculation Parameters

Table 3-217 Calculation Parameters

Variable	Description	Value	Units	Ref
ΔkWh	Annual electric energy savings	Calculated	kWh/yr	
$\Delta Therms$	Annual fuel savings	Calculated	Therms/yr	
ΔkW_{Peak}	Peak Demand Savings	Calculated	kW	
$\Delta Therms_{Peak}$	Daily peak fuel savings	Calculated	Therms/day	
ΔkWh_{Life}	Lifetime electric energy savings	Calculated	kWh	
$\Delta Therms_{Life}$	Lifetime fuel savings	Calculated	Therms	
W_b	Actual Connected load of existing exit sign	Site-specific, if unknown look up in Table 3-218	kW	
W_q	Actual Connected load of LED exit sign	Site-specific, if unknown look up in Table 3-218	kW	
Hrs	Average hours of use per year	Site-specific, if unknown use 8,760	Hours	
HVAC _e	HVAC Interactive Factor for Annual Energy Savings	Look up in Table 3-219	N/A	[62][60]
HVAC _g	HVAC Interactive Factor for Annual Fuel Savings	Look up in Table 3-220	N/A	[61]
HVAC _d	HVAC Interactive Factor for Peak Demand Savings	Look up in Table 3-219	N/A	[62][60]
CF	Electric coincidence factor	Look up in Table 3-221	N/A	

Variable	Description	Value	Units	Ref
PDF	Gas peak day factor	Look up in Table 3-221	N/A	
EUL	Effective useful life	See Measure Life Section	Years	

Table 3-218 Connected Load by Bulb Type

Type	Single-Sided kW	Dual-Sided kW
Incandescent	0.020	0.040
Fluorescent	0.009	0.020
LED	0.002	0.004

Table 3-219 HVAC Interactivity Factors – Electric

Building Type	HVAC Interactive Factor for Peak Demand Savings (HVAC _d)		HVAC Interactive Factor for Annual Energy Savings (HVAC _e)			
	AC (Utility)	AC (PJM)	AC/NonElec	AC/ElecRes	Heat Pump	NoAC/ElecRes
Office	0.35	0.32	0.10	-0.15	-0.06	-0.25
Retail	0.27	0.26	0.06	-0.17	-0.05	-0.23
Education	0.44	0.44	0.10	-0.19	-0.04	-0.29
Warehouse	0.22	0.23	0.02	-0.25	-0.11	-0.27
Other ¹¹⁹	0.34	0.32	0.08	-0.18	-0.07	-0.26

Table 3-220 HVAC Interactivity Factors – Fuel

Project Type	Fuel Type	Impact (Therms/kWh)
Large Retrofit (> 200 kW)	Gas Heat	-0.023
Large Retrofit (> 200 kW)	Oil	-0.046
Small Retrofit (≤ 200 kW)	Gas Heat	-0.1075
Small Retrofit (≤ 200 kW)	Oil Heat	-0.0120

¹¹⁹ Per the NEEP Mid-Atlantic TRM, v7: "The 'Other' building type should be used when the building type is known but not explicitly listed above. A description of the actual building type should be recorded in the project documentation."

Peak Factors

Table 3-221 Peak Factors

Peak Factor	Value	Ref
Electric coincidence factor (CF)	1.00	[64]
Natural gas peak day factor (PDF)	See Appendix G: Natural Gas Peak Day Factors	

Measure Life

The remaining useful life (RUL) for existing equipment is limited to 1/3 of the effective useful life (EUL) of the equipment.

Table 3-222 Measure Life

Equipment	EUL	RUL	Ref
Exit Signs	15	5	[65]

References

- [62] EmPOWER Maryland DRAFT Final Impact Evaluation Report Evaluation Year 4 (June 1, 2012 – May 31, 2013) Commercial & Industrial Prescriptive & Small Business Programs, Navigant, March 31, 2014. WHF values for Washington, D.C. and Delaware assume values from Maryland, Pepco and Maryland, DPL, respectively.
- [63] Rundquist, R A, Johnson, K F, and Aumann, D J. 1993. 1993 ASHRAE Journal:"Calculating lighting and HVAC interactions". Typical aspect ratio for perimeter zones. Heating factor applies to perimeter zoneheat, therefore it must be adjusted to account for lighting in core zones.
- [64] Efficiency Vermont Technical Reference Manual 2009-55, December 2008.
- [65] California Public Utilities Commission Database for Energy Efficient Resources (DEER) EUL Support Table for 2020, <http://www.deeresources.com/files/DEER2020/download/SupportTable-EUL2020.xlsx>.
- [66] DNV KEMA (2013). *Impact Evaluation of 2010 Prescriptive Lighting Installations. Prepared for Massachusetts Energy Efficiency Program Administrators and Massachusetts Energy Efficiency Advisory*
- [67] Northeast Energy Efficiency Partnerships & KEMA, *C&I Lighting Load Shape Project FINAL Report - Prepared for the Regional Evaluation, Measurement and Verification Forum*. (2011).

3.7.5 LED SIGN LIGHTING

Market	Commercial
Baseline Condition	RF/DI
Baseline	Existing/Dual
End Use Subcategory	Lighting
Measure Last Reviewed	January 2023

Description

This measure is applicable to the installation of LED sign lighting fixtures. This technology provides the required illumination at reduced input power. Typically, these signs are constructed from sheet metal sides forming the shape of letters and a translucent plastic lens. Luminance is most commonly provided by single or double strip neon lamps, powered by neon sign transformers. Retrofit kits are available to upgrade existing signage from neon to LED light sources, substantially reducing the electrical power and energy required for equivalent sign luminance. LED drivers can be either electronic switching or linear magnetic, with the electronic switching supplies being the most efficient. The on/off power switch may be found on either the power line or load side of the driver, with the line side location providing significantly lower standby losses when the sign is turned off and is not operating. All new open signs must meet UL-84 (UL-844) requirements. Replacement signs cannot use more than 20% of the input power of the sign that is being replaced.

Baseline Case

The baseline condition is fluorescent lighting or neon type illuminated LED open sign.

Efficient Case

The compliance condition is an LED type illuminated LED open sign.

Annual Energy Savings Algorithms

Annual Electric Energy Savings

$$\Delta kWh = \frac{W_b - W_q}{1,000} \times Hrs \times (1 + HVAC_c)$$

Annual Fuel Savings

$$\Delta Therms = \frac{W_b - W_q}{1,000} \times Hrs \times HVAC_g$$

Peak Demand Savings

$$\Delta kW_{Peak} = \frac{W_b - W_q}{1,000} \times (1 + HVAC_d) \times CF$$

Daily Peak Fuel Savings

$$\Delta Therms_{Peak} = \Delta Therms \times PDF$$

Lifetime Energy Savings Algorithms

Lifetime Electric Energy Savings

$$\Delta kWh_{Life} = \Delta kWh \times EUL$$

Lifetime Fuel Savings

$$\Delta Therms_{Life} = \Delta Therms \times EUL$$

Dual:

Lifetime Electric Energy Savings

$$\Delta kWh_{Life} = \Delta kWh_{EREP} \times RUL + \Delta kWh_{NR} \times EUL$$

Lifetime Fuel Savings

$$\Delta Therms_{Life} = \Delta Therms_{EREP} \times RUL + \Delta Therms_{NR} \times EUL$$

Calculation Parameters

Table 3-223 Calculation Parameters

Variable	Description	Value	Units	Ref
ΔkWh	Annual electric energy savings	Calculated	kWh/yr	
$\Delta Therms$	Annual fuel savings	Calculated	Therms/yr	
ΔkW_{Peak}	Peak Demand Savings	Calculated	kW	
$\Delta Therms_{Peak}$	Daily peak fuel savings	Calculated	Therms/day	
ΔkWh_{Life}	Lifetime electric energy savings	Calculated	kWh	
$\Delta Therms_{Life}$	Lifetime fuel savings	Calculated	Therms	
W_b	Equipment wattage for baseline condition	Site-specific, if unknown use 46	Watts	[68]
W_q	Equipment wattage for energy efficient condition	Site-specific	Watts	
$HVAC_c$	HVAC interaction factor for annual electric energy consumption	0 for Exterior and Unconditioned Spaces; otherwise see Appendix F: HVAC Interactivity Factors	N/A	

Variable	Description	Value	Units	Ref
HVAC _d	HVAC interaction factor at utility summer peak hour	0 for Exterior and Unconditioned Spaces; otherwise see Appendix F: HVAC Interactivity Factors	N/A	
HVAC _g	HVAC interaction factor for annual fuel consumption	0 for Exterior and Unconditioned Spaces; otherwise see Appendix F: HVAC Interactivity Factors	therm/kWh	
Hrs	Annual hours of operation	Site-specific; If unknown, for a signage with photocell control operate, use 4,380 hours; for a time switch control, use 2,190 hours. For business hours see Appendix D: HVAC Fan and Pump Operating Hours	Hrs	
1,000	Conversion factor, one kilowatt equals 1,000 watts	1,000	N/A	
CF	Electric coincidence factor	Lookup in Table 3-43	N/A	[69][70][71][72][73]
EUL	Effective useful life	See Measure Life Section	Years	

Table 3-224 CF by Building Type

Building Type	CF
Education	0.39
Exterior, Photocell-Controlled (All Building Types)	0.11
Exterior, All Other (All Building Types)	0.11
Grocery	0.99
Health	0.47
Industrial Manufacturing – 1 Shift	0.96
Industrial Manufacturing – 2 Shift	0.96
Industrial Manufacturing – 3 Shift	0.96
Institutional/Public Service	0.23

Building Type	CF
Lodging	0.38
Miscellaneous/Other	0.33
Multifamily Common Areas	0.73
Office	0.26
Parking Garages	0.98
Restaurant	0.55
Retail	0.56
Street Lighting	0.00
Warehouse	0.50
Outdoor	0.00

Peak Factors

Table 3-225 Peak Factors

Peak Factor	Value	Ref
Electric coincidence factor (CF)	Lookup in Table 3-43	[69][70][71][72][73]
Natural gas peak day factor (PDF)	See Appendix G: Natural Gas Peak Day Factors	

Measure Life

The remaining useful life (RUL) for existing equipment is limited to 1/3 of the effective useful life (EUL) of the equipment.

Table 3-226 Measure Life

Equipment	EUL	RUL	Ref
LED Sign Lighting	15	5	[68]

References

[68] Measured average demand data. Southern California Edison, “Replace Neon Open Sign with LED Open Sign”, Workpaper SCE13LG070, Revision 2, October 2015. Pg. 10.

[69] Illinois Statewide Technical Reference Manual for Energy Efficiency v7.0. Multifamily common area value based on DEER 2008. http://ilsagfiles.org/SAG_files/Technical_Reference_Manual/Version_7/Final_9-28-18/IL-TRM_Effective_010119_v7.0_Vol_2_C_and_I_092818_Final.pdf Accessed December 2018.

- [70] Pennsylvania Statewide Act 129 2014 Commercial & Residential Lighting Metering Study. Prepared for Pennsylvania Public Utilities Commission. January 13, 2015. <http://www.puc.pa.gov/pdocs/1340978.pdf>
- [71] U.S. Naval Observatory. Duration of Daylight/Darkness Table for One Year.
https://aa.usno.navy.mil/data/docs/Dur_OneYear.php Assumes values for Philadelphia.
- [72] Mid-Atlantic Technical Reference Manual v8.0,
[https://neep.org/sites/default/files/resources/Mid Atlantic TRM V7 FINAL.pdf](https://neep.org/sites/default/files/resources/Mid%20Atlantic%20TRM%20V7%20FINAL.pdf)
- [73] UI and CL&P Program Savings Documentation for 2013 Program Year, United Illuminating Company, September 2012.

3.7.6 INDOOR HORTICULTURE LED

Market	Commercial
Baseline Condition	NC/TOS/DI
Baseline	ISP/Dual
End Use Subcategory	Equipment
Measure Last Reviewed	January 2023

Description

The method below is applicable to the installation of LED fixtures intended for indoor horticultural use that meet the DesignLights Consortium (DLC) Horticultural Lighting Technical Requirements Version 3.0 (Hort V3.0). This measure shall be used only for New Construction or fixture additions. Savings are based on the difference between the photosynthetic photon efficacies (PPE) of the efficient fixture and an industry standard practice fixture.

Baseline Case

The baseline fixtures meet the indoor agriculture industry standard practice photosynthetic photon efficacies (PPE) of 1.7 micromoles per Joule.

Efficient Case

The efficient case is the installation of new DLC qualified LED indoor agriculture fixtures having a PPE that meet is or exceeds the DLC Hort 3.0 standard of 2.3 micromoles per joule.

Annual Energy Savings Algorithms

Annual Electric Energy Savings

$$\Delta kWh = \Delta kW \times hrs \times (1 + HVAC_e)$$

Where,

$$\Delta kW = N_q \times W_q \times \left(\frac{PPE_q}{PPE_b} - 1 \right) / 1000$$

Annual Fuel Savings

$$\Delta Therms = N/A$$

Peak Demand Savings

$$\Delta kW_{Peak} = \Delta kW \times CF \times (1 + HVAC_d)$$

Daily Peak Fuel Savings

$$\Delta Therms_{Peak} = N/A$$

Lifetime Energy Savings Algorithms

Lifetime Electric Energy Savings

$$\Delta kWh_{Life} = \Delta kWh \times EUL$$

Lifetime Fuel Savings

$$\Delta Therms_{Life} = N/A$$

Dual:

Lifetime Electric Energy Savings

$$\Delta kWh_{Life} = \Delta kWh_{EREP} \times RUL + \Delta kWh_{NR} \times EUL$$

Lifetime Fuel Savings

$$\Delta Therms_{Life} = N/A$$

Calculation Parameters

Table 3-227 Calculation Parameters

Variable	Description	Value	Units	Ref
ΔkWh	Annual electric energy savings	Calculated	kWh/yr	
ΔkW_{Peak}	Peak Demand Savings	Calculated	kW	
ΔkWh_{Life}	Lifetime electric energy savings	Calculated	kWh	
ΔkW	Change in connected load from baseline to efficient lighting level	Calculated	kW	
Hrs	Annual hours of operation	Site-specific	hours	
N_q	Number of energy efficient fixtures	Site-specific	fixtures	
W_q	Wattage of energy efficient fixtures	Site-specific	W	
PPE_q	Photosynthetic photon efficacy (PPE) of qualifying equipment	Site-specific	$\mu\text{mol}/\text{j}$	
PPE_b	Photosynthetic photon efficacy (PPE) of baseline equipment	1.7	$\mu\text{mol}/\text{j}$	[75][76]
$HVAC_e$	HVAC interactive effects for electricity consumption	0.21	N/A	[77]
$HVAC_d$	HVAC interactive effects for electricity peak demand	0.22	N/A	[77]
CF	Electric coincidence factor	Lookup in Table 3-228	N/A	

Variable	Description	Value	Units	Ref
PDF	Gas peak demand factor	Lookup in Table 3-228	N/A	
EUL	Effective useful life	See Measure Life Section	Years	

Peak Factors

Table 3-228 Peak Factors

Peak Factor	Value	Ref
Electric coincidence factor (CF)	1	[78]
Natural gas peak day factor (PDF)	N/A	

Measure Life

The remaining useful life (RUL) for existing equipment is limited to 1/3 of the effective useful life (EUL) of the equipment.

Table 3-229 Measure Life

Equipment	EUL	RUL	Ref
Indoor Horticulture LED	12	4	[79]

References

- [74] Radetsky, Leora, “LED and HID Horticultural Luminaire Testing Report Prepared for Lighting Energy Alliance Members and Natural Resources Canada.” Rensselaer Polytechnic Institute, May 3, 2018; <https://www.lrc.rpi.edu/programs/energy/pdf/HorticulturalLightingReport-Final.pdf>
- [75] Runkle, Erik and Bugbee, Bruce “Plant Lighting Efficiency and Efficacy; μmols per joule”, Greenhouse Product News: <https://gpnmag.com/article/plant-lighting-efficiency-and-efficacy-%CE%BCmol%C2%B7j-%C2%B9/>
- [76] “LED Grow Light Buyer’s Guide.” 2016. Chilled Tech-LED Grow Lights & Spectrum Control. October 22, 2016. https://chilledgrowlights.com/education/led_buyers_guide
- [77] *2022 Illinois Statewide Technical Reference Manual Version 10: Volume 2 Commercial and Industrial Measures.* (2022), Pg 38, https://www.ilsag.info/wp-content/uploads/IL-TRM_Effective_010122_v10.0_Vol_2_C_and_I_09242021.pdf
- [78] Indoor Horticulture Lighting Study, Sacramento Municipal Utility District, March 14, 2018; available at: <https://www.smud.org/-/media/Documents/Business-Solutions-and-Rebates/Advanced-Tech-Solutions/LED-Reports/Amplified-Farms-Indoor-Horticulture-LED-Study-Final.ashx>
- [79] California Public Utilities Commission EUL Table, version 027 (updated November 12, 2022). Accessed December 30, 2022. <https://www.caetrm.com/shared-data/value-table/EUL/>

3.8 MOTORS AND DRIVES

3.8.1 MOTORS

Market	Commercial
Baseline Condition	TOS/NC/EREP/DI
Baseline	Code/Existing/Dual
End Use Subcategory	Motors
Measure Last Reviewed	January 2023

Description

This measure covers the installation of high efficiency, three-phase electric motors of 200 hp or less in commercial and industrial applications. Estimated energy savings are based on increased operating efficiency.

Efficient motors generally run at slightly higher RPM than standard motors. Unless the motor drive system is modified to correct for higher RPM operation, the power delivered by the motor may increase. This increase in power delivery may negate the effects of improved efficiency. Therefore, when replacing a standard-efficiency motor, a high-efficiency motor with lower or equal full-load speed must be selected to prevent any negation of predicted energy savings resulting from a higher efficiency. To provide the correct flow, it may be necessary to adjust fan sheaves or pump-impeller diameters.

Baseline Case

The baseline condition is a three-phase electric motor of equivalent type, speed and horsepower. For TOS, NC, and NR, a minimally code compliant baseline should be applied. For EREP, the baseline will be of the existing equipment.

Efficient Case

The compliance condition is a three-phase electric HVAC fan or pump motor with a speed at or below that of the baseline motor and full-load efficiency exceeding the NEMA premium full-load efficiency.

Annual Energy Savings Algorithms

Annual Electric Energy Savings

Normal replacement, Time of Sale, and New Construction (compared to code baseline):

$$\Delta kWh_{NR/TOS/NC} = HP \times RLF \times 0.746 \times \left[\left(\frac{1}{Eff_b} \right) - \left(\frac{1}{Eff_q} \right) \right] \times FLH$$

Early replacement and DI (compared to existing baseline):

$$\Delta kWh_{EREP/DI} = HP \times RLF \times 0.746 \times \left[\left(\frac{1}{Eff_{ex}} \right) - \left(\frac{1}{Eff_q} \right) \right] \times FLH$$

Annual Fuel Savings

$$\Delta Therms = N/A$$

Peak Demand Savings

Normal replacement, Time of Sale, and New Construction (compared to code baseline):

$$\Delta kW_{Peak,NR/TOS/NC} = HP \times RLF \times 0.746 \times \left[\left(\frac{1}{Eff_b} \right) - \left(\frac{1}{Eff_q} \right) \right] \times CF$$

Early replacement and DI (compared to existing baseline):

$$\Delta kW_{Peak,EREP/DI} = HP \times RLF \times 0.746 \times \left[\left(\frac{1}{Eff_{ex}} \right) - \left(\frac{1}{Eff_q} \right) \right] \times CF$$

Daily Peak Fuel Savings

$$\Delta Therms_{Peak} = N/A$$

Lifetime Energy Savings Algorithms

Lifetime Electric Energy Savings

Normal replacement, Time of Sale, and New Construction:

$$\Delta kWh_{Life} = \Delta kWh_{NR/TOS/NC} \times EUL$$

Early replacement and DI:

$$\Delta kWh_{Life} = \Delta kWh_{EREP/DI} \times RUL + \Delta kWh_{NR/TOS/NC} \times (EUL - RUL)$$

Lifetime Fuel Savings

$$\Delta Therms_{Life} = N/A$$

Calculation Parameters

Table 3-230 Calculation Parameters

Variable	Description	Value	Units	Ref
$\Delta kWh_{NR/TOS/NC}$	Annual electric energy savings for Normal Replacement	Calculated	kWh/yr	
$\Delta kWh_{EREP/DI}$	Annual electric energy savings for Early Replacement	Calculated	kWh/yr	
$\Delta kW_{Peak,NR/TOS/NC}$	Peak Demand Savings for normal replacement	Calculated	kW	
$\Delta kW_{Peak,EREP/DI}$	Peak Demand Savings for early replacement	Calculated	kW	

Variable	Description	Value	Units	Ref
ΔkWh_{Life}	Lifetime electric energy savings	Calculated	kWh	
HP	Rated horsepower of the efficient equipment	Site-specific	HP	
Eff_q	Full-load efficiency of qualifying efficiency motor	Site-specific	N/A	
Eff_{ex}	Full-load efficiency of existing motor	Site-specific	N/A	
Eff_b	Full-load efficiency of code-compliant baseline motor	Look up in Table 3-231 & Table 3-232	N/A	[80]
RLF	Ratio of the peak annual motor load to the maximum connected load	Site-specific, if unknown, use 0.75	N/A	[81]
FLH	Full-load hours in the energy efficient case	Site-specific, if unknown look up in Table 3-233	Hrs	[82]
0.746	Unit conversion, kW/HP	0.746	kW/HP	
CF	Electric coincidence factor	Look up in Table 3-234	N/A	
PDF	Gas peak day factor	Look up in Table 3-234	N/A	
EUL	Effective useful life	See Measure Life Section	Years	

Table 3-231 Baseline Efficiencies for NEMA Design A and NEMA Design B Motors¹²⁰

Motor HP	Motor Nominal Full-Load Efficiencies							
	2 Pole (3600 RPM)		4 pole (1800 RPM)		6 Pole (1200 RPM)		8 Pole (900 RPM)	
	Enclosed	Open	Enclosed	Open	Enclosed	Open	Enclosed	Open
1	0.770	0.770	0.855	0.855	0.825	0.825	0.755	0.755
1.5	0.840	0.840	0.865	0.865	0.875	0.865	0.785	0.770
2	0.855	0.855	0.865	0.865	0.885	0.875	0.840	0.865
3	0.865	0.855	0.895	0.895	0.895	0.885	0.855	0.875
5	0.885	0.865	0.895	0.895	0.895	0.895	0.865	0.885
7.5	0.895	0.885	0.917	0.910	0.910	0.902	0.865	0.895
10	0.902	0.895	0.917	0.917	0.910	0.917	0.895	0.902

¹²⁰ Design indicates the torque/speed characteristics of the motor.

Design A: Maximum five percent slip, High to medium starting current, Normal locked rotor torque, Normal breakdown torque and Suited for a broad variety of applications, such as fans and pumps

Design B: Maximum five percent slip, Low starting current, High locked rotor torque, Normal starting torque, Normal breakdown torque and Suited for a broad variety of applications, such as fans and pumps -- common in HVAC application with fans, blowers and pumps

Motor HP	Motor Nominal Full-Load Efficiencies							
	2 Pole (3600 RPM)		4 pole (1800 RPM)		6 Pole (1200 RPM)		8 Pole (900 RPM)	
	Enclosed	Open	Enclosed	Open	Enclosed	Open	Enclosed	Open
15	0.910	0.902	0.924	0.930	0.917	0.917	0.895	0.902
20	0.910	0.910	0.930	0.930	0.917	0.924	0.902	0.910
25	0.917	0.917	0.93.6	0.936	0.930	0.930	0.902	0.910
30	0.917	0.917	0.936	0.941	0.930	0.936	0.917	0.917
40	0.924	0.924	0.941	0.941	0.941	0.941	0.917	0.917
50	0.930	0.930	0.945	0.945	0.941	0.94.1	0.924	0.924
60	0.936	0.936	0.950	0.950	0.945	0.945	0.924	0.930
75	0.936	0.936	0.954	0.950	0.945	0.945	0.936	0.941
100	0.941	0.936	0.954	0.954	0.950	0.950	0.936	0.941
125	0.950	0.941	0.954	0.954	0.950	0.950	0.941	0.941
150	0.950	0.941	0.958	0.958	0.958	0.954	0.941	0.941
200	0.954	0.950	0.962	0.958	0.958	0.954	0.945	0.941
250	0.958	0.950	0.962	0.958	0.958	0.958	0.950	0.950
300	0.958	0.954	0.962	0.958	0.958	0.958	N/A	N/A
350	0.958	0.954	0.962	0.958	0.958	0.958	N/A	N/A
400	0.958	0.958	0.962	0.958	N/A	N/A	N/A	N/A
450	0.958	0.962	0.962	0.962	N/A	N/A	N/A	N/A
500	0.958	0.962	0.962	0.962	N/A	N/A	N/A	N/A

Table 3-232 Baseline Motor Efficiencies for NEMA Design C Motors¹²¹

Motor HP	Motor Nominal Full-Load Efficiencies					
	4 Pole (1800 RPM)		6 Pole (1200 RPM)		8 Pole (900 RPM)	
	Enclosed	Open	Enclosed	Open	Enclosed	Open
1	0.855	0.855	0.825	0.825	0.755	0.755

¹²¹ Design indicates the torque/speed characteristics of the motor.

Design C: Maximum five percent slip, Low starting current, High locked rotor torque, Normal breakdown torque and Suited for equipment with high inertia starts, such as positive displacement pumps

Motor HP	Motor Nominal Full-Load Efficiencies					
	4 Pole (1800 RPM)		6 Pole (1200 RPM)		8 Pole (900 RPM)	
	Enclosed	Open	Enclosed	Open	Enclosed	Open
1.5	0.865	0.865	0.875	0.865	0.785	0.770
2	0.865	0.865	0.885	0.875	0.840	0.865
3	0.895	0.895	0.895	0.885	0.855	0.875
5	0.895	0.895	0.895	0.895	0.865	0.885
7.5	0.917	0.910	0.910	0.902	0.865	0.895
10	0.917	0.917	0.910	0.917	0.895	0.902
15	0.924	0.930	0.917	0.917	0.895	0.902
20	0.930	0.930	0.917	0.924	0.902	0.910
25	0.936	0.936	0.930	0.930	0.902	0.910
30	0.936	0.941	0.930	0.936	0.917	0.917
40	0.941	0.941	0.941	0.941	0.917	0.917
50	0.945	0.945	0.941	0.941	0.924	0.924
60	0.950	0.950	0.945	0.945	0.924	0.930
75	0.954	0.950	0.945	0.945	0.936	0.941
100	0.954	0.954	0.950	0.950	0.936	0.941
125	0.954	0.954	0.950	0.950	0.941	0.941
150	0.958	0.958	0.958	0.954	0.941	0.941
200	0.962	0.958	0.958	0.954	0.945	0.941

Table 3-233 Full-load Hours Based on Application and Building Type

Facility Type	Distribution Fan Motor	CHWP & Cooling Towers	Heating Pumps
Auto Related	4,056	1,878	5,376
Bakery	2,854	1,445	5,376
Banks, Financial Centers	3,748	1,767	5,376
Church	1,955	1,121	5,376
College - Cafeteria	6,376	2,713	5,376

Facility Type	Distribution Fan Motor	CHWP & Cooling Towers	Heating Pumps
College - Classes/Administrative	2,586	1,348	5,376
College - Dormitory	3,066	1,521	5,376
Commercial Condos	4,055	1,877	5,376
Convenience Stores	6,376	2,713	5,376
Convention Center	1,954	1,121	5,376
Court House	3,748	1,767	5,376
Dining: Bar Lounge/Leisure	4,182	1,923	5,376
Dining: Cafeteria / Fast Food	6,456	2,742	5,376
Dining: Family	4,182	1,923	5,376
Entertainment	1,952	1,120	5,376
Exercise Center	5,836	2,518	5,376
Fast Food Restaurants	6,376	2,713	5,376
Fire Station (Unmanned)	1,953	1,121	5,376
Food Stores	4,055	1,877	5,376
Gymnasium	2,586	1,348	5,376
Hospitals	7,674	3,180	5,376
Hospitals / Health Care	7,666	3,177	5,376
Industrial - 1 Shift	2,857	1,446	5,376
Industrial - 2 Shift	4,730	2,120	5,376
Industrial - 3 Shift	6,631	2,805	5,376
Laundromats	4,056	1,878	5,376
Library	3,748	1,767	5,376
Light Manufacturers	2,857	1,446	5,376
Lodging (Hotels/Motels)	3,064	1,521	5,376
Mall Concourse	4,833	2,157	5,376
Manufacturing Facility	2,857	1,446	5,376
Medical Offices	3,748	1,767	5,376
Motion Picture Theatre	1,954	1,121	5,376
Multi-Family (Common Areas)	7,665	3,177	5,376
Museum	3,748	1,767	5,376
Nursing Homes	5,840	2,520	5,376
Office (General Office Types)	3,748	1,767	5,376

Facility Type	Distribution Fan Motor	CHWP & Cooling Towers	Heating Pumps
Office/Retail	3,748	1,767	5,376
Parking Garages & Lots	4,368	1,990	5,376
Penitentiary	5,477	2,389	5,376
Performing Arts Theatre	2,586	1,348	5,376
Police / Fire Stations (24 Hr)	7,665	3,177	5,376
Post Office	3,748	1,767	5,376
Pump Stations	1,949	1,119	5,376
Refrigerated Warehouse	2,602	1,354	5,376
Religious Building	1,955	1,121	5,376
Residential (Except Nursing Homes)	3,066	1,521	5,376
Restaurants	4,182	1,923	5,376
Retail	4,057	1,878	5,376
School / University	2,187	1,205	5,376
Small Services	3,750	1,768	5,376
Sports Arena	1,954	1,121	5,376
Town Hall	3,748	1,767	5,376
Transportation	6,456	2,742	5,376
Warehouse (Not Refrigerated)	2,602	1,354	5,376
Waste Water Treatment Plant	6,631	2,805	5,376
Workshop	3,750	1,768	5,376

Peak Factors

Table 3-234 Peak Factors

Peak Factor	Value	Ref
Electric coincidence factor (CF)	0.8	[373]
Natural gas peak day factor (PDF)	N/A	

Measure Life

The remaining useful life (RUL) for existing equipment is limited to 1/3 of the effective useful life (EUL) of the equipment.

Table 3-235 Measure Life

Equipment	EUL	RUL	Ref
Motors	15	5	[84]

References

- [80] Energy Conservation Program: Energy Conservation Standards for Commercial and Industrial Electric Motors; Final Rule," 79 Federal Register 103, May 2014. <https://www.gpo.gov/fdsys/pkg/FR-2014-05-29/html/2014-11201.htm>
- [81] U.S. DOE, Determining Electric Motor Load and Efficiency, April 2014, <https://energy.gov/sites/prod/files/2014/04/f15/10097517.pdf>
- [82] Connecticut Program Savings Document, 12th Edition for 2017 Program Year, UIL Holdings Corporation and Eversource Energy Appendix 5, Hours of Use, October 2016.
- [83] New York Standard Approach for Estimating Energy Savings from Energy Efficiency Programs (TRM), Version 9, January 2022. [https://www3.dps.ny.gov/W/PSCWeb.nsf/96f0fec0b45a3c6485257688006a701a/72c23defff52920a85257f1100671bdd/\\$FILE/NYS%20TRM%20V9.pdf](https://www3.dps.ny.gov/W/PSCWeb.nsf/96f0fec0b45a3c6485257688006a701a/72c23defff52920a85257f1100671bdd/$FILE/NYS%20TRM%20V9.pdf).
- [84] California Public Utilities Commission Database for Energy Efficient Resources (DEER) EUL Support Table for 2020, <http://www.deeresources.com/files/DEER2020/download/SupportTable-EUL2020.xlsx>

3.8.2 VFD

Market	Commercial
Baseline Condition	RF/DI
Baseline	Existing/Dual
End Use Subcategory	Control
Measure Last Reviewed	January 2023

Description

This measure defines savings associated with installing a variable frequency drive on a motor of 200 hp or less for the following HVAC applications: supply air fans, return air fans, chilled water and condenser water pumps, hot water circulation pumps, water source heat pump circulation pumps, cooling tower fans, and boiler feed water pumps. VFD applications for other end uses are not covered under this measure.

Baseline Case

The baseline condition is a motor, 200 hp or less, without a VFD control.

Efficient Case

The efficient condition is a motor, 200 hp or less, with a VFD control.

Annual Energy Savings Algorithms

Annual Electric Energy Savings

$$\Delta kWh = 0.746 \times HP \times \frac{LF}{\eta_{motor}} \times hr \times ESF$$

Annual Fuel Savings

$$\Delta Therms = N/A$$

Peak Demand Savings

$$\Delta kW_{peak} = 0.746 \times HP \times \frac{LF}{\eta_{motor}} \times DSF$$

Daily Peak Fuel Savings

$$\Delta Therms_{peak} = N/A$$

Lifetime Energy Savings Algorithms

Lifetime Electric Energy Savings

$$\Delta kWh_{Life} = \Delta kWh \times EUL$$

Lifetime Fuel Savings

$$\Delta Therms_{Life} = N/A$$

Dual:

Lifetime Electric Energy Savings

$$\Delta kWh_{Life} = \Delta kWh_{ERP} \times RUL + \Delta kWh_{NR} \times EUL$$

Lifetime Fuel Savings

$$\Delta Therms_{Life} = N/A$$

Calculation Parameters

Table 3-236 Calculation Parameters

Variable	Description	Value	Units	Ref
ΔkWh	Annual electric energy savings	Calculated	kWh/yr	
ΔkW_{Peak}	Peak Demand Savings	Calculated	kW	
ΔkWh_{Life}	Lifetime electric energy savings	Calculated	kWh	
HP	Rated horsepower of the motor	Site-specific	HP	
hr	Annual run hours of the baseline motor	Lookup in Appendix D: HVAC Fan and Pump Operating Hours	hours	
LF	Load Factor	Site-specific, if unknown use fans: 0.76, pumps: 0.79	N/A	[85]
η_{motor}	Motor efficiency at the full-rated load.	Site-specific	N/A	
ESF	Energy Savings Factor	Lookup in Table 3-237	Fraction	[86]
DSF	Demand Savings Factor	Lookup in Table 3-237	Fraction	[86]
0.746	Conversion factor for HP to kW	0.746	kW/HP	
CF	Electric coincidence factor	Look up in Table 3-238	N/A	
PDF	Gas peak demand factor	Look up in Table 3-238	N/A	

Variable	Description	Value	Units	Ref
EUL	Effective useful life	See Measure Life Section	Years	

Table 3-237 Energy and Demand Savings Factors

Equipment Type	Baseline Control Type	ESF	DSF
HVAC Fan	Constant Volume	0.500	0.200
	Two-Speed	0.450	0.200
	Air Foil/Backward Incline	0.396	0.220
	Air Foil/Backward Incline with Inlet Guide Vanes	0.210	0.050
	Forward Curved	0.191	0.110
	Forward Curved with Inlet Guide Vanes	0.055	0.010
HVAC Pump	Constant Volume	0.661	0.210
	Throttle Valve	0.523	0.180

Peak Factors

Table 3-238 Peak Factors

Peak Factor	Value	Ref
Electric coincidence factor (CF)	N/A	
Natural gas peak day factor (PDF)	N/A	

Measure Life

This is a retrofit measure being applied to existing operational equipment (motor). Hence, the effective useful life (EUL) is the smaller of the host equipment remaining life or the full measure life of the upgrade which is 5 years [141].

References

- [85] Regional Technical Forum. Proposed Standard Savings Estimation Protocol for Ultra-Premium Efficiency Motors. November 5, 2012. Appendix C, Table 6.
- [86] 2019 Illinois Statewide Technical Reference Manual for Energy Efficiency Version 7.0. Volume 2: Commercial and Industrial Measures. September 28, 2018. https://www.ilsag.info/il_trm_version_7/
- [87] California Public Utilities Commission Database for Energy Efficient Resources (DEER) EUL Support Table for 2020, <http://www.deeresources.com/files/DEER2020/download/SupportTable-EUL2020.xlsx>

3.9 PLUG LOAD

3.9.1 NETWORK POWER MANAGEMENT

Market	Commercial
Baseline Condition	RF
Baseline	ISP
End Use Subcategory	Office Equipment
Measure Last Reviewed	December 2022

Description

This measure covers savings achieved by controlling the power management settings of desktop computers, monitors, and laptops through centralized computer power management software that is installed on a network of computers to monitor and record the usage and manage the power settings of all units. This software is implemented at the network level and manipulates the internal power settings of the central processing unit (CPU) and monitor.

Eligible software should be capable of the following:

- Apply specific power management policies to network groups and monitor workstation keyboard, mouse, CPU and disk activity in determining workstation idleness.
- Allow centralized control and override of computer power management settings of workstations which include both a computer monitor and CPU (i.e. a desktop or laptop computer on a distributed network).
- Wake-on-LAN capability to allow networked workstations to be remotely wakened from or placed into any power-saving mode and to remotely boot or shut down ACPI-compliant workstations.
- Software should be compatible with multiple operating systems and hardware configurations on the same network.
- Have capability to produce system reports to confirm the inventory and performance of equipment on which the software is installed.

Baseline Case

Desktop computer, monitor, or laptop in which power management settings are not controlled by centralized power management software.

Efficient Case

Qualifying software which controls computer and monitor power settings from a central location.

Annual Energy Savings Algorithms

Annual Electric Energy Savings

$$\Delta kWh = ESAV \times units$$

Annual Fuel Savings

$$\Delta Therms = N/A$$

Peak Demand Savings

$$\Delta kW_{Peak} = DSAV \times units$$

Daily Peak Fuel Savings

$$\Delta Therms_{Peak} = N/A$$

Lifetime Energy Savings Algorithms

Lifetime Electric Energy Savings

$$\Delta kWh_{Life} = \Delta kWh \times EUL$$

Lifetime Fuel Savings

$$\Delta Therms_{Life} = N/A$$

Calculation Parameters

Table 3-239 Calculation Parameters

Variable	Description	Value	Units	Ref
ΔkWh	Annual electric energy savings	Calculated	kWh/yr	[88]
ΔkW_{Peak}	Peak Demand Savings	Calculated	kW	
ΔkWh_{Life}	Lifetime electric energy savings	Calculated	kWh	
ESAV	Energy Savings per unit	Look up in Table 3-240	kWh/unit	
DSAV	Peak Demand Savings per unit	Look up in Table 3-240	kW/unit	
units	Number of units	Site-specific	units	
CF	Electric coincidence factor	See Peak Factors section	N/A	
EUL	Effective useful life	See Measure Life Section	Years	[89]

To determine savings, the per unit estimate in Table 3-240 will be multiplied by the number of units. The energy savings per unit includes power savings from the PC as well as the monitor. Default savings are based on the Low Carbon IT

Savings Calculator sourced from the ENERGY STAR website [88] and assumes the absence of an enabled network power management as the baseline condition.

Table 3-240 Network Power Controls, Per Unit Summary Table

Measure	Unit	Energy Savings (ESAV)	Peak Demand Savings (DSAV)
Network PC Plug Load Power Management Software	Workstation – Desktop Computer with Monitor	392	0.0527
Network PC Plug Load Power Management Software	Workstation – Laptop Computer with Monitor ¹²²	237	0.0319

Peak Factors

Peak savings are incorporated in the demand savings values above.

Measure Life

The effective useful life (EUL) is 5 years [89].

References

[88] ENERGYSTAR Low Carbon IT Savings Calculator:

<https://www.energystar.gov/sites/default/files/asset/document/LowCarbonITSavingsCalc.xlsx>

[89] Computers and peripheral equipment are considered 5-year property. 2016 IRS Publication 946.

<https://www.irs.gov/pub/irs-prior/p946--2016.pdf>.

¹²² Savings assume workstation includes desktop with monitor and laptop computer with laptop screen in use. Please refer to ENERGY STAR Low Carbon IT Savings Calculator for different workstation configurations [88].

3.9.2 OFFICE EQUIPMENT

Market	Commercial
Baseline Condition	TOS
Baseline	ISP
End Use Subcategory	Electronics
Measure Last Reviewed	December 2022

Description

This section provides deemed savings for installing ENERGYSTAR office equipment compliant with Energy Star Computer Specification ver. 8.0 compared to standard efficiency equipment in commercial applications. Per unit savings are primarily derived from the ENERGY STAR calculator for office equipment [90].

Baseline Case

The baseline condition is assumed to be standard equipment of similar type used in a commercial setting.

Efficient Case

The efficient condition is ENERGY STAR equipment meeting the current ENERGY STAR ver. 8.0 Eligibility Criteria [91] and used in a commercial setting.

Annual Energy Savings Algorithm

Annual Electric Energy Savings

$$\Delta kWh = ESF \times (1 + HVAC_e)$$

Annual Fuel Savings

$$\Delta Therms = ESF \times HVAC_g$$

Peak Demand Savings

$$\Delta kW_{Peak} = DSF \times (1 + HVAC_d)$$

Daily Peak Fuel Savings

$$\Delta Therms_{Peak} = \Delta Therms \times PDF$$

Lifetime Energy Savings Algorithms

Lifetime Electric Energy Savings

$$\Delta kWh_{Life} = \Delta kWh \times EUL$$

Lifetime Fuel Savings

$$\Delta Therms_{Life} = \Delta Therms \times EUL$$

Calculation Parameters

Table 3-241 Calculation Parameters

Variable	Description	Value	Units	Ref
ΔkWh	Annual electric energy savings	Calculated	kWh/yr	
$\Delta Therms$	Annual fuel savings	Calculated	Therms/yr	
$\Delta Therms_{Peak}$	Daily peak fuel savings	Calculated	Therms/day	
ΔkWh_{Life}	Lifetime electric energy savings	Calculated	kWh	
$\Delta Therms_{Life}$	Lifetime fuel savings	Calculated	Therms	
ESF	Energy savings factor	Look up in Table 3-242	kWh/yr	[90]
DSF	Electric Demand savings factor	Look up in Table 3-242	kW	[90]
HVAC _e	HVAC Interactive Factor for Annual Energy Savings	Look up in Table 3-243	N/A	[92][93]
HVAC _d	HVAC Interactive Factor for Peak Demand Savings	Look up in Table 3-243	N/A	[92][93]
HVAC _g	HVAC Interactive Factor for Annual Fuel Savings	Look up in Table 3-244	N/A	[94]
ΔkW_{Peak}	Peak Demand Savings	Look up in Table 3-242	kW	[90]
CF	Electric coincidence factor	Look up in Table 3-245	N/A	
PDF	Natural gas peak day factor (PDF)	Look up in Table 3-245	N/A	
EUL	Effective useful life of new unit	See Measure Life Section	Years	

Table 3-242 Office Equipment Energy and Demand Savings Factors per Unit

Measure	ESF (kWh)	DSF (kW)	Source
Computer (Desktop)	124	0.0161	1
Computer (Laptop)	37	0.0030	1
Fax Machine (laser)	16	0.0022	1
Copier (monochrome)	≤ 5images/min	0.0050	1

Measure		ESF (kWh)	DSF (kW)	Source
	5 < images/min ≤ 15	26	0.0035	
	15 < images/min ≤ 20	10	0.0011	
	20 < images/min ≤ 30	42	0.0057	
	30 < images/min ≤ 40	50	0.0068	
	40 < images/min ≤ 65	181	0.0244	
	65 < images/min ≤ 82	372	0.0502	
	82 < images/min ≤ 90	469	0.0633	
	> 90 images/min	686	0.0926	
Printer (laser, monochrome)	≤ 5 images/min	37	0.0050	1
	5 < images/min ≤ 15	26	0.0035	
	15 < images/min ≤ 20	24	0.0031	
	20 < images/min ≤ 30	42	0.0057	
	30 < images/min ≤ 40	50	0.0068	
	40 < images/min ≤ 65	181	0.0244	
	65 < images/min ≤ 82	372	0.0502	
	82 < images/min ≤ 90	542	0.0732	
	> 90 images/min	686	0.0926	
Printer (Ink Jet)		6	0.0008	1
Multifunction Device (laser, monochrome)	≤ 5 images/min	57	0.0077	1
	5 < images/min ≤ 10	48	0.0065	
	10 < images/min ≤ 26	52	0.0070	
	26 < images/min ≤ 30	93	0.0126	
	30 < images/min ≤ 50	248	0.0335	
	50 < images/min ≤ 68	420	0.0567	
	68 < images/min ≤ 80	597	0.0806	
	> 80 images/min	764	0.1031	
Multifunction Device (Ink Jet)		6	0.0008	1
Monitor		24	0.0032	1

Table 3-243 HVAC Interactive Effects

Building Type	HVAC Interactive Factor for Peak Demand Savings (HVACd)		HVAC Interactive Factor for Annual Energy Savings (HVACe)			
	AC (Utility)	AC (PJM)	AC/NonElec	AC/ElecRes	Heat Pump	NoAC/ElecRes
Office	0.35	0.32	0.10	-0.15	-0.06	-0.25
Retail	0.27	0.26	0.06	-0.17	-0.05	-0.23
Education	0.44	0.44	0.10	-0.19	-0.04	-0.29
Warehouse	0.22	0.23	0.02	-0.25	-0.11	-0.27
Other ¹²³	0.34	0.32	0.08	-0.18	-0.07	-0.26

Table 3-244 Interactive Factor (HVACg) for Annual Fuel Savings

Project Type	Fuel Type	Impact (MMBtu/ Δ kWh)
Large Retrofit (> 200 kW)	C&I Gas Heat	-0.0023
Large Retrofit (> 200 kW)	Oil	-0.0046
Small Retrofit (\leq 200 kW)	Gas Heat	-0.01075
Small Retrofit (> 200 kW)	Oil Heat	-0.00120

Peak Factors

Table 3-245 Peak Factors

Peak Factor	Value	Ref
Electric coincidence factor (CF)	Peak savings incorporated in the DSF Values found in Table 1-2 above	
Natural gas peak day factor (PDF)	See Appendix G: Natural Gas Peak Day Factors	

¹²³ Per the NEEP Mid-Atlantic TRM, v7: "The 'Other' building type should be used when the building type is known but not explicitly listed above. A description of the actual building type should be recorded in the project documentation."

Measure Life

Table 3-246 Measure Life [90]

Equipment	Measure Life
Computer	4 years
Monitor	4 years
Fax	4 years
Printer	5 years
Copier	6 years
Multifunction Device	6 years

References

- [90] ENERGY STAR Office Equipment Calculator. <https://dnr.mo.gov/sites/dnr/files/media/file/2021/01/office-equipment-calculator.xlsx>. Default values were used. Using a commercial office equipment load shape, the percentage of total savings that occur during the PJM peak demand period was calculated and multiplied by the energy savings. As of December 1, 2018, the published ENERGY STAR Office Equipment Calculator does not reflect the current specification for computers (ENERGY STAR® Program Requirements Product Specification for Computers Eligibility Criteria Version 8.0). As a result, the savings values for computers presented in this measure entry reflect savings for V6-compliant models. This characterization should be updated when an updated ENERGY STAR Office Equipment Calculator becomes available.
- [91] ENERGY STAR Product Specifications & Partner Commitments Search, <https://www.energystar.gov/products/spec>
- [92] Navigant, EmPOWER Maryland DRAFT Final Impact Evaluation Report Evaluation Year 4 (June 1, 2012 – May 31, 2013) Commercial & Industrial Prescriptive & Small Business Programs, (2013)
- [93] DNV KEMA (2013). Impact Evaluation of 2010 Prescriptive Lighting Installations. Prepared for Massachusetts Energy Efficiency Program Administrators and Massachusetts Energy Efficiency Advisory
- [94] Northeast Energy Efficiency Partnerships & KEMA, C&I Lighting Load Shape Project FINAL Report - Prepared for the Regional Evaluation, Measurement and Verification Forum. (2011).

3.9.3 SMART STRIP

Market	Commercial
Baseline Type	RF
Baseline	Existing
End Use Subcategory	Control
Measure Last Reviewed	December 2022

Description

This measure covers the installation of Tier 1 Advanced Power Strips (APS) in office workstations. The Tier 1 APS makes use of a control outlet to disconnect the controlled plugs when the load on the control outlet (usually a computer) is reduced below a threshold. In this case, the reduction below threshold of the control plug happens when the computer shuts down or enters standby mode. Therefore, the overall load of a centralized group of equipment (e.g., monitors and other peripherals for the computer) can be reduced. This measure assumes an office operating schedule of 7:30 AM to 5:30 PM from Monday to Fridays.

Baseline Case

The baseline condition is an office workstation with no plug load control system.

Efficient Case

The compliance condition is an office workstation with a tier 1 plug load control advanced power strip.

Annual Energy Savings Algorithm

Annual Electric Energy Savings

$$\Delta kWh = (\Delta kW_{wkday} \times (Hrs_{wkday} - Hrs_{wkday-open}) + \Delta kW_{wkend} \times (Hrs_{wkend} - Hrs_{wkend-open})) \times \frac{8,760}{168}$$

Annual Fuel Savings

$$\Delta Therms = N/A$$

Peak Demand Savings

$$\Delta kW_{Peak} = 0$$

Daily Peak Fuel Savings

$$\Delta Therms_{Peak} = N/A$$

Lifetime Energy Savings Algorithms

Lifetime Electric Energy Savings

$$\Delta kWh_{Life} = \Delta kWh \times EUL$$

Lifetime Fuel Savings

$$\Delta Therms_{Life} = N/A$$

Calculation Parameters

Table 3-247 Calculation Parameters

Variable	Description	Value	Units	Ref
ΔkWh	Annual electric energy savings	Calculated	kWh/yr	
ΔkW_{Peak}	Peak Demand Savings	0	kW	[97]
ΔkWh_{Life}	Lifetime electric energy savings	Calculated	kWh	
units	Number of measures installed under the program	Site-specific	N/A	
ΔkW_{wkday}	Average power reduction during weekday off hours	0.0315	kW	[96][97]
Hrs_{Swkday}	Total hours during the work week (Monday 7:30 AM to Friday 5:30 PM)	106	Hrs	
$Hrs_{Swkday-open}$	Hours the office is open during the work week	Site-specific. If unknown, assume 50	Hrs	
ΔkW_{wkend}	Average power reduction during weekend off hours	0.0067	kW	[96][97]
Hrs_{Swkend}	Total hours during the weekend (Friday 5:30 PM to Monday 7:30 AM)	62	Hrs	
$Hrs_{Swkend-open}$	Hours the office is open during the weekend	Site-specific, if unknown use 0	Hrs	
8,760	Hours in one year	8760	Hrs	
168	Hours in one week	168	Hrs	
EUL	Effective useful life	See Measure Life Section	Years	

Peak Factors

Table 3-248 Peak Factors

Peak Factor	Value	Ref
Electric coincidence factor (CF)	N/A	
Natural gas peak day factor (PDF)	N/A	

Measure Life

The expected lifetime of this measure is 4 years [96].

References

- [95] Sheppy, M, I Metzger, D Cutler, G Holland, and A Hanada. 2014. "Reducing Plug Loads in Office Spaces Hawaii and Guam Energy Improvement Technology Demonstration Project." <https://www.nrel.gov/docs/fy14osti/60382.pdf>.
- [96] David Rogers, Power Smart Engineering, "Smart Strip Electrical Savings and Usability," October 2008.
- [97] *New York Standard Approach for Estimating Energy Savings from Energy Efficiency Programs: Version 10* (2023) Pg 494.
[https://www3.dps.ny.gov/W/PSCWeb.nsf/96f0fec0b45a3c6485257688006a701a/72c23decff52920a85257f1100671bdd/\\$FILE/NYS%20TRM%20V10.pdf](https://www3.dps.ny.gov/W/PSCWeb.nsf/96f0fec0b45a3c6485257688006a701a/72c23decff52920a85257f1100671bdd/$FILE/NYS%20TRM%20V10.pdf)

3.9.4 UNINTERRUPTIBLE POWER SUPPLY

Market	Commercial
Baseline Condition	TOS
Baseline	Code
End Use Subcategory	Plug Load
Measure Last Reviewed	January 2023

Description

This measure is for replacing an inefficient uninterruptable power supply (UPS) with an efficient ENERGY STAR rated UPS within the scope of the Energy Star Uninterruptable Power Supply ver 2.0 Program Requirements. UPS units provide backup power in data centers and draw power constantly to keep their batteries charged. UPSs are utilized in many organizations to protect themselves from downtime with power distribution and avoid data processing errors due to downtimes. UPS systems are connected between the public power distribution system and mission critical loads.

This measure was developed to be applicable to the following program types: TOS. If applied to other program types, the measure savings should be verified through a custom calculation.

Baseline Case

The baseline condition is a non-ENERGY STAR UPS in a telecommunication or similar application meeting minimum Federal Efficiency Standards as defined in 10 CFR 430.32(z)(3)

Efficient Case

The efficient condition is a new UPS meeting ENERGY STAR UPS in a telecommunication or similar application meeting Energy Star UPS version 2.0 criteria. For single-normal mode UPSs, the installed system must meet or exceed the average loading-adjusted efficiency values required by the ENERGY STAR program.

Annual Energy Savings Algorithms

Annual Electric Energy Savings

$$\Delta kWh = Size \times \left(\frac{1}{Eff_{AVGBase}} - \frac{1}{Eff_{AVGee}} \right) \times EFLH$$

Annual Fuel Savings

$$\Delta Therms = N/A$$

Peak Demand Savings

$$\Delta kW_{Peak} = Size \times \left(\frac{1}{Eff_{AVGBase}} - \frac{1}{Eff_{AVGee}} \right) \times CF$$

Daily Peak Fuel Savings

$$\Delta Therms_{Peak} = N/A$$

Lifetime Energy Savings Algorithms

Lifetime Electric Energy Savings

$$\Delta kWh_{Life} = \Delta kWh \times EUL$$

Lifetime Fuel Savings

$$\Delta Therms_{Life} = N/A$$

Calculation Parameters

Table 3-249 Calculation Parameters

Variable	Description	Value	Units	Ref
ΔkWh	Annual electric energy savings	Calculated	kWh/yr	
ΔkW_{Peak}	Peak Demand Savings	Calculated	kW	
ΔkWh_{Life}	Lifetime electric energy savings	Calculated	kWh	
Size	Size of UPS in rated output power, kW	Site-specific	kW	
$Eff_{AVGbase}$	Efficiency of existing UPS	Site-specific, if unknown look up in Table 3-250	W	[98]
Eff_{AVGee}	Efficiency of new ENERGY STAR UPS	Site-specific, if unknown look up in Table 3-251	W or kW	[99]
E_{MOD}	An allowance of 0.004 for Modular UPSs applicable in the commercial 1500 – 10,000 W range	0.004	N/A	[99]
EFLH	Equivalent Full Load Hours	Look up in Table 3-252	hours	[100]
CF	Electric coincidence factor	Look up in Table 3-253	N/A	
PDF	Gas peak day factor	Look up in Table 3-253	N/A	
EUL	Effective useful life	See Measure Life Section	Years	[101]

Table 3-250 Efficiency of existing UPS

UPS Product Class	Rated Output Power (P) in watts	Minimum Efficiency
Voltage and Frequency Dependent (VFD)	$P \leq 300 \text{ W}$	$-1.20 \times 10^{-6} \times P^2 + 7.17 \times 10^{-4} \times P + 0.862$
	$300 \text{ W} < P \leq 700 \text{ W}$	$-7.85 \times 10^{-8} \times P^2 + 1.01 \times 10^{-4} \times P + 0.946$

UPS Product Class	Rated Output Power (P) in watts	Minimum Efficiency
	P > 700 W	$-7.23 \times 10^{-9} \times P^2 + 7.52 \times 10^{-6} \times P + 0.977$
Voltage Independent (VI)	P ≤ 300 W	$-1.20 \times 10^{-6} \times P^2 + 7.19 \times 10^{-4} \times P + 0.863$
	300 W < P ≤ 700 W	$-7.67 \times 10^{-8} \times P^2 + 1.05 \times 10^{-4} \times P + 0.947$
	P > 700 W	$-4.62 \times 10^{-9} \times P^2 + 8.54 \times 10^{-6} \times P + 0.979$
Voltage and Frequency Independent (VFI)	P ≤ 300 W	$-3.13 \times 10^{-6} \times P^2 + 1.96 \times 10^{-3} \times P + 0.543$
	300 W < P ≤ 700 W	$-2.60 \times 10^{-7} \times P^2 + 3.65 \times 10^{-4} \times P + 0.764$
	P > 700 W	$-1.70 \times 10^{-8} \times P^2 + 3.85 \times 10^{-5} \times P + 0.876$

Table 3-251 Efficiency of ENERGY STAR UPS Version 2.0

UPS Product Class	Rated Output Power (P) in watts	Minimum Efficiency
Voltage and Frequency Dependent (VFD)	P ≤ 350 W	$5.71 \times 10^{-5} \times P + 0.962$
	350 W < P ≤ 1.5 kW	0.982
	1.5 W < P ≤ 10 kW	$0.981 - E_{MOD}$
	P > 10 kW	0.97
Voltage Independent (VI)	P ≤ 350 W	$5.71 \times 10^{-5} \times P + 0.964$
	350 W < P ≤ 1.5 kW	0.984
	1.5 kW < P ≤ 10 kW	$0.980 - E_{MOD}$
	P > 10 kW	0.940
Voltage and Frequency Independent (VFI)	P ≤ 350 W	$0.011 \times \ln(P) + 0.824$
	350 W < P ≤ 1.5 kW	$0.011 \times \ln(P) + 0.824$
	1.5 W < P ≤ 10 kW	$0.0145 \times \ln(P) + 0.8 - E_{MOD}$
	P > 10 kW	$0.0058 \times \ln(P) + 0.886$

Table 3-252 Equivalent Full Load Hours

Rated Output Power (P) in Watts	UPS Product Class	Time spent at specified proportion of reference test load (t)				EFLH ¹²⁴
		25%	50%	75%	100%	
P ≤ 1.5 kW	VFD	0.2	0.2	0.3	0.3	5913
	VI or VFI	0	0.3	0.4	0.3	6570
1.5 kW < P ≤ 10 kW	VFD, VI, or VFI	0	0.3	0.4	0.3	6570
P > 10 kW	VFD, VI, or VFI	0.25	0.5	0.25	0	4380

Peak Factors

Table 3-253 Peak Factors

Peak Factor	Value	Ref
Electric coincidence factor (CF)	1.0	
Natural gas peak day factor (PDF)	N/A	

Measure Life

The effective useful life (EUL) is 10 years [101].

References

- [98] Code of Federal Regulations, Energy Conservation Standards for Uninterruptible Power Supplies, effective January 10, 2022 (10 CFR 430.32(z)(3). <https://www.ecfr.gov/current/title-10/chapter-II/subchapter-D/part-430/subpart-C/section-430.32>
- [99] ENERGY STAR Uninterruptible Power Supplies Final Version 2.0 Specification, effective January 1, 2019. <https://www.energystar.gov/sites/default/files/asset/document/ENERGY%20STAR%20Uninterruptible%20Power%20Supplies%20Final%20Version%202.0%20Specification.pdf>
- [100] Calculation and inputs provided in ENERGY STAR Uninterruptible Power Supplies Final Version 2.0 Specification.
- [101] California Municipal Utilities Association. Savings Estimation Technical Reference Manual 2017, Third Edition. Section 8.12, p. 8–15. https://www.cmua.org/files/CMUA-POU-TRM_2017_FINAL_12-5-2017%20-%20Copy.pdf

¹²⁴ EFLH = (t_{0.25} × 0.25 + t_{0.5} × 0.5 + t_{0.75} × 0.75 + t_{1.0} × 1.0) × 8760 hours

3.9.5 REFRIGERATED BEVERAGE VENDING MACHINE

Market	Commercial
Baseline Condition	TOS
Baseline	Code
End Use Subcategory	Plug Load
Measure Last Reviewed	January 2023

Description

This measure applies to new or rebuilt ENERGY STAR®, Class A, Class B, Combination A or Combination B refrigerated vending machines. ENERGY STAR® vending machines incorporate more efficient compressors, fan motors, and lighting systems as well as a low power mode option that allows the machine to be placed in low-energy lighting and/or low-energy refrigeration states during times of inactivity. Class A machines have 25% or more of the front surface area that is transparent; Class B machines have less than 25% of the front surface area that is transparent. Combination machines have separate refrigerated and non-refrigerated compartments.

Baseline Case

The baseline equipment is a new Class A, Class B, Combination A or Combination B refrigerated vending machine that meets Federal Energy Efficiency Standards for refrigerated vending machines as defined in 10 CFR 431.294.

Efficient Case

A new or rebuilt ENERGY STAR®, Class A, Class B, Combination A or Combination B refrigerated vending machine that meets Energy Star Vending Machine Ver 4.0 program requirements.

Annual Energy Savings Algorithms

Annual Electric Energy Savings

$$\Delta kWh = (kWh_b - kWh_q) \times Days$$

Annual Fuel Savings

$$\Delta Therms = N/A$$

Peak Demand Savings

$$\Delta kW_{Peak} = N/A$$

Daily Peak Fuel Savings

$$\Delta Therms_{Peak} = N/A$$

Lifetime Energy Savings Algorithms

Lifetime Electric Energy Savings

$$\Delta kWh_{Life} = \Delta kWh \times EUL$$

Lifetime Fuel Savings

$$\Delta Therms_{Life} = N/A$$

Calculation Parameters

Table 3-254 Calculation Parameters

Variable	Description	Value	Units	Ref
ΔkWh	Annual electric energy savings	Calculated	kWh/yr	
ΔkWh_{Life}	Lifetime electric energy savings	Calculated	kWh	
kWh_b	Energy usage of baseline vending machine	Site Specific, if unknown calculate using Table 3-255	kWh/day	[102]
kWh_q	Energy usage of ENERGY STAR vending machine	Site Specific, if unknown calculate using Table 3-255	kWh/day	[103]
V	Refrigerated Volume	Site Specific, if unknown use 23.62	Ft ³	[104]
Days	Days of vending machine operation per year	365.25	days	[105]
CF	Electric coincidence factor	Look up in Table 3-256	N/A	
PDF	Gas peak day factor	Look up in Table 3-256	N/A	
EUL	Effective useful life	See Measure Life Section	Years	[104]

Table 3-255 Energy Consumption Default Values

Equipment Class	Baseline (kWh_b) kWh/day	Energy Star (kWh_q) kWh/day
Class A	$0.052 \times V + 2.43$	$0.04836 \times V + 2.2599$
Class B	$0.052 \times V + 2.20$	$0.04576 \times V + 1.936$
Combination A	$0.086 \times V + 2.66$	$0.07998 \times V + 2.4738$
Combination B	$0.111 \times V + 2.04$	$0.09768 \times V + 1.7952$

Peak Factors

There are no peak demand savings because this measure is aimed to reduce demand during times of low beverage machine use, which will typically occur during off-peak hours.

Table 3-256 Peak Factors

Peak Factor	Value	Ref
Electric coincidence factor (CF)	N/A	
Natural gas peak day factor (PDF)	N/A	

Measure Life

The effective useful life (EUL) is 14 years [104].

References

- [102] 10 CFR §431.296 - Energy Conservation Standards for Refrigerated Bottled or Canned Beverage Vending Machines.
- [103] ENERGY STAR® Version 4.0 requirements for maximum daily energy consumption.
- [104] Navigant Consulting, *Energy Savings Potential and R&D Opportunities for Commercial Refrigeration*. September 2009, https://www1.eere.energy.gov/buildings/publications/pdfs/corporate/commercial_refrig_report_10-09.pdf.
- [105] ENERGY STAR. US Environmental Protection Agency and US Department of Energy. "ENERGY STAR Certified Vending Machines Spread Sheet" available at <https://www.energystar.gov/productfinder/download/certified-vending-machines/>

3.9.6 VENDING MACHINE CONTROLS

Market	Commercial
Baseline Condition	RF
Baseline	Existing
End Use Subcategory	Control
Measure Last Reviewed	January 2023

Description

This measure covers the installation of time clocks or occupancy sensors on refrigerated vending machines and novelty coolers to reduce compressor run time and lighting hours while ensuring units maintain desired product temperatures during occupied hours. This measure also covers the installation of either controls on non-refrigerated (snack) vending machines. In this case, savings are derived from a reduction in lighting hours during unoccupied hours. This measure is only applicable to vending machines and novelty coolers containing non-perishable products without a low power mode.

The time clock control mechanism is a programmed-schedule time clock that is assumed to be set to turn the equipment off coincident with the facility closing time and turn equipment on one hour before opening time to allow the products to return to the desired sale temperature.

The occupancy sensor control mechanism uses an infrared sensor to turn off the vending machine when the surrounding area is unoccupied. The device also monitors the ambient temperature and powers up the machine as required to keep products cool. Additionally, the sensor monitors the electrical current used by the machine to ensure it is not turned off during a compressor cycle to prevent a high head pressure start from occurring.

Baseline Case

The baseline equipment is assumed to be a standard efficiency refrigerated beverage vending machine, non-refrigerated snack vending machine, or glass front refrigerated cooler without a control system capable of powering down lighting and refrigeration systems during periods of inactivity.

Efficient Case

The efficient equipment is assumed to be a standard efficiency refrigerated beverage vending machine, non-refrigerated snack vending machine, or glass front refrigerated cooler with a control system capable of powering down lighting and refrigeration systems during periods of inactivity.

Annual Energy Savings Algorithms

Annual Electric Energy Savings

Refrigerated Vending Machine and Novelty Cooler

$$\Delta kWh = kW_{unit} \times [hrs_{off} + F_{ctrl} \times ESF \times (8,760 - hrs_{off})]$$

Non-Refrigerated Vending Machine

$$\Delta kWh = kW_{unit} \times [hrs_{off} + F_{ctrl} \times ESF \times (8,760 - hrs_{off})]$$

Annual Fuel Savings

$$\Delta Therms = N/A$$

Peak Demand Savings

$$\Delta kW_{Peak} = N/A$$

Daily Peak Fuel Savings

$$\Delta Therms_{Peak} = N/A$$

Lifetime Energy Savings Algorithms

Lifetime Electric Energy Savings

$$\Delta kWh_{Life} = \Delta kWh \times EUL$$

Lifetime Fuel Savings

$$\Delta Therms_{Life} = N/A$$

Calculation Parameters

Table 3-257 Calculation Parameters

Variable	Description	Value	Units	Ref
ΔkWh	Annual electric energy savings	Calculated	kWh/yr	
ΔkWh_{Life}	Lifetime electric energy savings	Calculated	kWh	
kW_{unit}	Vending machine power (kW)	Look up in Table 3-258	kW	[106][108]
hrs_{off}	Annual facility closed hours (Daily facility closed hours minus 1 multiplied by operating days)	Site-specific, if unknown see Appendix D: HVAC Fan and Pump Operating Hours	hours	
F_{ctrl}	Control type factor	Occupancy Sensor = 1 Time Clock = 0	N/A	
ESF	Energy savings of occupancy sensing control during building operating hours	0.1	N/A	[107]
CF	Electric coincidence factor	Look up in Table 3-259	N/A	
PDF	Gas peak day factor	Look up in Table 3-259	N/A	
EUL	Effective useful life	See Measure Life Section	Years	

Table 3-258 Vending Machine Power

Peak Factor	Value
Refrigerated beverage vending machine	0.4
Non-refrigerated snack vending machine	0.02
Glass front refrigerated coolers	0.46

Peak Factors**Table 3-259 Peak Factors**

Peak Factor	Value	Ref
Electric coincidence factor (CF)	N/A	
Natural gas peak day factor (PDF)	N/A	

Measure Life

The effective useful life (EUL) is 5 years [109].

References

- [106] 2021 Illinois Statewide Technical Reference Manual for Energy Efficiency Version 9: Volume 2 Commercial and Industrial Measures (2020) Pg. 574 https://www.ilsag.info/wp-content/uploads/IL-TRM_Effective_010121_v9.0_Vol_2_C_and_I_09252020_Final.pdf
- [107] Department of Energy, *Wireless Sensors for Lighting Energy Savings, Wireless Occupancy Sensors for Lighting Controls: An Applications Guide for Federal Facility Managers*, December 2019. https://betterbuildingssolutioncenter.energy.gov/sites/default/files/attachments/wireless_occupancy_sensor_guide.pdf
- [108] Southern California Edison, *Workpaper SCE17CS005, Revision 1, Beverage Merchandise Controller*, July 23, 2018. <http://deeresources.net/workpapers>
- [109] Energy Resource Solutions, *Measure Life Study: Prepared for the Massachusetts Joint Utilities*, November 2005, https://www.ers-inc.com/wp-content/uploads/2018/04/Measure-Life-Study_MA-Joint-Utilities_ERS.pdf.

3.9.7 ELECTRIC VEHICLE CHARGER

Market	Commercial
Baseline Condition	NC/RF
Baseline	ISP/Existing
End Use Subcategory	N/A
Measure Last Reviewed	January 2023

Description

Electric Vehicle Supply Equipment (EVSE) is the infrastructure that is used to charge electric vehicle batteries. At non-residential locations, EVSE may simply be a designated outlet in a parking lot or garage, or may include embedded intelligence that allows a fee to be charged for use of the EVSE and communications with a charging network such as ChargePoint. Additional functionality (the ability to charge a fee or communicate with a network) adds substantially to the cost of EVSE installation and often includes a monthly subscription fee.

Baseline Case

Level 1 - 120 volts Electric Vehicle Supply Equipment at a public or commercial location.

Efficient Case

Level 2 - 240 volts Electric Vehicle Supply Equipment at a public or commercial location.

Annual Energy Savings Algorithms

Annual Electric Energy Savings

$$\Delta kWh = 403 \times N_{EVSE}$$

Annual Fuel Savings

$$\Delta Therms = N/A$$

Peak Demand Savings

$$\Delta kW_{Peak} = N/A$$

Daily Peak Fuel Savings

$$\Delta Therms_{Peak} = N/A$$

Lifetime Energy Savings Algorithms

Lifetime Electric Energy Savings

$$\Delta kWh_{Life} = \Delta kWh \times EUL$$

Lifetime Fuel Savings

$$\Delta Therms_{Life} = N/A$$

Calculation Parameters

Table 3-260 Calculation Parameters

Variable	Description	Value	Units	Ref
ΔkWh	Annual electric energy savings	Calculated	kWh/yr	
ΔkWh_{Life}	Lifetime electric energy savings	Calculated	kWh	
403	Deemed Annual Energy Savings	403	kWh/yr	[110]
N_{EVSE}	Number of EVSE	N/A	N/A	[110]
CF	Electric coincidence factor	Look up in Table 3-261	N/A	[110]
PDF	Gas peak demand factor	Look up in Table 3-261	N/A	
EUL	Effective useful life	See Measure Life Section	Years	[110]

Peak Factors

Table 3-261 Peak Factors

Peak Factor	Value	Ref
Electric coincidence factor (CF)	75%	[110]
Natural gas peak day factor (PDF)	N/A	

Measure Life

The effective useful life (EUL) is the length of the warranty for EVSE given in the EVSE manufacturer websites. If unknown, use 10 years [110].

References

- [110] Vermont Energy Investment Corporation, *Transportation Technical Reference Manual: Guide to Characterize the Savings, Benefits, and Costs of Transportation Efficiency*, June 2014, Page 23 available at <https://www.veic.org/Media/default/documents/resources/manuals/veic-transportation-trm.pdf>

3.10 REFRIGERATION

3.10.1 ENERGY EFFICIENT GLASS DOORS ON VERTICAL OPEN REFRIGERATED CASES

Market	Commercial
Baseline Condition	RF/DI
Baseline	Existing/Dual
End Use Subcategory	Refrigeration
Measure Last Reviewed	November 2022

Description

This measure applies to retrofitting vertical, open, refrigerated display cases with high efficiency glass doors without anti-sweat heaters. The deemed savings factors are derived from the results of a controlled test designed to measure the impact of this measure. The results of the test were presented at the 2010 International Refrigeration and Air Conditioning conference.

Baseline Case

The baseline equipment is an existing vertical display case of medium temperature with no doors. The display cases should be medium temperature (typically for dairy, meats, or beverages) as opposed to low temperature (typically for frozen food and ice cream).

Efficient Case

The compliance condition is a vertical refrigerated display case fitted with glass doors without anti-sweat heaters.

Annual Energy Savings Algorithm

Annual Electric Energy Savings

$$\Delta kWh = CL \times (\Delta kWh/ft) \times \left(1 - \frac{hrs_{cooling}}{8,760} - \frac{COP_{ref}}{COP_{HVAC}} \right)$$

Where,

$$COP_{ref} = \frac{3.517}{(kW/ton)}$$

$$COP_{HVAC} = \frac{EER}{3.412}$$

Annual Fuel Savings

$$\Delta Therms = CL \times \frac{(\Delta kWh/ft) \times 3,412}{100,000} \times \frac{hrs_{heating}}{8,760} \times \frac{1}{Eff}$$

Peak Demand Savings

$$\Delta kW_{Peak} = CL \times \frac{(\Delta kWh/ft)}{8,760} \times CF$$

Daily Peak Fuel Savings

$$\Delta Therms_{Peak} = \Delta Therms \times PDF$$

Lifetime Energy Savings Algorithms

Lifetime Electric Energy Savings

$$\Delta kWh_{Life} = \Delta kWh \times EUL$$

Lifetime Fuel Savings

$$\Delta Therms_{Life} = \Delta Therms \times EUL$$

Dual:

Lifetime Electric Energy Savings

$$\Delta kWh_{Life} = \Delta kWh_{EREP} \times RUL + \Delta kWh_{NR} \times EUL$$

Lifetime Fuel Savings

$$\Delta Therms_{Life} = \Delta Therms_{EREP} \times RUL + \Delta Therms_{NR} \times EUL$$

Calculation Parameters

Table 3-262 Calculation Parameters

Variable	Description	Value	Units	Ref
ΔkWh	Annual electric energy savings	Calculated	kWh/yr	
$\Delta Therms$	Annual fuel savings	Calculated	Therms/yr	
ΔkW_{Peak}	Peak Demand Savings	Calculated	kW	
$\Delta Therms_{Peak}$	Daily peak fuel savings	Calculated	Therms/day	
ΔkWh_{Life}	Lifetime electric energy savings	Calculated	kWh	
$\Delta Therms_{Life}$	Lifetime fuel savings	Calculated	Therms	
CL	Case Length, open length of the refrigerated case	Site-specific	ft	
$\Delta kWh/ft$	Annual electric energy savings per foot of door opening	Look up in Table 3-263	kWh/yr-ft	[111]

Variable	Description	Value	Units	Ref
COP _{ref}	Coefficient of performance of refrigeration equipment	Calculated	N/A	
kW/ton	Rated efficiency of the compressor in input kW per ton of refrigeration capacity	Site-specific	kW/ton	
COP _{HVAC}	Coefficient of performance of heating, ventilation, and cooling equipment	Site-specific. If unknown, look up in Table 3-264	N/A	[112]
Eff	Fossil fuel-fired heating system efficiency	Site-specific ¹²⁵ . If unknown, use 0.8		[113]
Hrs _{cooling}	Cooling HVAC load hours	Site-specific	Hours	
Hrs _{heating}	Heating HVAC load hours	Site-specific	hrs	
3,412	Conversion factor from kWh to Btu	3,412	Btu/kWh	
8,760	Number of hours in a year	8760	Hours	
100,000	Conversion factor from Btu to therms	100,000	Btu/therm	
CF	Coincidence factor	Look up in Table 3-265	N/A	
PDF	Peak day factor	Look up in Table 3-265	N/A	
EUL	Effective useful life	See Measure Life Section	Years	
RUL	Remaining useful life of existing unit	See Measure Life Section	Years	

Table 3-263 Annual electric energy savings per foot of door opening

Door Type	Δ kWh/ft ¹²⁶
High-Efficiency Doors on Cooler	477
High-Efficiency Doors on Freezer	747
Standard Doors on Cooler	183
Standard Doors on Freezer	392

Table 3-264 Coefficient of performance of HVAC systems

Location ¹²⁷	COP _{HVAC}
Grocery Store	2.93
Other	3.57

¹²⁵ E_c, E_t or AFUE shall be used, based on nameplate rating metric of existing equipment

¹²⁶ Fricke, Brian and Becker, Bryan, "Energy Use of Doored and Open Vertical Refrigerated Display Cases". Energy savings of high efficiency doors are calculated by eliminating anti-condensation heater energy draw and proportionally reducing associated work required from the refrigeration equipment while assuming an HVAC system COP of 3.28, refrigeration COP of 3.03 for coolers and 1.66 for freezers. Measured energy savings on medium temperature units was adjusted with COP_{cooler}/COP_{freezer} ratios to develop savings for standard doors installed on freezer units.

¹²⁷ Grocery Store default assumes a 25-ton packaged RTU (cooling only); Other default assumes a 10-ton packaged RTU (cooling only)

Peak Factors

Table 3-265 Peak Factors

Peak Factor	Value	Ref
Electric coincidence factor (CF)	1.0 ¹²⁸	[114]
Natural gas peak day factor (PDF)	See Appendix G: Natural Gas Peak Day Factors	

Measure Life

The remaining useful life (RUL) for existing equipment is limited to 1/3 of the effective useful life (EUL) of the equipment.

Table 3-266 Measure Life

Equipment	EUL	RUL	Ref
Case Doors	4	1.3	[115]

References

- [111] Fricke, Brian and Becker, Bryan, "Energy Use of Doored and Open Vertical Refrigerated Display Cases" (2010). International Refrigeration and Air Conditioning Conference. Paper 1154. <http://docs.lib.purdue.edu/iracc/1154>
- [112] ASHRAE 90.1 2010 Energy Standard for Buildings Except Low Rise Residential Buildings: Standard for Unitary HVAC. <https://www.ashrae.org/technical-resources/standards-and-guidelines>
- [113] Gas boiler efficiency of 80% -ASHRAE Standards 90.1-2007 and 2016, Energy Standard for Buildings Except Low Rise Residential Buildings, Table 6.8.1F. <https://www.ashrae.org/technical-resources/standards-and-guidelines>
- [114] New York Standard Approach for Estimating Energy Savings from Energy Efficiency Programs, Version 10, January 2023
- [115] California Public Utilities Commission Database for Energy Efficient Resources (DEER) EUL Support Table for 2020. <http://www.deeresources.com/files/DEER2020/download/SupportTable-EUL2020.xlsx>.

¹²⁸ No source specified – update pending availability and review of applicable references.

3.10.2 DOOR CLOSER

Market	Commercial
Baseline Condition	RF
Baseline	Existing
End Use Subcategory	Controls
Measure Last Reviewed	January 2023

Description

This section provides energy savings algorithms for the installation of auto-closer to the main insulated opaque door(s) of a walk-in freezer or cooler. Auto-closers can reduce the amount of time that doors are open, thereby reducing infiltration and refrigeration loads. This measure applies to retrofit of doors not previously equipped with auto-closers, and assume the doors have strip curtains.

The auto-closer must be able to firmly close the door when it is within one inch of full closure. The walk-in door perimeter must be ≥ 16 feet.

Baseline Case

Walk in cooler/freezer without an auto closer and the doors have strip curtains.

Efficient Case

Walk in cooler/freezer with an auto closer.

Annual Energy Savings Algorithms

Annual Electric Energy Savings

Cooler Door:

$$\Delta kWh = \Delta kWh_{cooler}$$

Freezer Door:

$$\Delta kWh = \Delta kWh_{freezer}$$

Annual Fuel Savings

$$\Delta Therms = N/A$$

Peak Demand Savings

Cooler Door:

$$\Delta kW_{Peak} = \Delta kW_{cooler}$$

Freezer Door:

$$\Delta kW_{Peak} = \Delta kW_{freezer}$$

Daily Peak Fuel Savings

$$\Delta Therms_{Peak} = N/A$$

Lifetime Energy Savings Algorithms

Lifetime Electric Energy Savings

$$\Delta kWh_{Life} = \Delta kWh \times EUL$$

Lifetime Fuel Savings

$$\Delta Therms_{Life} = N/A$$

Calculation Parameters

Table 3-267 Calculation Parameters

Variable	Description	Value	Units	Ref
ΔkWh	Annual electric energy savings	Calculated	kWh/yr	
ΔkW_{Peak}	Peak Demand Savings	Calculated	kW	
ΔkWh_{Life}	Lifetime electric energy savings	Calculated	kWh	
ΔkWh_{cooler}	Annual kWh savings for main cooler doors	737	kWh/yr	[116][117]
$\Delta kWh_{freezer}$	Annual kWh savings for main freezer doors	1,997	kWh/yr	[116][117]
ΔkW_{cooler}	Summer peak kW savings for main cooler doors	0.463	kW	[116][117]
$\Delta kW_{freezer}$	Summer peak kW savings for main freezer doors	0.488	kW	[116][117]
CF	Electric coincidence factor	Lookup in Table 3-268	N/A	
EUL	Effective useful life	See Measure Life Section	Years	

Peak Factors

Peak demand is accounted for in the deemed savings values in this measure.

Table 3-268 Peak Factors

Peak Factor	Value	Ref
Electric coincidence factor (CF)	1.0	[116]
Natural gas peak day factor (PDF)	N/A	

Measure Life

The effective useful life (EUL) is 8 years [118].

References

- [116] *Technical Reference Manual Volume 3: Commercial and Industrial Measures* (State of Pennsylvania, 2019), Pg 172 <https://www.puc.pa.gov/filing-resources/issues-laws-regulations/act-129/technical-reference-manual/>
- [117] Southern California Edison, "Refrigerated Storage Auto Closer", Workpaper SCE17RN024, Measure R79 (Cooler) & R80 (Freezer). <http://www.deeresources.net/workpapers>.
- [118] "DEER2014-EUL-table-update_2014-02-05". 2014. Deeresources.com. Accessed December 12, 2022. http://www.deeresources.com/files/DEER2013codeUpdate/download/DEER2014-EUL-table-update_2014-02-05.xlsx

3.10.3 DOOR GASKETS

Market	Commercial
Baseline Condition	RF/DI
Baseline	Existing/Dual
End Use Subcategory	Load reduction
Measure Last Reviewed	January 2023

Description

This measure involves the replacement of worn-out gaskets with new, better-fitting gaskets on the doors of walk-in and/or reach-in coolers and freezers. When damaged and/or missing, the warmer, more humid air present in the store will infiltrate the case, increasing the refrigeration system load while often reducing the efficiency of the evaporator unit as a result of additional frost accumulation. Replacing the damaged gaskets reduces compressor run time and improves the overall heat removal effectiveness of the cooler/freezer.

Baseline Case

The baseline condition is a low-temperature walk-in and/or reach-in freezer and/or a medium-temperature walk-in and/or reach-in with damaged and/or missing gaskets with at least six inches of damage for reach-in units and at least two feet of damage for walk-in units.

Efficient Case

The efficient case is the installation of new, tight fitting door gaskets to reduce infiltration.

Annual Energy Savings Algorithms

Annual Electric Energy Savings

$$\Delta kWh = \frac{\Delta kWh}{Door} \times Doors$$

Annual Fuel Savings

$$\Delta Therms = N/A$$

Peak Demand Savings

$$\Delta kW_{Peak} = \frac{\Delta kW}{Door} \times Doors$$

Daily Peak Fuel Savings

$$\Delta Therms_{Peak} = N/A$$

Lifetime Energy Savings Algorithms

Lifetime Electric Energy Savings

$$\Delta kWh_{Life} = \Delta kWh_{EREP} \times RUL + \Delta kWh_{NR} \times EUL$$

Lifetime Fuel Savings

$$\Delta Therms_{Life} = \Delta Therms_{EREP} \times RUL + \Delta Therms_{NR} \times EUL$$

Calculation Parameters

Table 3-269 Calculation Parameters

Variable	Description	Value	Units	Ref
ΔkWh	Annual electric energy savings	Calculated	kWh/yr	
ΔkW_{Peak}	Peak Demand Savings	Calculated	kW	
ΔkWh_{Life}	Lifetime electric energy savings	Calculated	kWh	
$\Delta kWh/Door$	Annual Energy Savings per Foot of gasket	Lookup in Table 3-270	kWh	[119][120]
$\Delta kW/Door$	Demand Savings per Foot of gasket	Lookup in Table 3-270	kW	[119][120]
Doors	Total number of gasket doors replaced	Site-specific	N/A	[119][120]
CF	Electric coincidence factor	Lookup in Table 3-271	N/A	
EUL	Effective useful life	See Measure Life Section	Years	[121]
RUL	Remaining useful life of existing unit	See Measure Life Section	Years	

Table 3-270 Door Gasket Savings Per Foot of Gasket for Walk-in and Reach-in Coolers and Freezers

Type	Coolers		Freezers	
	$\Delta kW/door$	$\Delta kWh/door$	$\Delta kW/door$	$\Delta kWh/door$
Reach-in	0.032	248	0.032	243
Walk-in	0.027	204	0.045	347

Peak Factors

Table 3-271 Peak Factors

Peak Factor	Value	Ref
Electric coincidence factor (CF)	1.0	
Natural gas peak day factor (PDF)	N/A	

Measure Life

The remaining useful life (RUL) for existing equipment is limited to 1/3 of the effective useful life (EUL) of the equipment.

Table 3-272 Measure Life

Equipment	EUL	RUL	Ref
Door Gaskets	4	1.3	[121]

References

- [119] Database for UES Measures, Regional Technical Forum. Door Gasket Replacement, version 1.5. December 2016. <https://rtf.nwcouncil.org/measure/door-gasket-replacement>
- [120] Pennsylvania TRM 2021, August 2019 available at <https://www.puc.pa.gov/filing-resources/issues-laws-regulations/act-129/technical-reference-manual/>
- [121] California Public Utilities Commission Database for Energy Efficient Resources (DEER) EUL Support Table for 2020, <http://www.deeresources.com/files/DEER2020/download/SupportTable-EUL2020.xlsx>.

3.10.4 NIGHT COVERS

Market	Commercial
Baseline Condition	RF/DI
Baseline	Existing/Dual
End Use Subcategory	Refrigeration
Measure Last Reviewed	November 2022

Description

This measure covers the installation of retractable curtains on open horizontal or multi-deck refrigerated display cases in grocery stores. These covers serve as a barrier between the contents of the refrigerated case and the ambient air during off-business hours. They conserve energy by reducing the infiltration of ambient air into the refrigerated space, thereby reducing the load on the refrigeration system. Grocery stores operating 24 hours per day are not eligible for energy savings.

Baseline Case

The baseline condition is a vertical or horizontal open refrigerated display case left uncovered during off-business hours and meeting the minimum federal energy standards presented in Table 3-274 and Table 3-275 [122]. *Equipment with an operating temperature above 32°F is classified as Medium with a rating temperature of 38°F, while equipment with an operating temperature of 32°F or below is classified as Low with a rating temperature of 0°F. Ice Cream freezers have a rating temperature of -15°F and operate at temperatures below -5°F.*

Total Daily Energy Consumption (TDEC) shall be calculated per Table 3-274 and Table 3-275 for the appropriate display case type, configuration and rating temperature. For refrigeration equipment with two or more compartments (i.e. hybrid refrigerators, freezers, refrigerator-freezers and non-hybrid refrigerator freezers), the TDEC shall be established as the sum of the TDEC values associated with each component compartment.

Efficient Case

The compliance condition is a vertical or horizontal open refrigerated display case with retractable night covers installed.

Operating Hours

Energy savings are based on installation of refrigerated case night covers in an 18-hour supermarket assumed to operate 365 days per year. Therefore, the annual hours that night covers are assumed to be in use are $(24 - 18) \times 365 = 2,190$ hours [123].

Annual Energy Savings Algorithm

Annual Electric Energy Savings

$$\Delta kWh = TDEC \times ESF \times 365$$

Annual Fuel Savings

$$\Delta Therms = N/A$$

Peak Demand Savings

$$\Delta kW_{Peak} = 0$$

Daily Peak Fuel Savings

$$\Delta Therms_{Peak} = N/A$$

Lifetime Energy Savings Algorithm

Lifetime Electric Energy Savings

$$\Delta kWh_{Life} = \Delta kWh_{EREP} \times RUL + \Delta kWh_{NR} \times EUL$$

Lifetime Fuel Savings

$$\Delta Therms_{Life} = N/A$$

Calculation Parameters

Table 3-273 Calculation Parameters

Variable	Description	Value	Units	Ref
ΔkWh	Annual electric energy savings	Calculated	kWh/yr	
ΔkW_{Peak}	Peak Demand Savings	Calculated	kW	
ΔkWh_{Life}	Lifetime electric energy savings	Calculated	kWh	
TDA ¹²⁹	Total Display Area of the open case	Site-specific	Ft ²	
units	Number night covers installed	Site-specific	N/A	
TDEC	Total Daily Energy Consumption	Look up in Table 3-274, Table 3-275	kWh/day	[122]
ESF	Energy Savings Factor	0.09	N/A	[123]
365	Number of days in a year	365	days/yr	
EUL	Effective useful life	See Measure Life Section	Years	
RUL	Remaining useful life of existing unit	See Measure Life Section	Years	

¹²⁹ TDA = L * H, where L is length of the display case opening (ft) and H is height (vertical) or depth (horizontal) of the display case opening (ft). These parameters are site specific.

**Table 3-274 Baseline Efficiencies for Refrigerators, Freezers, or Refrigerator-freezers
Manufactured on or after March 27, 2017**

Equipment Family	Condensing Unit Configuration	Rating Temperature	TDEC (kWh/day)
Vertical Open	Remote Condensing	Medium (38°F)	0.64 x TDA + 4.07
Vertical Open	Remote Condensing	Low (0°F)	2.20 x TDA + 6.85
Vertical Open	Remote Condensing	Ice Cream (-15°F)	2.79 x TDA + 8.70
Vertical Open	Self-Contained	Medium (38°F)	1.69 x TDA + 4.71
Vertical Open	Self-Contained	Low (0°F)	4.25 x TDA + 11.82
Vertical Open	Self-Contained	Ice Cream (-15°F)	5.40 x TDA + 15.02
Horizontal Open	Remote Condensing	Medium (38°F)	0.35 x TDA + 2.88
Horizontal Open	Remote Condensing	Low (0°F)	0.55 x TDA + 6.88
Horizontal Open	Remote Condensing	Ice Cream (-15°F)	0.70 x TDA + 8.74
Horizontal Open	Self-Contained	Medium (38°F)	0.72 x TDA + 5.55
Horizontal Open	Self-Contained	Low (0°F)	1.90 x TDA + 7.08
Horizontal Open	Self-Contained	Ice Cream (-15°F)	2.42 x TDA + 9.00

**Table 3-275 Baseline Efficiencies for Refrigerators, Freezers, and Refrigerator-freezers
Manufactured before March 27, 2017**

Equipment Family	Condensing Unit Configuration	Rating Temperature	TDEC (kWh/day)
Vertical Open	Remote Condensing	Medium (38°F)	0.82 x TDA + 4.07
Vertical Open	Remote Condensing	Low (0°F)	2.27 x TDA + 6.85
Vertical Open	Remote Condensing	Ice Cream (-15°F)	2.89 x TDA + 8.70
Vertical Open	Self-Contained	Medium (38°F)	1.74 x TDA + 4.71
Vertical Open	Self-Contained	Low (0°F)	4.37 x TDA + 11.82
Vertical Open	Self-Contained	Ice Cream (-15°F)	5.55 x TDA + 15.02
Horizontal Open	Remote Condensing	Medium (38°F)	0.35 x TDA + 2.88
Horizontal Open	Remote Condensing	Low (0°F)	0.57 x TDA + 6.88
Horizontal Open	Remote Condensing	Ice Cream (-15°F)	2.44 x TDA + 9.00
Horizontal Open	Self-Contained	Medium (38°F)	0.77 x TDA + 5.55
Horizontal Open	Self-Contained	Low (0°F)	1.92 x TDA + 7.08
Horizontal Open	Self-Contained	Ice Cream (-15°F)	2.44 x TDA + 9.00

Peak Factors

Table 3-276 Peak Factors

Peak Factor	Value	Ref
Electric coincidence factor (CF)	N/A	
Natural gas peak day factor (PDF)	N/A	

Measure Life

The remaining useful life (RUL) for existing equipment is limited to 1/3 of the effective useful life (EUL) of the equipment.

Table 3-277 Measure Life

Equipment	EUL	RUL	Ref
Night Covers	5	1.67	[124]

References

- [122] 10 CFR 431.66 Energy conservation standards and their effective dates.
<https://www.ecfr.gov/current/title-10/chapter-II/subchapter-D/part-431#431.66>
- [123] Southern California Edison, Effects of the Low Emissivity Shields on Performance and Power Use of a Refrigerated Display Case, August 1997. https://www.econofrost.com/acrobat/sce_report_long.pdf
- [124] DEER 2014 EUL ID: GrocDisp-DispCvrs.

3.10.5 STRIP CURTAINS

Market	Commercial
Baseline Condition	RF/DI
Baseline	Existing/Dual
End Use Subcategory	Load Reduction
Measure Last Reviewed	January 2023

Description

This measure involves the installation of strip curtains on the main door of walk-in freezers and walk-in coolers. Strip curtains prevent infiltration of non-refrigerated air into refrigerated spaces when the main door is open for routine stocking activity. In the absence of strip curtains, the warmer, more humid air present in the store will infiltrate the unit, increasing the load of the refrigeration system and often reducing the efficiency of the evaporator unit as frost accumulates, impairing its effectiveness. The total refrigeration load due to infiltration through the main door into the unit depends on the temperature differential between the refrigerated and non-refrigerated space, the door area and height, and the duration and frequency of door openings. The avoided infiltration depends on the efficacy of the newly installed strip curtains as infiltration barriers. Algorithms and assumptions in this measure are drawn from a Strip Curtains measure maintained by the Northwest Regional Technical Forum (RTF), which calculates savings using the formulas outlined in ASHRAE's Refrigeration Handbook for calculating refrigeration load from infiltration by air exchange.

Baseline Case

The baseline case is a walk-in cooler or freezer that previously had either no strip curtain installed or on old ineffective strip curtain installed. The baseline condition efficiency is a walk-in cooler or freezer door with damaged or missing strip curtains in excess of 15% of the door area. The most likely areas of application are large and small grocery stores, supermarkets, restaurants, and refrigerated warehouses.

Efficient Case

The efficient equipment is a strip curtain added to a walk-in cooler or freezer. Strip curtains must be at least 0.06 inches thick. Low-temperature strip curtains must be used on low-temperature applications.

Annual Energy Savings Algorithms

Annual Electric Energy Savings

$$\Delta kWh = \frac{\Delta kWh}{ft^2} \times A$$

Annual Fuel Savings

$$\Delta Therms = N/A$$

Peak Demand Savings

$$\Delta kW_{Peak} = \frac{\Delta kWh}{ft^2} \times \frac{A}{Hrs}$$

Daily Peak Fuel Savings

$$\Delta Therms_{Peak} = N/A$$

Lifetime Energy Savings Algorithms

Lifetime Electric Energy Savings

$$\Delta kWh_{Life} = \Delta kWh \times EUL$$

Lifetime Fuel Savings

$$\Delta Therms_{Life} = N/A$$

Dual:

Lifetime Electric Energy Savings

$$\Delta kWh_{Life} = \Delta kWh_{EREP} \times RUL + \Delta kWh_{NR} \times EUL$$

Lifetime Fuel Savings

$$\Delta Therms_{Life} = N/A$$

Calculation Parameters

Table 3-279 Calculation Parameters

Variable	Description	Value	Units	Ref
ΔkWh	Annual electric energy savings	Calculated	kWh/yr	
ΔkW_{Peak}	Peak Demand Savings	Calculated	kW	
ΔkWh_{Life}	Lifetime electric energy savings	Calculated	kWh	
$\Delta kWh/ft^2$	Average annual kWh savings per square foot of insulation barrier	Look up in Table 3-280	kWh/ft ²	[125]
A	Doorway area	Site-specific, if unknown look up in Table 3-281	ft ²	[125]
Hrs	Annual hours of operation	Site-specific, if unknown use 8766	Hours	
CF	Electric coincidence factor	Look up in Table 3-282	N/A	
PDF	Gas peak demand factor	Look up in Table 3-282	N/A	
EUL	Effective useful life	See Measure Life Section	Years	

Variable	Description	Value	Units	Ref
RUL	Remaining useful life of existing unit	See Measure Life Section	Years	

Table 3-280 Default Annual Energy Savings for Strip Curtains per Square Foot

Type	Energy Savings for no pre-existing curtains, $\frac{\Delta kWh}{ft^2}$	Energy Savings for pre-existing curtains ¹³⁰ , $\frac{\Delta kWh}{ft^2}$
Grocery - Cooler	119.88	40.87
Grocery - Freezer	494.32	168.52
Convenience Store - Cooler	23.58	6.27
Convenience Store - Freezer	33.15	9.99
Restaurant - Cooler	22.50	6.19
Restaurant - Freezer	114.01	32.37
Refrigerated Warehouse - Cooler	153.36	53.42

Table 3-281 Doorway Area Assumptions

Type	Doorway Area, ft ²
Grocery - Cooler	21
Grocery - Freezer	21
Convenience Store - Cooler	21
Convenience Store - Freezer	21
Restaurant - Cooler	21
Restaurant - Freezer	21
Refrigerated Warehouse - Cooler	120

Peak Factors

Table 3-282 Peak Factors

Peak Factor	Value	Ref
Electric coincidence factor (CF)	1.0	
Natural gas peak day factor (PDF)	N/A	

¹³⁰ The In-Service-Rate (described as the Removal Rate by the RTF workbook) was changed from 25% to 0%. Additionally, a 58% efficacy value was inputted for sites that had existing, but inefficient strip curtains prior to retrofit [125]. This value is sourced from tracer gas measurements on over 100 walk-in refrigeration units during the California Public Utility Commission's (CPUC) evaluation of the 2006-2008 CA investor owned utility energy efficiency programs. The baseline curtain efficacy rates are taken from short-term monitoring of over 100 walk-in units. "Commercial Facilities Contract Group 2006-2008 Direct Impact Evaluation", CPUC, February 2010.

Measure Life

The remaining useful life (RUL) for existing equipment is limited to 1/3 of the effective useful life (EUL) of the equipment.

Table 3-283 Measure Life

Equipment	EUL	RUL	Ref
Strip Curtains	4	1.33	[126]

References

- [125] Database for UES Measures, Regional Technical Forum. Strip Curtains, version 3.0. April 2022.
<https://rtf.nwcouncil.org/measure/strip-curtains>
- [126] California Public Utilities Commission Database for Energy Efficient Resources (DEER) EUL Support Table for 2020, <http://www.deeresources.com/files/DEER2020/download/SupportTable-EUL2020.xlsx>. Accessed December 2018.

3.10.6 ANTI-SWEAT HEAT CONTROL

Market	Commercial
Baseline Condition	RF/DI
Baseline	Existing/Dual
End Use Subcategory	Refrigeration
Measure Last Reviewed	January 2023

Description

Anti-sweat door heaters (ASDH) prevent condensation on cooler and freezer doors. Anti-sweat heater (ASH) controls sense the humidity in the store outside of reach-in, glass door refrigerated cases and turn off anti-sweat heaters during periods of low humidity. Without controls, anti-sweat heaters run continuously whether they are necessary or not.

There are two commercially available control strategies – (1) ON/OFF controls and (2) micro pulse controls that respond to a call for heating, which is typically determined using either a door moisture sensor or an indoor air temperature and humidity sensor to calculate the dew point. In the first strategy, the ON/OFF controls turn the heaters on and off for minutes at a time, resulting in a reduction in run time. In the second strategy, the micro pulse controls pulse the door heaters for fractions of a second, in response to the call for heating. Savings are realized from the reduction in energy used by not having the heaters running at all times. In addition, secondary savings result from reduced cooling load on the refrigeration unit when the heaters are off.

Baseline Case

The baseline condition is assumed to be a commercial glass door cooler or refrigerator and freezer with a standard heated door running 24 hours a day, seven days per week (24/7), with no controls installed.

Efficient Case

The efficient equipment is assumed to be a door heater control on a commercial glass door cooler or refrigerator and freezer utilizing either ON/OFF or micro pulse controls.

Annual Energy Savings Algorithms

Annual Electric Energy Savings

$$\Delta kWh = kW_d \times (\%ON_b - \%ON_q) \times N \times Hrs \times IF_e$$

Annual Fuel Savings

$$\Delta Therms = N/A$$

Peak Demand Savings

$$\Delta kW_{Peak} = kW_d \times IF_e \times CF$$

Daily Peak Fuel Savings

$$\Delta Therms_{Peak} = N/A$$

Lifetime Energy Savings Algorithms

Lifetime Electric Energy Savings

$$\Delta kWh_{Life} = \Delta kWh \times EUL$$

Lifetime Fuel Savings

$$\Delta Therms_{Life} = N/A$$

Dual:

Lifetime Electric Energy Savings

$$\Delta kWh_{Life} = \Delta kWh_{EREP} \times RUL + \Delta kWh_{NR} \times EUL$$

Lifetime Fuel Savings

$$\Delta Therms_{Life} = N/A$$

Calculation Parameters

Table 3-284 Calculation Parameters

Variable	Description	Value	Units	Ref
ΔkWh	Annual electric energy savings	Calculated	kWh/yr	
ΔkW_{Peak}	Peak Demand Savings	Calculated	kW	
ΔkWh_{Life}	Lifetime electric energy savings	Calculated	kWh	
kW_d	Connected load kW per connected door	Site-specific, if unknown use 0.13	kW/door	[127]
N	Number of doors	Site-specific	N/A	
$\%ON_b$	Effective runtime of the uncontrolled ASDH	Site-specific, if unknown use 90.7%	N/A	[127]
$\%ON_q$	Effective runtime of the controlled ASDH	Look up in Table 3-285	N/A	[127]
IF_e	Interactive effects factor for energy to account for cooling savings from offset refrigeration load	Look up in Table 3-286	N/A	[127]
CF	Electric coincidence factor	Look up in Table 3-287	N/A	[127]
Hrs	Hours of operation	8,760	Hrs	

Variable	Description	Value	Units	Ref
EUL	Effective useful life	See Measure Life Section	Years	[128]

Table 3-285 Effective run time of controlled ASDH

Control Type	Value	Ref
ON/OFF control style	58.9%	[127]
Micropulse control style	42.8%	[127]
Unknown control style	45.6%	[127]

Table 3-286 Interactive effects factor for energy¹³¹

System Type	IF _e Value	Ref
Cooler or Refrigerator	1.26	[127]
Freezer	1.51	[127]

Coincidence Factor

Table 3-287 Coincidence Factors¹³²

Control Type	CF Value	Ref
ON/OFF control style	0.32	[127]
Micropulse control style	0.45	[127]
Unknown control style	0.44	[127]

Measure Life

The remaining useful life (RUL) for existing equipment is limited to 1/3 of the effective useful life (EUL) of the equipment.

Table 3-288 Measure Life

Equipment	EUL	RUL	Ref
Anti-sweat heat control	12	4	[128]

¹³¹ Interactive effects factor for energy is calculated by dividing the PJM Summer Peak kW equipment and interactive savings for ASDH by the equipment savings from Table 52 of the report reference [127].

¹³² Coincidence factors developed by dividing the PJM Summer Peak kW Savings for ASDH Controls from Table 52 of the reference [127] (0.057 kW/door for unknown control style, 0.041 kW/door for on/off controls, and 0.058 kW/door for micropulse controls) by the average wattage of ASDH per connected door (0.13 kW)

References

- [127] Commerical Refrigeration Loadshape Project, 2015 available at https://cadmusgroup.com/wp-content/uploads/2016/02/NEEP-CRL_Report_FINAL_clean.pdf?submissionGuid=cb214243-bab8-479a-a4c4-c8e5c64ae7b2
- [128] California Public Utilities Commission Database for Energy Efficient Resources (DEER) EUL Support Table for 2020 available at <http://www.deeresources.com/files/DEER2020/download/SupportTable-EUL2020.xlsx>

3.10.7 DEFROST CONTROLS

Market	Commercial
Baseline Condition	RF/DI
Baseline	Existing/Dual
End Use Subcategory	Control
Measure Last Reviewed	January 2023

Description

This measure is applicable to existing refrigerated cases, walk in freezers, and walk in coolers with a traditional electric defrost mechanism. This control system overrides defrost of evaporator coils when unnecessary, reducing annual energy consumption. The estimates for savings take into account savings from reduced number of defrost cycles as well as the reduction in heat gain from the defrost process.

Baseline Case

The baseline case is an electric defrost system that uses a time clock mechanism to initiate defrost.

Efficient Case

The high-efficiency case is a defrost system with electric defrost controls.

Annual Energy Savings Algorithms

Annual Electric Energy Savings

$$\Delta kWh = \Delta kWh_{Defrost} + \Delta kWh_{Heat}$$

Where,

$$\Delta kWh_{Defrost} = kW_{Defrost} \times Hours \times DRF$$

$$\Delta kWh_{Heat} = \Delta kWh_{Defrost} \times 0.28 \times Eff_{RS}$$

Annual Fuel Savings

$$\Delta Therms = N/A$$

Peak Demand Savings

$$\Delta kW_{Peak} = \frac{\Delta kWh}{8760} \times CF$$

Daily Peak Fuel Savings

$$\Delta Therms_{Peak} = N/A$$

Lifetime Energy Savings Algorithms

Lifetime Electric Energy Savings

$$\Delta kWh_{Life} = \Delta kWh \times EUL$$

Lifetime Fuel Savings

$$\Delta Therms_{Life} = N/A$$

Dual:

Lifetime Electric Energy Savings

$$\Delta kWh_{Life} = \Delta kWh_{EREP} \times RUL + \Delta kWh_{NR} \times EUL$$

Lifetime Fuel Savings

$$\Delta Therms_{Life} = N/A$$

Calculation Parameters

Table 3-289 Calculation Parameters

Variable	Description	Value	Units	Ref
ΔkWh	Annual electric energy savings	Calculated	kWh/yr	
ΔkW_{Peak}	Peak Demand Savings	Calculated	kW	
ΔkWh_{Life}	Lifetime electric energy savings	Calculated	kWh	
$\Delta kWh_{Defrost}$	Energy savings resulting from an increase in operating efficiency due to the addition of electronic defrost controls.	Calculated	kWh	
ΔkWh_{Heat}	Energy savings due to reduced heat from reduced number of defrost cycles	Calculated	kWh	
$kW_{Defrost}$	Load of electric defrost	Site-specific, if unknown use 0.9 kW	kW	
Hours	Number of hours defrost occurs over a year without the defrost controls	From Application, if unknown use 487 ¹³³	Hrs/yr	[131]
DRF	Defrost reduction factor- percent reduction in defrosts required per year	35%		[129]

¹³³ The refrigeration system is assumed to be in operation every day of the year, while savings from the evaporator coil defrost control will only occur during set defrost cycles. This is assumed to be (4) 20-minute cycles per day, for a total of 487 hours.

Variable	Description	Value	Units	Ref
Eff _{RS}	Efficiency of typical refrigeration system	From Application, if unknown 3.35 (cooler), 1.88 (freezer)	kW/ton	[132]
0.28	Conversion constant	0.28	ton/kW	
CF	Electric coincidence factor	Look up in Table 3-290	N/A	
PDF	Gas peak demand factor	Look up in Table 3-290	N/A	
EUL	Effective useful life	See Measure Life Section	Years	
RUL	Remaining useful life of existing unit	See Measure Life Section	Years	

Peak Factors

Table 3-290 Peak Factors

Peak Factor	Value	Ref
Electric coincidence factor (CF)	1	
Natural gas peak day factor (PDF)	N/A	

Measure Life

The remaining useful life (RUL) for existing equipment is limited to 1/3 of the effective useful life (EUL) of the equipment.

Table 3-291 Measure Life

Equipment	EUL	RUL	Ref
Defrost Controls	10	3.33	[130]

References

- [129] Supported by third party evaluation: Independent Testing was performed by Intertek Testing Service on a Walk-in Freezer that was retrofitted with Smart Electric Defrost capability
- [130] Vermont Technical Reference User Manual (TRM), March 16, 2015. Pg. 171. This is a conservative estimate is based on a discussion with Heatcraft based on the components expected life
- [131] Brian A. Fricke, Vishal Sharma, *Demand Defrost Strategies in Supermarket Refrigeration Systems*. (Oct 2011), Pg 2, <https://info.ornl.gov/sites/publications/files/pub31296.pdf>.
- [132] Naikaj Pandya and Jon Maxwell *X1931-5 PSD Commercial Refrigeration Efficiency Update Study* (EnergizeCT, 2022) https://energizect.com/sites/default/files/documents/CT%20x1931-5%20Commercial%20Refrigeration%20ACOP%20Final%20Report_051222.pdf

3.10.8 LED CASE LIGHTING

Market	Commercial
Baseline Condition	RF/DI
Baseline	Existing/Dual
End Use Subcategory	N/A
Measure Last Reviewed	January 2023

Description

This measure applies to the installation of LED lamps in vertical and horizontal display refrigerators, coolers, and freezers replacing T8 or T12 linear fluorescent lamps. Replacing fluorescent lamps with low heat generating LEDs reduces the energy consumption associated with the lighting components and reduces the amount of heat generated from the lamps that must be overcome through additional cooling.

Baseline Case

Existing T8 or T12 refrigerated case linear fluorescent lamps.

Efficient Case

DesignLights Consortium (DLC) version 5.1 qualified LED vertical or horizontal refrigerated case luminaires.

Annual Energy Savings Algorithms

Annual Electric Energy Savings

$$\Delta kWh = \left(\frac{W_b - W_q}{1,000} \right) \times units \times hrs \times \left(1 + (Eff_{comp} \times 0.284) \right)$$

Annual Fuel Savings

$$\Delta Therms = N/A$$

Peak Demand Savings

$$\Delta kW_{Peak} = \left(\frac{W_b - W_q}{1,000} \right) \times units \times CF \times \left(1 + (Eff_{comp} \times 0.284) \right)$$

Daily Peak Fuel Savings

$$\Delta Therms_{Peak} = N/A$$

Lifetime Energy Savings Algorithms

Lifetime Electric Energy Savings

$$\Delta kWh_{Life} = \Delta kWh \times EUL$$

Lifetime Fuel Savings

$$\Delta Therms_{Life} = N/A$$

Dual:

Lifetime Electric Energy Savings

$$\Delta kWh_{Life} = \Delta kWh_{REP} \times RUL + \Delta kWh_{NR} \times EUL$$

Lifetime Fuel Savings

$$\Delta Therms_{Life} = N/A$$

Calculation Parameters

Table 3-292 Calculation Parameters

Variable	Description	Value	Units	Ref
ΔkWh	Annual electric energy savings	Calculated	kWh/yr	
ΔkW_{Peak}	Peak Demand Savings	Calculated	kW	
ΔkWh_{Life}	Lifetime electric energy savings	Calculated	kWh	
W_b	Rated baseline fixture wattage	Site-specific, if unknown: T8 Case Lighting System = 15.2/Linear Feet T12HO Case Lighting System = 18.7/Linear Feet	Watts	[137]
W_q	Rated energy efficient wattage	Site-specific	Watts	
Units	Number of LED fixtures installed under the program	Site-specific	N/A	
Hrs	Hours of use	Site-specific, if unknown assume 6,205	Hrs/yr	[133]
Eff_{comp}	Compressor efficiency	Site-specific, if unknown look up in Table 3-293	kW/ton	[134]
0.284	Conversion factor from kW to tons of refrigeration	0.284	Tons/kW	
CF	Electric coincidence factor	Look up in Table 3-294	N/A	
PDF	Gas peak demand factor	Look up in Table 3-294	N/A	
EUL	Effective useful life	See Measure Life Section	Years	
RUL	Remaining useful life of existing unit	See Measure Life Section	Years	

Table 3-293 Compressor Efficiency

Case Type	Eff _{comp}
Cooler	1.00
Freezer	1.92

Peak Factors**Table 3-294 Peak Factors**

Peak Factor	Value	Ref
Electric coincidence factor (CF)	0.92	[135]
Natural gas peak day factor (PDF)	N/A	

Measure Life

The effective useful life (EUL) is smaller of the measure EUL (16 years [136]) and the case RUL.

References

- [133] Theobald, M. A., Emerging Technologies Program: Application Assessment Report #0608, LED Supermarket Case Lighting Grocery Store, Northern California, Pacific Gas and Electric Company, January 2006. Assumes refrigerated case lighting typically operates 17 hours per day, 365 days per year.
- [134] Based on CDH Energy evaluation of actual refrigeration system performance for several commercially available compressors, dated 09/06/2017. Values presented reflect average efficiencies of R22 systems.
- [135] Pennsylvania PUC, Technical Reference Manual, June 2016, p. 258.
- [136] DEER 2014 EUL ID: GrocDisp-FixtLtg-LED
- [137] Pacific Gas & Electric. May 2007. LED Refrigeration Case Lighting Workpaper 053007 rev1. Values normalized on a per linear foot basis.

3.10.9 REFRIGERATED CASE LIGHT OCCUPANCY SENSORS

Market	Commercial
Baseline Condition	RF/DI
Baseline	Existing/Dual
End Use Subcategory	Control
Measure Last Reviewed	January 2023

Description

This measure documents the energy savings attributed to installing occupancy sensors to control LED refrigerated case lighting. Energy savings can be achieved from the installation of sensors that dim or turn off the lights when the space or aisle is unoccupied. Energy savings result from a combination of reduced lighting energy and reduced cooling load within the case.

Baseline Case

No motion-based controls.

Efficient Case

This measure requires the installation of motion-based lighting controls that allow the LED case lighting to be dimmed or turned off completely during unoccupied conditions.

Annual Energy Savings Algorithms

Annual Electric Energy Savings

$$\Delta kWh = \frac{W}{1,000} \times Hrs \times RRF \times (1 + IF_e)$$

Annual Fuel Savings

$$\Delta Therms = N/A$$

Peak Demand Savings

$$\Delta kW_{peak} = N/A$$

There are no peak demand savings associated, as the savings are assumed to occur off-peak.

Daily Peak Fuel Savings

$$\Delta Therms_{peak} = N/A$$

Lifetime Energy Savings Algorithms

Lifetime Electric Energy Savings

$$\Delta kWh_{Life} = \Delta kWh \times EUL$$

Lifetime Fuel Savings

$$\Delta Therms_{Life} = N/A$$

Dual:

Lifetime Electric Energy Savings

$$\Delta kWh_{Life} = \Delta kWh_{EREP} \times RUL + \Delta kWh_{NR} \times EUL$$

Lifetime Fuel Savings

$$\Delta Therms_{Life} = \Delta Therms_{EREP} \times RUL + \Delta Therms_{NR} \times EUL$$

Calculation Parameters

Table 3-295 Calculation Parameters

Variable	Description	Value	Units	Ref
ΔkWh	Annual electric energy savings	Calculated	kWh/yr	
ΔkW_{Peak}	Peak Demand Savings	Calculated	kW	
ΔkWh_{Life}	Lifetime electric energy savings	Calculated	kWh	
W	Connected wattage of controlled refrigerated lighting fixtures	Site-specific	Watts	
Hrs	Annual operating hours	Site-specific. If unknown assume 6,205	Hours	[138]
IF_e	Interactive effects factor for energy to account for colling savings from offset refrigeration load	Lookup in Table 3-296	N/A	[139]
RRF	Runtime reduction factor	Lookup in Table 3-297	N/A	[140]
1,000	Conversion factor	1,000	W/kW	
CF	Electric coincidence factor	Lookup in Table 3-298	N/A	
PDF	Gas peak day factor	Lookup in Table 3-298	N/A	
EUL	Effective useful life	See Measure Life Section	Years	

Table 3-296 Interactive Effects Factor

Refrigerator and Cooler	Freezer
0.29	0.50

Table 3-297 Runtime Reduction Factor

24 Hour Facility	18 Hour Facility
0.39	0.29

Peak Factors

Table 3-298 Peak Factors

Peak Factor	Value	Ref
Electric coincidence factor (CF)	N/A	
Natural gas peak day factor (PDF)	N/A	

Measure Life

The remaining useful life (RUL) for existing equipment is limited to 1/3 of the effective useful life (EUL) of the equipment.

Table 3-299 Measure Life

Equipment	EUL	RUL	Ref
Refrigerated Case Lighting	8	2.66	[141]

References

- [138] Matteson, Mary, Marc Senior, and Energy Analyst. n.d. *Pacific Gas and Electric Company Emerging Technologies Program Application Assessment Report #0608 LED Supermarket Case Lighting Grocery Store, Northern California Pacific Gas and Electric Company*. Assumes 6,205 annual operating hours and 50,000 lifetime hours. Most case lighting runs continuously (24/7) but some can be controlled. 6,205 annual hours of use can be used to represent the mix. Using grocery store hours of use (4,660 hr) is too conservative since case lighting is not tied to store lighting. https://www.etcc-ca.com/sites/default/files/OLD/images/stories/pdf/ETCC_Report_204.pdf
- [139] 2021 Pennsylvania TRM, Volume 3, Commercial and Industrial Measures. Table 3 8: Interactive Factors for All Bulb Types. <https://www.puc.pa.gov/pdocs/1692532.docx>
- [140] "ComGroceryDisplayCaseMotionSensors_v3_3.Xlsm | Powered by Box." n.d. Nwcouncil.app.box.com. Accessed January 20, 2023. <https://nwcouncil.app.box.com/s/brl01usbhvxtrjbp0i2xcqk016lndfd1>
- [141] California Public Utilities Commission Database for Energy Efficient Resources (DEER) EUL Support Table for 2020. <http://www.deeresources.com/files/DEER2020/download/SupportTable-EUL2020.xlsx>

3.10.10 EVAPORATOR FAN EC MOTOR

Market	Commercial
Baseline Condition	RF/DI
Baseline	Existing/Dual
End Use Subcategory	Control
Measure Last Reviewed	January 2023

Description

This measure covers energy and demand savings associated with the replacement of existing shaded-pole (SP) evaporator fan motors or Permanent Split Capacitor (PSC) motors in refrigerated cases with an Electronically Commutated motor (ECM) or a Permanent Magnet Synchronous (PMS) motor. The baseline condition assumes the evaporator fan motor is uncontrolled (i.e., it runs continuously). This measure applies to equipment manufactured before January 1, 2009 only, as the Code of Federal Regulations requires the use of EC or three-phase motors in evaporator fans in equipment manufactured on or after that date. Savings are calculated per motor replaced.

There are two sources of energy and demand savings through this measure:

- 1) The direct savings associated with replacement of an inefficient motor with a more efficient one;
- 2) The indirect savings of a reduced cooling load on the refrigeration unit due to less heat gain from the more efficient evaporator fan motor in the air-stream.

Baseline Case

The baseline case is a walk-in cooler/freezer or refrigerated display case with shaded pole (SP) or permanent split capacitor (PSC) evaporator fan motors.

Efficient Case

The efficient case is a walk-in cooler/freezer or refrigerated display case with Permanent Magnet Synchronous (PMS) motor or electronically commutated evaporator fan motors (ECM) with full load efficiency exceeding that prescribed by federal energy conservation standards for electric motors in 10 CFR 431.446 and/or 10 CFR 431.25 as applicable.

Annual Energy Savings Algorithms

Annual Electric Energy Savings

$$\Delta kWh = (kW_b - kW_q) \times F_{uncontrolled} \times 8,760 \times IF_e$$

If motor power is unknown, calculate using the algorithms below:

$$kW_b = HP_b \times \frac{0.746}{Eff_b} \times LF$$

$$kW_q = HP_q \times \frac{0.746}{Eff_q} \times LF$$

Annual Fuel Savings

$$\Delta Therms = N/A$$

Peak Demand Savings

$$\Delta kW_{Peak} = \frac{\Delta kWh}{8,760}$$

Daily Peak Fuel Savings

$$\Delta Therms_{Peak} = N/A$$

Lifetime Energy Savings Algorithms

Lifetime Electric Energy Savings

$$\Delta kWh_{Life} = \Delta kWh \times EUL$$

Lifetime Fuel Savings

$$\Delta Therms_{Life} = N/A$$

Dual:

Lifetime Electric Energy Savings

$$\Delta kWh_{Life} = \Delta kWh_{EREP} \times RUL + \Delta kWh_{NR} \times EUL$$

Lifetime Fuel Savings

$$\Delta Therms_{Life} = N/A$$

Calculation Parameters

Table 3-300 Calculation Parameters

Variable	Description	Value	Units	Ref
ΔkWh	Annual electric energy savings	Calculated	kWh/yr	
ΔkW_{Peak}	Peak Demand Savings	Calculated	kW	
ΔkWh_{Life}	Lifetime electric energy savings	Calculated	kWh	
kW_b	Input wattage of the baseline motor	Site-specific, if unknown, calculated from motor HP	kW	
kW_q	Input wattage of the efficient motor	Site-specific, if unknown, calculated from motor HP	kW	

Variable	Description	Value	Units	Ref
$F_{\text{uncontrolled}}$	Effective runtime fraction of the uncontrolled motor	Site-specific, if unknown, use 0.978	N/A	[142]
HP_b	Rated horsepower of the baseline motor	Site-specific, if unknown use 1/15 HP	HP	
HP_q	Rated horsepower of the efficient motor	Site-specific	HP	
LF	Load factor	Site-specific ¹³⁴ , if unknown, use 0.9		[144]
IF_e	Interactive effects factor for energy to account for cooling savings from offset refrigeration load	Look up in Table 3-301	N/A	[142]
8,760	Annual operating hours of Evaporator Fan	8,760	hours	
0.746	Unit conversion, kW/HP	0.746	kW/HP	
Eff_b	Efficiency of the baseline motor	SP: 30% PSC: 60%	N/A	[143]
Eff_q	Efficiency of the qualifying motor	ECM: 70% PMS: 73%	N/A	[143]
CF	Electric coincidence factor	Look up in Table 3-302	N/A	
PDF	Gas peak day factor	Look up in Table 3-302	N/A	
EUL	Effective useful life	See Measure Life Section	Years	

Table 3-301 Interactive Factor for Energy

Equipment Type	IF_e Value
SP Base, Cooler	0.38
PSC Base, Cooler	0.19
SP Base, Freezer	0.76
PSC Base, Freezer	0.38

Peak Factors

Table 3-302 Peak Factors

Peak Factor	Value	Ref
Electric coincidence factor (CF)	1.0	
Natural gas peak day factor (PDF)	N/A	

¹³⁴ Load Factor is the ratio between the actual load and rated load. This can be estimated by spot metering and nameplate reading.

Measure Life

The effective useful life (EUL) is smaller of the RUL of the host equipment or 16 years [145].

References

- [142] Cadmus, *Commercial Refrigeration Loadshape Project* (2015). https://cadmusgroup.com/wp-content/uploads/2016/02/NEEP-CRL_Report_FINAL_clean.pdf
- [143] Department of Energy. “Energy Savings Potential and Opportunities for High-Efficiency Electric Motors in Residential and Commercial Equipment.” December 2013. Motor efficiencies for the baseline motors are drawn from Table 2.1, which provides peak efficiency ranges for a variety of motors. The motor efficiency for an ECM is drawn from the discussion in 2.4.3.
<https://www.energy.gov/sites/prod/files/2014/02/f8/Motor%20Energy%20Savings%20Potential%20Report%20013-12-4.pdf>
- [144] *New York Standard Approach for Estimating Energy Savings from Energy Efficiency Programs – Residential Multifamily, and Commercial/Industrial Measures. Version 6.* (April 16, 2018)
- [145] California Public Utilities Commission Database for Energy Efficient Resources (DEER) EUL Support Table for 2020, <http://www.deeresources.com/files/DEER2020/download/SupportTable-EUL2020.xlsx>

3.10.11 EVAPORATOR FAN CONTROLLER

Market	Commercial
Baseline Condition	RF/DI
Baseline	Existing/Dual
End Use Subcategory	Control
Measure Last Reviewed	January 2023

Description

This measure is for the installation of evaporator fan controls in walk-in refrigerators or freezers with no pre-existing controls. An evaporator fan controller is a device or system that lowers airflow across an evaporator when there is no refrigerant flow through the evaporator (i.e., when the compressor is in an off-cycle). Evaporator fans run constantly to provide cooling when the compressor is running, and to provide air circulation when the compressor is not running. There are two commercially available strategies – ON/OFF controls and multispeed controls – that respond to a call for cooling. In the first strategy, the ON/OFF controls turn the motors on and off in response to the call for cooling, generating energy and demand savings as a result of a reduction in run time. In the second strategy, the multispeed controls change the speed of the motors in response to the call for cooling, saving energy and reducing demand by reducing operating power and run time (multispeed controls can also turn the motor off).

A fan controller saves energy by reducing fan usage, by reducing the refrigeration load resulting from the heat given off by the fan and by reducing compressor energy resulting from the electronic temperature control. This measure documents the energy savings attributed to evaporator fan controls.

Baseline Case

The baseline case is assumed to be a shaded pole (SP) motor or PSC motor in walk-in evaporators without controls or an electronically-commutated motor (ECM) without controls.

Efficient Case

The efficient equipment is assumed to be an evaporator fan powered by an ECM, SP or PSC motor utilizing either ON/OFF or multispeed controls.

Annual Energy Savings Algorithms

Annual Electric Energy Savings

$$\Delta kWh = kW \times (\%ON_b - \%ON_q) \times Hrs \times IF_e$$

Where,

$$kW = HP \times LF \times 0.746/\eta$$

Annual Fuel Savings

$$\Delta Therms = N/A$$

Peak Demand Savings

$$\Delta kW_{Peak} = \frac{\Delta kWh}{Hrs} \times CF$$

Daily Peak Fuel Savings

$$\Delta Therms_{Peak} = N/A$$

Lifetime Energy Savings Algorithms

Lifetime Electric Energy Savings

$$\Delta kWh_{Life} = \Delta kWh \times EUL$$

Lifetime Fuel Savings

$$\Delta Therms_{Life} = N/A$$

Dual:

Lifetime Electric Energy Savings

$$\Delta kWh_{Life} = \Delta kWh_{EREP} \times RUL + \Delta kWh_{NR} \times EUL$$

Lifetime Fuel Savings

$$\Delta Therms_{Life} = N/A$$

Calculation Parameters

Table 3-303 Calculation Parameters

Variable	Description	Value	Units	Ref
ΔkWh	Annual electric energy savings	Calculated	kWh/yr	
ΔkW_{Peak}	Peak Demand Savings	Calculated	kW	
ΔkWh_{Life}	Lifetime electric energy savings	Calculated	kWh	
kW	Input wattage of the SP, PSC or ECM motor	Site-specific, if unknown calculated	kW	
0.746	Conversion factor	0.746	kW/HP	[148]
LF	Load Factor - Ratio between the actual load and the rated load.	Site-specific, if unknown use 0.9	N/A	[148]
HP	Horsepower of SP, PSC or ECM motor	Site-specific	HP	

Variable	Description	Value	Units	Ref
η	Motor efficiency of the SP, PSC or ECM motor	SP: 30% PSC: 60% ECM: 70%		[149]
%ON _b	Effective runtime of the uncontrolled motor	Site-specific, if unknown use 97.8%	N/A	[146]
%ON _q	Effective runtime of the controlled motor	Site-specific, if unknown look up in Table 3-304	N/A	[146]
IF _e	Interactive effects factor for energy to account for cooling savings from offset refrigeration load	Look up in Table 3-305	N/A	[146]
CF	Electric coincidence factor	Look up in Table 3-306	N/A	[146]
Hrs	Hours of operation	8,760	Hrs	
EUL	Effective useful life	See Measure Life Section	Years	

Table 3-304 Effective run time of controlled motors

Control Type	Value	Ref
ON/OFF style controls	63.6%	[146]
Multi-speed style controls	69.2%	[146]

Table 3-305 Interactive Effects Factor for Energy¹³⁵

System Type	IF _e Value	Ref
Cooler or Refrigerator	1.38	[146]
Freezer	1.76	[146]

Coincidence Factor

Table 3-306 Coincidence Factors¹³⁶

Control Type	CF Value	Ref
ON/OFF control style	0.087	[146]
Micropulse control style	0.102	[146]
Unknown control style	0.094	[146]

¹³⁵ Interactive effects factor for energy is calculated by dividing the annual energy savings (kWh/HP) for "Equipment and Interactive" (shown in Table 43 of the reference [127]) by annual energy savings (kWh/HP) for the "Equipment Only" equipment type (also shown in Table 43).

¹³⁶ Coincidence factors are developed by dividing the PJM summer peak kW/HP savings for evaporator fan controls (shown in Table 47 of the report reference [127]) by the average annual energy savings (kWh/HP) for evaporator fan controls (shown in Table 43 of the report reference [127]).

Measure Life

The effective useful life (EUL) is smaller of the RUL of the host equipment or 16 years [147].

References

- [146] Commercial Refrigeration Loadshape Project, 2015 available at https://cadmusgroup.com/wp-content/uploads/2016/02/NEEP-CRL_Report_FINAL_clean.pdf?submissionGuid=cb214243-bab8-479a-a4c4-c8e5c64ae7b2
- [147] California Public Utilities Commission Database for Energy Efficient Resources (DEER) EUL Support Table for 2020 available at <http://www.deeresources.com/files/DEER2020/download/SupportTable-EUL2020.xlsx>
- [148] DNV KEMA (2013). *Impact Evaluation of 2010 Prescriptive Lighting Installations. Prepared for Massachusetts Energy Efficiency Program Administrators and Massachusetts Energy Efficiency Advisory*
- [149] Department of Energy. "Energy Savings Potential and Opportunities for High-Efficiency Electric Motors in Residential and Commercial Equipment." December 2013. Motor efficiency for SP motors is drawn from Table 2.1, which provides peak efficiency ranges for a variety of motors. The motor efficiency for an ECM is drawn from the discussion in 2.4.3.
<https://www.energy.gov/sites/prod/files/2014/02/f8/Motor%20Energy%20Savings%20Potential%20Report%2013-12-4.pdf>

3.10.12 FLOATING HEAD PRESSURE CONTROL

Market	Commerical
Baseline Condition	RF
Baseline	Existing
End Use Subcategory	Control
Measure Last Reviewed	January 2023

Description

Installers conventionally design a refrigeration system to condense at a set pressure-temperature point, typically 90°F. By installing a floating head pressure control (FHPCs) condenser system, the refrigeration system can change condensing temperatures in response to different outdoor temperatures. This means that the minimum condensing head pressure from a fixed setting (180 psig for R-22) is lowered to a saturated pressure equivalent at 70°F or less. Reduced head pressure improves the compressor efficiency at the expense of additional condenser fan power, with a net overall decrease in the compressor plus condenser fan power. Either a balanced-port or electronic expansion valve that is sized to meet the load requirement at a 70°F condensing temperature must be installed. Alternatively, a device may be installed to supplement the refrigeration feed to each evaporator attached to a condenser that is reducing head pressure.

Baseline Case

The baseline case is a refrigeration system without FHPC.

Efficient Case

The efficient case is a refrigeration system with FHPC.

Annual Energy Savings Algorithms

Annual Electric Energy Savings

$$\Delta kWh = HP_{compressor} \times \frac{kWh}{HP}$$

If the refrigeration system is rated in tonnage:

$$\Delta kWh = \frac{4.715}{COP} \times Tons \times \frac{kWh}{HP}$$

Annual Fuel Savings

$$\Delta Therms = N/A$$

Peak Demand Savings

$$\Delta kW_{Peak} = 0$$

Daily Peak Fuel Savings

$$\Delta Therms_{Peak} = N/A$$

Lifetime Energy Savings Algorithms

Lifetime Electric Energy Savings

$$\Delta kWh_{Life} = \Delta kWh \times EUL$$

Lifetime Fuel Savings

$$\Delta Therms_{Life} = N/A$$

Calculation Parameters

Table 3-307 Calculation Parameters

Variable	Description	Value	Units	Ref
ΔkWh	Annual electric energy savings	Calculated	kWh/yr	
ΔkW_{Peak}	Peak Demand Savings	Calculated	kW	
ΔkWh_{Life}	Lifetime electric energy savings	Calculated	kWh	
$HP_{compressor}$	Rated horsepower per compressor	Site-specific	HP	
Tons	Refrigerator tonnage of the system	Site-specific	ton	
kWh/HP	Annual Savings per HP	Look up in Table 3-308	kWh/HP	[150][153]
COP	Coefficient of Performance	Look up in Table 3-309	N/A	[150][152]
4.715	Unit Conversion, HP/ton	4.715	HP/ton	
CF	Electric coincidence factor	Look up in Table 3-310	N/A	
PDF	Gas peak demand factor	Look up in Table 3-310	N/A	
EUL	Effective useful life	See Measure Life Section	Years	

Annual Savings per HP

Table 3-308 Annual Savings per HP

System Type/Size	kWh/hp
Unitary Condenser, Low Temp, 0-3 hp	252.03

System Type/Size	kWh/hp
Unitary Condenser, Low Temp, >3-6 hp	241.86
Unitary Condenser, Low Temp, >6-10 hp	248.68
Unitary Condenser, Low Temp, >10 hp	282.24
Unitary Condenser, Medium Temp, 0-3 hp	131.45
Unitary Condenser, Medium Temp, >3-6 hp	127.32
Unitary Condenser, Medium Temp, >6-10 hp	128.1
Unitary Condenser, Medium Temp, >10 hp	132.58
Remote Condenser, Low Temp, 0-3 hp	505.37
Remote Condenser, Low Temp, >3-6 hp	481.06
Remote Condenser, Low Temp, >6-10 hp	484.96
Remote Condenser, Low Temp, >10 hp	503.32
Remote Condenser, Medium Temp, 0-3 hp	393.38
Remote Condenser, Medium Temp, >3-6 hp	387.53
Remote Condenser, Medium Temp, >6-10 hp	396.89
Remote Condenser, Medium Temp, >10 hp	404.66

Table 3-309 COP for refrigeration equipment

System Type	Freezer (Low Temp)	Refrigerator (Medium Temp)	Ref
Unitary Condenser	1.4	2.6	[150]
Remote Condenser	1.88	3.35	[152]

Peak Factors

Table 3-310 Peak Factors

Peak Factor	Value	Ref
Electric coincidence factor (CF)	N/A	
Natural gas peak day factor (PDF)	See Appendix G: Natural Gas Peak Day Factors	

Measure Life

The effective useful life (EUL) is 15 years [151] or one-third of the EUL of the host equipment.

References

- [150] Regional Technical Forum (RTF) as part of the Northwest Power & Conservation Council, Commercial Grocery Floating Head Pressure Controls Single Compressor v3.0, April 18, 2022; available at <https://rtf.nwcouncil.org/measure/floating-head-pressure-controls-single-compressor-systems/>
Assumed the kWh/hp savings for NJ will be equivalent to the kWh/hp savings derived for NYC location.
- [151] California Public Utilities Commission Database for Energy Efficient Resources (DEER) EUL Support Table for 2020 available at <http://www.deeresources.com/files/DEER2020/download/SupportTable-EUL2020.xlsx>
- [152] DNV. 2022. "X1931-5 PSD Commercial Refrigeration Efficiency Update Study." Connecticut Energy Efficiency Board.
- [153] New York Standard Approach for Estimating Energy Savings from Energy Efficiency Programs (TRM), Version 10, January 2023 available at <https://www3.dps.ny.gov/W/PSCWeb.nsf/PFPage/72C23DECF52920A85257F1100671BDD?OpenDocument>

3.10.13 VFD COMPRESSOR

Market	Commercial
Baseline Condition	RF/DI
Baseline	Existing/Dual
End Use Subcategory	Refrigeration
Measure Last Reviewed	January 2023

Description

Variable frequency drive (VFD) compressors are used to control and reduce the speed of the compressor during times when the refrigeration system does not require the motor to run at full capacity. VFD control is an economical and efficient retrofit option for existing compressor installations. The performance of variable speed compressors can more closely match the variable refrigeration load requirements thus minimizing energy consumption.

Baseline Case

Existing rotary screw compressor with slide valve control system.

Efficient Case

Rotary screw compressor with VFD control system.

Annual Energy Savings Algorithms

Annual Electric Energy Savings

$$\Delta kWh = 0.212 \times \frac{1}{COP} \times HP_{compressor} \times ES_{value}$$

Annual Fuel Savings

$$\Delta Therms = N/A$$

Peak Demand Savings

$$\Delta kW_{Peak} = 0.212 \times \frac{1}{COP} \times HP_{compressor} \times DS_{value} \times CF$$

Daily Peak Fuel Savings

$$\Delta Therms_{Peak} = N/A$$

Lifetime Energy Savings Algorithms

Lifetime Electric Energy Savings

$$\Delta kWh_{Life} = \Delta kWh \times EUL$$

Lifetime Fuel Savings

$$\Delta Therms_{Life} = N/A$$

Dual:

Lifetime Electric Energy Savings

$$\Delta kWh_{Life} = \Delta kWh_{EREP} \times RUL + \Delta kWh_{NR} \times EUL$$

Lifetime Fuel Savings

$$\Delta Therms_{Life} = N/A$$

Calculation Parameters

Table 3-311 Calculation Parameters

Variable	Description	Value	Units	Ref
ΔkWh	Annual electric energy savings	Calculated	kWh/yr	
ΔkW_{Peak}	Peak Demand Savings	Calculated	kW	
ΔkWh_{Life}	Lifetime electric energy savings	Calculated	kWh	
$HP_{compressor}$	Rated horsepower per compressor	Site-specific	hp	
ES_{value}	Energy savings value	1,696	kWh/ton	[154]
DS_{value}	Demand savings value	0.22	Kw/ton	[154]
COP	Coefficient of performance	Site-specific, if unknown look up in Table 3-312	N/A	[155]
0.212	Conversion factor from HP to ton	0.212	Ton/hp	
CF	Electric coincidence factor	Look up in Table 3-313	N/A	
PDF	Gas peak demand factor	Look up in Table 3-313	N/A	
EUL	Effective useful life	See Measure Life Section	Years	
RUL	Remaining useful life of existing unit	See Measure Life Section	Years	

Table 3-312 COP for refrigeration equipment

Equipment	COP
Coolers	3.35

Equipment	COP
Freezers	1.88

Peak Factors

Table 3-313 Peak Factors

Peak Factor	Value	Ref
Electric coincidence factor (CF)	1	
Natural gas peak day factor (PDF)	N/A	

Measure Life

The effective useful life (EUL) is smaller of the RUL of the host rotary screw compressor or 15 years [156].

References

- [154] 2005 DEER (Database for Energy Efficiency Resources). This measure considered the associated savings by vintage and by climate zone for compressors. The deemed value was an average across all climate zones and all vintages (excluding new construction). <http://www.deeresources.com/index.php/deer2005>
- [155] Connecticut Energy Efficiency Board (EEB) “PSD Commercial Refrigeration Efficiency Update Study”, May 2022
https://energizect.com/sites/default/files/documents/CT%20x1931-5%20Commercial%20Refrigeration%20ACOP%20Final%20Report_051222.pdf
- [156] California Public Utilities Commission Database for Energy Efficient Resources (DEER) EUL Support Table for 2020 available at <http://www.deeresources.com/files/DEER2020/download/SupportTable-EUL2020.xlsx>

3.11 WATER HEATING

3.11.1 STORAGE WATER HEATER

Market	Commercial
Baseline Condition	NC/TOS/EREP
Baseline	Code/Existing/Dual
End Use Subcategory	Equipment
Measure Last Reviewed	January 2023

Description

This measure covers the installation of gas and electric storage tank water heaters designed to heat and store water at a thermostatically controlled temperature. This measure applies to potable hot water delivery only; it is not applicable to hot water heaters used for process loads or space heating.

Storage type units include commercial gas-fired storage water heaters with a nominal input of greater than 75,000 BTU/h and less than 4,000 BTU/h per gallon of stored water, and commercial electric storage water heaters with a nominal input of greater than 12 kilowatts and less than 4,000 BTU/h per gallon of stored water.

This measure applies to replacement of existing storage type water heaters using the same heating as the efficient case. For new construction, this measure assumes baseline to be a standard efficiency water heater using the same heating fuel as the efficient equipment.

This measure applies to commercial grade water heaters only. For residential-duty water heaters installed in commercial settings, the Residential Storage Tank and Instantaneous Domestic Water Heater methodology detailed in this document shall be employed utilizing typical GPD values as defined in the “Gallons per Day (GPD)” section below.

Baseline Case

New Construction, Time of Sale:

The baseline condition for replacement measures is a standard efficiency fossil fuel or electric storage type water heater (based on proposed conditions) with tank volume and input capacity equivalent to the efficient case, UA value calculated as prescribed in the savings algorithm and a thermal efficiency of 0.80 (fossil fuel) or 0.98 (electric).

Early Replacement

The baseline condition for the Early Replacement measure is the existing water heater for the remaining useful life of the unit, and then for the remainder of the measure life the baseline becomes a new replacement unit meeting the minimum federal efficiency standard.

Efficient Case

The compliance condition is a fossil fuel or electric storage type water heater as defined in the Measure Description section above, which exceeds the efficiency of the baseline equipment.

Annual Energy Savings Algorithms

Annual Electric Energy Savings

$$\Delta kWh_{NR} = \frac{GPD \times 365 \times 8.33 \times \Delta T_{main}}{3,412} \times \left(\frac{1}{E_{t,b}} - \frac{1}{E_{t,q}} \right) + \left(\frac{UA_b}{E_{t,b}} - \frac{UA_q}{E_{t,q}} \right) \times \frac{\Delta T_{amb} \times 8,760}{3412}$$

Where,

$$\Delta T_{main} = T_{set} - T_{main}$$

$$UA_q = \frac{SL_q}{70}$$

$$UA_b = \frac{SL_b}{70}$$

For baseline of large electric storage type water heaters (> 12kW and > 20 gallons):

$$SL_b = \frac{\left(0.3 + \frac{27}{v_b}\right)}{100} \times 70 \times v_b \times 8.33$$

For baseline of large oil and gas storage type water heaters (> 75,000 BTU/h input capacity (Q) and storage size > 1 gallon per 4000 BTU/h):

$$SL_b = \frac{Q_b}{800} + 110\sqrt{v_b}$$

Annual Fuel Savings

$$\Delta Therms_{NR} = \frac{GPD \times 365 \times 8.33 \times \Delta T_{main}}{100000} \times \left(\frac{1}{E_{t,b}} - \frac{1}{E_{t,q}} \right) + \left(\frac{UA_b}{E_{t,b}} - \frac{UA_q}{E_{t,q}} \right) \times \frac{\Delta T_{amb} \times 8,760}{100000}$$

Peak Demand Savings

$$\Delta kW_{Peak} = \frac{\Delta kWh}{8,760} \times CF$$

Daily Peak Fuel Savings

$$\Delta Therms_{Peak} = \Delta Therms \times PDF$$

Lifetime Energy Savings Algorithms

Lifetime Electric Energy Savings

No dual baseline:

$$\Delta kWh_{Life} = \Delta kWh \times EUL$$

Dual baseline:

$$\Delta kWh_{Life} = (\Delta kWh \text{ using existing baseline}) \times RUL + (\Delta kWh \text{ using code baseline}) \times (EUL - RUL)$$

Lifetime Fuel Energy Savings

No dual baseline:

$$\Delta Therms_{Life} = \Delta Therms \times EUL$$

Dual baseline:

$$\Delta Therms_{Life} = (\Delta Therms \text{ using existing baseline}) \times RUL + (\Delta Therms \text{ using code baseline}) \times (EUL - RUL)$$

Calculation Parameters

Table 3-314 Calculation Parameters

Variable	Description	Value	Units	Ref
ΔkWh	Annual electric energy savings	Calculated	kWh/yr	
$\Delta Therms$	Annual fuel savings	Calculated	Therms/yr	
ΔkW_{Peak}	Peak Demand Savings	Calculated	kW	
$\Delta Therms_{Peak}$	Daily peak fuel savings	Calculated	Therms/day	
ΔkWh_{Life}	Lifetime electric energy savings	Calculated	kWh	
$\Delta Therms_{Life}$	Lifetime fuel savings	Calculated	Therms	
ΔT_{main}	Average temperature difference between water heater set point temperature and the supply water temperature in water main	Calculated	°F	
ΔT_{amb}	Average temperature difference between water heater set point temperature and the surrounding ambient air temperature	Calculated	°F	
UA_b	Overall heat loss coefficient of the baseline condition	Calculated	Btu/h-°F	
GPD	Gallons per day	Site Specific, if unknown look up in Table 3-315	Gal/day	[167][168][169][170]
UA_q	Overall heat loss coefficient of the energy efficient measure	Site-specific	Btu/h-°F	
SL_b	Standby loss of baseline unit	Code baseline: calculated Existing baseline: site-specific, calculated if unknown		
SL_q	Standby loss of efficient unit from AHRI rating	Site-specific		

Variable	Description	Value	Units	Ref
T_{set}	Water heater set point temperature	Site Specific, if unknown use 140	°F	[161]
$E_{t,b}$	Thermal efficiency of the baseline condition	Code baseline: Look up in Table 3-316 Existing baseline: Site-specific. If unknown, use code based on equipment age.	N/A	[229][344]
$E_{t,q}$	Thermal efficiency of the energy efficient condition	Site-specific	N/A	
v_b	Baseline tank volume, equal to the storage capacity of the efficient equipment	Site-specific	gal	
Q_b	Baseline input capacity, equal to the input capacity of the efficient equipment	Site-specific	Btu/hr	
T_{main}	Supply water temperature in water main ¹³⁷	60	°F	[223]
T_{amb}	Surrounding ambient air temperature	70	°F	[162]
365	Days per year	365	Days/yr	
3,412	Conversion factor	3,412	Btu/kWh	
8.33	Energy required (Btu) to heat one gallon of water by one degree Fahrenheit	8.33	Btu/gal°F	
100,000	Conversion factor	100,000	Btu/therm	
CF	Electric coincidence factor	Look up in Table 3-317	N/A	
PDF	Gas peak day factor	Look up in Table 3-317	N/A	
EUL	Effective useful life	See Measure Life Section	Years	
RUL	Remaining useful life	See Measure Life Section	Years	

Table 3-315 GPD

Building Type	GPD	Rate	Notes/Assumptions	Source
Assembly	239	7.02 GPD per 1,000 SF	Assumes 34,000 SF	EIA926: Public Assembly
Auto Repair	25	4.89 GPD per 1,000 SF	Assumes 5,150 SF	EIA: Other
Big Box Retail	448	3.43 GPD per 1,000 SF	Assumes 130,500 SF	EIA: Mercantile
Community College	1,520	1.9 GPD per person	Assumes 800 students	NREL927: School with Showers
Dormitory	8,600	17.2 GPD per resident	Assumes 500 residents	Water Research Foundation928

¹³⁷ Average value across 5 NJ climate zones. Calculated from annual average ambient air temperature + 6 °F.

Building Type	GPD	Rate	Notes/Assumptions	Source
Elementary School	250	0.5 GPD per student	Assumes 500 students	NREL: School
Fast Food Restaurant	500	500 GPD per restaurant		FSTC929: Quick Service
Full-Service Restaurant	2,500	2,500 GPD per restaurant		FSTC: Full Service
Grocery	172	3.43 GPD per 1,000 SF	Assumes, 50,000 SF	EIA: Mercantile
High School	1,520	1.9 GPD per person	Assumes 800 students	NREL: School with Showers
Hospital	16,938	54.42 GPD per 1,000 SF	Assumes 250,000 SF	EIA: Health Care, Inpatient
Hotel	9,104	45.52 GPD per 1,000 SF	Assumes 200,000 SF	EIA: Lodging
Large Office	550	1.1 GPD per person	Assumes 500 people	NREL: Office
Large Retail	446	3.43 GPD per 1,000 SF	Assumes 130,000 SF	EIA: Mercantile
Light Industrial	489	4.89 GPD per 1,000 SF	Assumes 100,000 SF	EIA: Other
Motel	1,366	45.52 GPD per 1,000 SF	Assumes 30,000 SF	EIA: Lodging
Multifamily High-Rise	4,600	46 GPD per unit	Assumes 100 units	Water Research Foundation
Multifamily Low-Rise	552	46 GPD per unit	Assumes 12 units	Water Research Foundation
Refrigerated Warehouse	86	0.93 GPD per 1,000 SF	Assumes 92,000 SF	EIA: Warehouse and Storage
Religious	77	7.02 GPD per 1,000 SF	Assumes 11,000 SF	EIA: Public Assembly
Small Office	110	1.1 GPD per person	Assumes 100 people	NREL: Office
Small Retail	27	3.43 GPD per 1,000 SF	Assumes 8,000 SF	EIA: Mercantile
University	1,000	0.5 GPD per student	Assumes 2,000 students	NREL: School
Warehouse	465	0.93 GPD per 1,000 SF	Assumes 500,000 SF	EIA: Warehouse and Storage
Other	Calculate	4.89 GPD per 1,000 SF		EIA: Other

Table 3-316 Thermal efficiency baseline

Electric	Gas
0.98	0.80

Peak Factors

Table 3-317 Peak Factors

Peak Factor	Value	Ref
Electric coincidence factor (CF)	0.8	[166]
Natural gas peak day factor (PDF)	See	

Measure Life

The remaining useful life (RUL) for existing equipment is limited to 1/3 of the effective useful life (EUL) of the equipment.

Equipment	EUL	RUL	Ref
Commercial Storage Water Heater	15	5	[164]

References

- [157] U.S. Energy Information Administration, 2012 Commercial Buildings Energy Consumption Survey: Water Consumption in Large Buildings, Table WD1. Daily water consumption in large commercial buildings, 2012
- [158] National Renewable Energy Laboratory, Saving Energy in Commercial Buildings: Domestic Hot Water Assessment Guidelines, Table 1. Hot Water Use By Building Type, June 2011
- [159] Water Research Foundation: Residential End Uses of Water, Version 2, April 2016
- [160] Food Service Technology Center, Design Guide – Energy Efficient Heating, Delivery and Use, Table 1. Typical hot water system cost for restaurants, March 2010
- [161] “Legionellosis (Legionnaires’ Disease and Pontiac Fever) – Control Prevention – Occupational Safety and Health Administration.” <https://www.osha.gov/legionnaires-disease/control-prevention>.
- [162] Water heaters are generally located in conditioned or partially conditioned spaces with a typical average temperature of 65°F to 70°F to avoid freezing. A value of 70°F is used for the purposes of estimating tank/ambient air temperature differential, which aligns with standby loss specification testing standards.
- [163] 10 CFR 430 Appendix E to Subpart B of Part 430 Uniform Test Method for Measuring the Energy Consumption of Water Heaters, Section 2. Test Conditions, 2.5 Set Point Temperature
<https://www.ecfr.gov/current/title-10/chapter-II/subchapter-D/part-430/subpart-B/appendix-Appendix%20E%20to%20Subpart%20B%20of%20Part%20430>
- [164] 10 CFR 431.110 (a) – Energy conservation standards and their effective dates.
<https://www.ecfr.gov/current/title-10/chapter-II/subchapter-D/part-431/subpart-G/subject-group-ECFR4c2d09a7e7a11ca/section-431.110> California Public Utilities Commission Database for Energy Efficient Resources (DEER) EUL Support Table for 2020,
<http://www.deeresources.com/files/DEER2020/download/SupportTable-EUL2020.xlsx>.
- [165] Burch, Jay and Christensen, Craig, "Towards Development of an Algorithm for Mains Water Temperature." National Renewable Energy Laboratory, 2022
- [166] New York Standard Approach for Estimating Energy Savings from Energy Efficiency Programs (TRM), Version 9, January 2022.
[https://www3.dps.ny.gov/W/PSCWeb.nsf/96f0fec0b45a3c6485257688006a701a/72c23decff52920a85257f1100671bdd/\\$FILE/NYS%20TRM%20V9.pdf](https://www3.dps.ny.gov/W/PSCWeb.nsf/96f0fec0b45a3c6485257688006a701a/72c23decff52920a85257f1100671bdd/$FILE/NYS%20TRM%20V9.pdf).

3.11.2 TANKLESS WATER HEATER

Market	Commercial
Baseline Type	NC/TOS/RF/DI/EREP
Baseline	Code/Existing/Dual
End Use Subcategory	Water Heating
Measure Last Reviewed	December 2022

Description

This measure covers the installation of high-efficiency fossil fuel and electric instantaneous water heaters, which heat water but contain no more than one gallon of water per 4,000 Btu/h of input. It is applicable to fossil fuel-fired instantaneous water heaters with a rated input greater than 200,000 Btu/h and electric instantaneous water heaters with a rated input greater than 12 kW. This measure applies to potable hot water delivery only; it is not applicable to water heaters used for process loads or space heating.

This measure applies to replacement of existing storage type water heaters using the same heating fuel (fossil fuel or electric) as the efficient case. For new construction, this measure assumes baseline to be a standard efficiency water heater using the same heating fuel (fossil fuel or electric) as the efficient case.

Baseline Case

The baseline condition is a standard efficiency fossil fuel or electric storage type water heater (fuel type equivalent to the efficient case) with tank volume and input capacity equivalent to those of the existing equipment, UA value calculated as prescribed below and a thermal efficiency of 0.80 (fossil fuel) or 0.98 (electric). If existing tank volume is unknown, assume a 120-gallon storage type water heater with an input capacity of 200,000 Btu/h.

Efficient Case

The compliance condition is a fossil fuel or electric instantaneous water heater as defined in the Measure Description section above. Fossil fuel tankless water heaters must meet the minimum qualifying efficiency for ENERGY STAR® certification of a thermal efficiency greater than or equal to 0.94. Electric tankless water heaters must meet or exceed the efficiency of the baseline condition with a thermal efficiency greater than or equal to 0.98.

Annual Energy Savings Algorithm

Annual Electric Energy Savings

$$\Delta kWh = kWh_b - kWh_q$$
$$\Delta kWh = \frac{GPD \times 365 \times 8.33 \times \Delta T_{main}}{3,412} \times \left(\frac{1}{E_{t,b}} - \frac{1}{E_{t,q}} \right) + \frac{UA_b \times \Delta T_{amb} \times 8,760}{E_{t,b} \times 3,412}$$

Where,

$$kWh_b = \frac{GPD \times 365 \times 8.33 \times \Delta T_{main}}{3,412 \times E_{t,b}} + \frac{UA_b \times \Delta T_{amb} \times 8,760}{E_{t,b} \times 3,412} \text{ (Electric Baseline)}$$

$$kWh_b = 0 \text{ (Fossil Fuel Baseline)}$$

$$kWh_q = \frac{GPD \times 365 \times 8.33 \times \Delta T_{main}}{3,412 \times E_{t,q}} \text{ (Electric Energy Efficient Case)}$$

$$kWh_q = 0 \text{ (Fossil Fuel Energy Efficient Case)}$$

$$\Delta T_{main} = T_{set} - T_{main}$$

$$\Delta T_{amb} = T_{set} - T_{amb}$$

$$UA_b = \frac{SL_b}{70}$$

For baseline of large electric storage type water heaters (> 12kW and > 20 gallons):

$$SL_b = \frac{\left(0.3 + \frac{27}{v_b}\right)}{100} \times 70 \times v_b \times 8.33$$

Annual Fuel Savings

$$\Delta Therms = \frac{GPD \times 365 \times 8.33 \times \Delta T_{main}}{100,000} \times \left(\frac{1}{E_{t,b}} - \frac{1}{E_{t,q}}\right) + \frac{UA_b \times \Delta T_{amb} \times 8,760}{E_{t,b} \times 100,000}$$

Where,

$$\Delta Therms = Therms_b - Therms_q$$

$$Therms_b = \frac{GPD \times 365 \times 8.33 \times \Delta T_{main}}{100,000 \times E_{t,b}} + \frac{UA_b \times \Delta T_{amb} \times 8,760}{E_{t,b} \times 100,000} \text{ (Fossil Fuel Baseline)}$$

$$Therms_b = 0 \text{ (Electric Baseline)}$$

$$Therms_q = \frac{GPD \times 365 \times 8.33 \times \Delta T_{main}}{100,000 \times E_{t,q}} \text{ (Fossil Fuel Energy Efficient Case)}$$

$$Therms_q = 0 \text{ (Electric Energy Efficient Case)}$$

$$\Delta T_{main} = T_{set} - T_{main}$$

$$\Delta T_{amb} = T_{set} - T_{amb}$$

$$UA_b = \frac{SL_b}{70}$$

For baseline of large oil and gas storage type water heaters (> 75,000 BTU/h input capacity (Q) and storage size > 1 gallon per 4000 Btu/h):

$$SL_b = \frac{Q_b}{800} + 110\sqrt{v_b}$$

Peak Demand Savings

$$\Delta kW_{Peak} = \frac{\Delta kWh}{8,760} \times CF$$

Daily Peak Fuel Savings

$$\Delta Therms_{Peak} = \Delta Therms \times PDF$$

Lifetime Energy Savings Algorithms

Lifetime Electric Energy Savings

$$\Delta kWh_{Life} = \Delta kWh \times EUL$$

Lifetime Fuel Savings

$$\Delta Therms_{Life} = \Delta Therms \times EUL$$

Dual:

Lifetime Electric Energy Savings

$$\Delta kWh_{Life} = \Delta kWh_{EREP} \times RUL + \Delta kWh_{NR} \times EUL$$

Lifetime Fuel Savings

$$\Delta Therms_{Life} = \Delta Therms_{EREP} \times RUL + \Delta Therms_{NR} \times EUL$$

Calculation Parameters

Table 3-318 Calculation Parameters

Variable	Description	Value	Units	Ref
ΔkWh	Annual electric energy savings	Calculated	kWh/yr	
ΔTherms	Annual fuel savings	Calculated	Therms/yr	
ΔkW _{Peak}	Peak Demand Savings	Calculated	kW	
ΔTherms _{Peak}	Daily peak fuel savings	Calculated	Therms/day	
ΔT _{main}	Average temperature difference between water heater set point and the supply water temperature in water main	Calculated	°F	

Variable	Description	Value	Units	Ref
ΔT_{amb}	Average temperature difference between water heater set point and the surrounding ambient air temperature	Calculated	°F	
UA_b	Overall heat loss coefficient of the baseline condition, calculate based on baseline standby loss	Calculated	N/A	
$E_{t,q}$	Thermal efficiency for energy efficient measure	Site-specific	N/A	
GPD	Gallons per day	Site-specific, if unknown look up in Table 3-319	Gal/day	[167][168] [169][170]
v_b	Baseline tank volume	Site-specific, if unknown use 120	gal	
Q_b	Baseline input capacity	Site-specific, if unknown use 200,000	Btu/h	
$E_{t,b}$	Thermal efficiency of the baseline condition	For retrofit, use site-specific existing value. If unknown, use 0.80 for fossil fuel and 0.98 for electric. For new construction, look up in Appendix E: Code-Compliant Efficiencies	N/A	[173]
T_{set}	Water heater set point temperature	125	°F	[171]
T_{main}	Supply water temperature in water main	60	°F	[172]
T_{amb}	Surrounding ambient air temperature	70 ¹³⁸	°F	
365	Days per year	365	Days/yr	
3,412	Conversion from Btu to kWh	3,412	Btu/kWh	
8.33	Energy required (Btu) to heat one gallon of water by one degree Fahrenheit	8.33	Btu/gal°F	
100,000	Conversion from Btu to therms	100,000	Btu/therm	
70	Temperature difference associated with standby loss specification	70	(°F)	
CF	Coincident Factor	Look up in Table 3-320	N/A	
PDF	Peak day factor	Look up in Table 3-320	N/A	
EUL	Effective useful life	See Measure Life Section	Years	

¹³⁸ Water heaters are generally located in conditioned or partially conditioned spaces with a typical average temperature of 65°F to 70°F to avoid freezing. A value of 70°F is used for the purposes of estimating tank/ambient air temperature differential, which aligns with standby loss specification testing standards.

Variable	Description	Value	Units	Ref
RUL	Remaining useful life of existing unit	See Measure Life Section	Years	

The average daily hot water usage, expressed in gallons per day, for several commercial facility types is tabulated below. Daily hot water usage can be calculated based on the GPD and site-specific metric in the Rate column, or default values can be referenced directly from the GPD column.

Table 3-319 GPD by Facility Type

Building Type	GPD	Rate	Notes	Source
Assembly	239	7.02 GPD per 1,000 SF	Assumes 34,000 SF, 10% hot water	EIA: Public Assembly
Auto Repair	25	4.89 GPD per 1,000 SF	Assumes 5,150 SF, 10% hot water	EIA: Other
Big Box Retail	448	3.43 GPD per 1,000 SF	Assumes 130,500 SF, 10% hot water	EIA: Mercantile
Community College	1,520	1.9 GPD per person	Assumes 800 students	NREL School with Showers
Dormitory	8,600	17.2 GPD per resident	Assumes 500 residents	Water Research Foundation
Elementary School	250	0.5 GPD per student	Assumes 500 students	NREL: School
Fast Food Restaurant	500	500 GPD per restaurant		FSTC: Quick Service
Full-Service Restaurant	2,500	2,500 GPD per restaurant		FSTC: Full Service
Grocery	172	3.43 GPD per 1,000 SF	Assumes 50,000 SF, 10% hot water	EIA: Mercantile
High School	1,520	1.9 GPD per person	Assumes 800 students	NREL: School with Showers
Hospital	16,938	54.42 GPD per 1,000 SF	Assumes 40% hot water, 250,000 SF	250,000 SF EIA: Health Care, Inpatient
Hotel	9,104	45.52 GPD per 1,000 SF	Assumes 40% hot water, 200,000 SF	EIA: Lodging
Large Office	550	1.1 GPD per person	Assumes 500 people	NREL: Office
Large Retail	446	3.43 GPD per 1,000 SF	Assumes 130,000 SF, 10% hot water	EIA: Mercantile
Light Industrial	489	4.89 GPD per 1,000 SF	Assumes 100,000 SF, 10% hot water	EIA: Other
Motel	1,366	45.52 GPD per 1,000 SF	Assumes 30,000 SF, 40% hot water	EIA: Lodging
Multifamily High-Rise	4,550	45.5 GPD per unit	Assumes 100 units	Water Research Foundation
Multifamily Low-Rise	546	45.5 GPD per unit	Assumes 12 units	Water Research Foundation

Building Type	GPD	Rate	Notes	Source
Refrigerated Warehouse	86	0.93 GPD per 1,000 SF	Assumes 92,000 SF, 10% hot water	EIA: Warehouse and Storage
Religious	77	7.02 GPD per 1,000 SF	Assumes 11,000 SF, 10% hot water	EIA: Public Assembly
Small Office	110	1.1 GPD per person	Assumes 100 people	NREL: Office
Small Retail	27	3.43 GPD per 1,000 SF	Assumes 8,000 SF, 10% hot water	EIA: Mercantile
University	1,000	0.5 GPD per student	Assumes 2,000 students	NREL: School
Warehouse	465	0.93 GPD per 1,000 SF	Assumes 500,000 SF, , 10% hot water	EIA: Warehouse and Storage
Other	Calculate	4.89 GPD per 1,000 SF	Assumes 10% hot water	EIA: Other

Peak Factors

Table 3-320 Peak Factors

Peak Factor	Value	Ref
Electric coincidence factor (CF)	0.8	[175]
Natural gas peak day factor (PDF)	See Appendix G: Natural Gas Peak Day Factors	

Measure Life

The remaining useful life (RUL) for retrofit projects is limited to 1/3 of the effective useful life (EUL) of the equipment.

Table 3-321 Measure Life

Equipment	New construction EUL	Retrofit RUL	Ref
Instantaneous Water Heater	20	6.66	[175]

References

- [167] U.S. Energy Information Administration, 2012 Commercial Buildings Energy Consumption Survey: Water Consumption in Large Buildings, Table WD1. Daily water consumption in large commercial buildings, 2012.
- [168] National Renewable Energy Laboratory, Saving Energy in Commercial Buildings: Domestic Hot Water Assessment Guidelines, Table 1. Hot Water Use By Building Type, June 2011.
- [169] *Water Research Foundation: Residential End Uses of Water, Version 2*, (April 2016) Pg 5.
https://www.circleofblue.org/wp-content/uploads/2016/04/WRF_REU2016.pdf
- [170] Food Service Technology Center, Design Guide – Energy Efficient Heating, Delivery and Use, Table 1. Typical hot water system cost for restaurants, March 2010.
- [171] 10 CFR 430 Appendix E to Subpart B of Part 430 Uniform Test Method for Measuring the Energy Consumption of Water Heaters, Section 2. Test Conditions, 2.5 Set Point Temperature, December 2022.

- [172] Burch, Jay and Christensen, Craig, "Towards Development of an Algorithm for Mains Water Temperature." National Renewable Energy Laboratory, 2022.
- [173] Fuel: 10 CFR 431.110 (a), December 2022.
- [174] New York Standard Approach for Estimating Energy Savings from Energy Efficiency Programs (TRM), Version 10, January 2023.
[https://www3.dps.ny.gov/W/PSCWeb.nsf/96f0fec0b45a3c6485257688006a701a/72c23decff52920a85257f1100671bdd/\\$FILE/NYS%20TRM%20V10.pdf](https://www3.dps.ny.gov/W/PSCWeb.nsf/96f0fec0b45a3c6485257688006a701a/72c23decff52920a85257f1100671bdd/$FILE/NYS%20TRM%20V10.pdf)
- [175] California Public Utilities Commission Database for Energy Efficient Resources (DEER) EUL Support Table for 2020. <http://www.deeresources.com/files/DEER2020/download/SupportTable-EUL2020.xlsx>

3.11.3 HEAT PUMP WATER HEATER

Market	Commercial
Baseline Condition	TOS/NC/EREP/DI
Baseline	Code/Dual
End Use Subcategory	Equipment
Measure Last Reviewed	January 2023

Description

This measure covers the installation of electric storage tank water heaters that use heat pump technology to move heat from the air (in conditioned or unconditioned spaces) to the water storage tank and are designed to heat and store potable water at a thermostatically controlled temperature of less than 180°F. It is not intended for equipment delivering process or space heating hot water. The best applications of heat pump water heater is in a space where cooling is desired year round. Heat pump water heater interactions with the HVAC system should be calculated according to the existing HVAC system (TOS) in existing buildings or the planned HVAC system in new construction (NC).

Baseline Case

Baseline equipment for TOS/NC projects is a minimally code-compliant, electric storage type water heater. For EREP/DI projects, the baseline equipment is a minimally code-compliant water heater of the same type and fuel as the existing equipment.

Efficient Case

The efficient condition is an ENERGY STAR version 5.0 qualified commercial heat pump water heater.

Annual Energy Savings Algorithms

Annual Electric Energy Savings

$$\Delta kWh = \Delta kWh_{dhw} + \Delta kWh_{cooling} - \Delta kWh_{heating}$$

Where,

$$Load_{dhw} = GPD \times 365 \times 8.33 \times (T_{set} - T_{main})$$

$$\Delta kWh_{dhw} = \frac{Load_{dhw}}{3,412} \times \left(\frac{F_{dhw,electric}}{UEF_b} - \frac{1}{COP_q \times F_{derate}} \right)$$

$$\Delta kWh_{cooling} = \frac{Load_{dhw}}{1,000} \times \left(1 - \frac{1}{COP_q} \right) \times F_{location} \times \frac{F_{cool}}{IEER}$$

$$\Delta kWh_{heating} = \frac{Load_{dhw}}{1,000} \times \left(1 - \frac{1}{COP_q} \right) \times F_{location} \times F_{heat,electric} \times \frac{F_{heat}}{COP \times 3.412}$$

Annual Fuel Savings

$$\Delta Therms = \Delta Therms_{dhw} - \Delta Therms_{heating}$$

Where,

$$\Delta Therms_{dhw} = \frac{Load_{dhw}}{100,000} \times \left(\frac{F_{dhw,ff}}{UEF_b} + \frac{F_{dhw,boiler}}{E_t} \right)$$

$$\Delta Therms_{heating} = \frac{Load_{dhw}}{100,000} \times \left(1 - \frac{1}{COP_q} \right) \times F_{location} \times F_{heat,ff} \times \frac{F_{heat}}{E_t}$$

Peak Demand Savings

$$\Delta kW_{peak} = \Delta kWh \times F_{ETD}$$

Daily Peak Fuel Savings

$$\Delta Therms_{peak} = \Delta Therms \times PDF$$

Lifetime Energy Savings Algorithms

Lifetime Electric Energy Savings

$$\Delta kWh_{Life} = \Delta kWh \times EUL$$

Lifetime Fuel Savings

$$\Delta Therms_{Life} = \Delta Therms \times EUL$$

Dual:

Lifetime Electric Energy Savings

$$\Delta kWh_{Life} = \Delta kWh_{EREP} \times RUL + \Delta kWh_{NR} \times EUL$$

Lifetime Fuel Savings

$$\Delta Therms_{Life} = \Delta Therms_{EREP} \times RUL + \Delta Therms_{NR} \times EUL$$

Calculation Parameters

Table 3-322 Calculation Parameters

Variable	Description	Value	Units	Ref
ΔkWh	Annual electric energy savings	Calculated	kWh/yr	
ΔkWh_{dhw}	Annual domestic hot water electric energy savings	Calculated	kWh/yr	
$\Delta kWh_{cooling}$	Annual cooling electric energy savings	Calculated	kWh/yr	

Variable	Description	Value	Units	Ref
$\Delta kWh_{\text{heating}}$	Annual heating electric energy impacts	Calculated	kWh/yr	
ΔTherms	Annual fuel savings	Calculated	Therms/yr	
$\Delta \text{Therms}_{\text{dhw}}$	Annual domestic hot water fuel savings	Calculated	Therms/yr	
$\Delta \text{Therms}_{\text{heat}}$	Annual space heating fuel impacts	Calculated	Therms/yr	
ΔkW_{Peak}	Peak Demand Savings	Calculated	kW	
$\Delta \text{Therms}_{\text{Peak}}$	Daily peak fuel savings	Calculated	Therms/day	
ΔkWh_{Life}	Lifetime electric energy savings	Calculated	kWh	
$\Delta \text{Therms}_{\text{Life}}$	Lifetime fuel savings	Calculated	Therms	
Load_{dhw}	Annual hot water load	Calculated	Btu	
GPD	Gallons per day	Look up in Table 3-323	Gal/day	[181]
v_r	Rated storage volume	Site-specific	Gal	
E_t	Thermal efficiency of space heating boiler or furnace	Site-specific, if unknown, look up in Table 3-329	N/A	[178]
COP_q	Coefficient of Performance of efficient unit	Site-specific, if unknown look up in Table 3-326	N/A	[177]
UEF_b	Uniform energy factor of baseline unit	Look up in Table 3-325	N/A	[177]
F_{derate}	Efficiency derating factor	Look up in Table 3-331	N/A	[178]
F_{location}	Installation location factor	Look up in Table 3-331	N/A	
$F_{\text{DHW,electric}}$	Electric water heating factor	Look up in Table 3-324	N/A	
$F_{\text{DHW,ff}}$	Fossil fuel water heating factor	Look up in Table 3-324	N/A	
$F_{\text{DHW,boiler}}$	Fossil fuel boiler heating factor	Look up in Table 3-324	N/A	
$F_{\text{heat,electric}}$	Electric heating factor	Look up in Table 3-324	N/A	
$F_{\text{heat,ff}}$	Fossil fuel heating factor	Look up in Table 3-324	N/A	
F_{heat}	Heating factor, used to account for the percentage of heat extracted from ambient air by the heat pump water heater that increases space heating load	0.49	N/A	

Variable	Description	Value	Units	Ref
F_{cool}	Cooling factor, used to account for the percentage of heat extracted from ambient air by the heat pump water heater that reduces space cooling load	0.51	N/A	
IEER	Space cooling Integrated energy efficiency ratio	Look up in Table 3-328	Btu/W·hr	[181]
COP	Space heating COP	Look up in Table 3-326	N/A	[181]
T_{main}	Supply water temperature in water main	Look up in Table 3-330	°F	[180]
F_{ETD}	Energy to demand factor	Look up in Table 3-331	N/A	
T_{set}	Water heater setpoint temperature	140	°F	[176]
365	Days per year	365	Days/yr	
8.33	Unit conversion, Btu/gal·°F	8.33	Btu/gal·°F	
3,412	Unit conversion, Btu/kWh	3,412	Btu/kWh	
3.412	Unit conversion, Btu/W·hr	3.412	Btu/W·hr	
1000	Unit conversion, Watt/kW	1000	W/kW	
100,000	Unit conversion, Btu/therm	100,000	Btu/therm	
CF	Electric coincidence factor	Look up in Table 3-332	N/A	
PDF	Gas peak demand factor	Look up in Table 3-332	N/A	
EUL	Effective useful life	See Measure Life Section	Years	

Table 3-323 Gallons Per Day

Building Type	GPD	Rate	Notes/Assumptions	Source
Assembly	239	7.02 GPD per 1,000 SF	Assumes 34,000 SF	EIA926: Public Assembly
Auto Repair	25	48.9 GPD per 1,000 SF	Assumes 5,150 SF	EIA: Other
Big Box Retail	448	34.3 GPD per 1,000 SF	Assumes 130,500 SF	EIA: Mercantile
Community College	1,520	1.9 GPD per person	Assumes 800 students	NREL927: School with Showers
Dormitory	8,600	17.2 GPD per resident	Assumes 500 residents	Water Research Foundation928
Elementary School	250	0.5 GPD per student	Assumes 500 students	NREL: School
Fast Food Restaurant	500	500 GPD per restaurant		FSTC929: Quick Service
Full-Service Restaurant	2,500	2,500 GPD per restaurant		FSTC: Full Service

Building Type	GPD	Rate	Notes/Assumptions	Source
Grocery	172	3.43 GPD per 1,000 SF	Assumes, 50,000 SF	EIA: Mercantile
High School	1,520	1.9 GPD per person	Assumes 800 students	NREL: School with Showers
Hospital	16,938	54.42 GPD per 1,000 SF	Assumes 250,000 SF	EIA: Health Care, Inpatient
Hotel	9,104	45.52 GPD per 1,000 SF	Assumes 200,000 SF	EIA: Lodging
Large Office	550	1.1 GPD per person	Assumes 500 people	NREL: Office
Large Retail	446	3.43 GPD per 1,000 SF	Assumes 130,000 SF	EIA: Mercantile
Light Industrial	489	4.89 GPD per 1,000 SF	Assumes 100,000 SF	EIA: Other
Motel	1,366	45.52 GPD per 1,000 SF	Assumes 30,000 SF	EIA: Lodging
Multifamily High-Rise	4,600	46 GPD per unit	Assumes 100 units	Water Research Foundation
Multifamily Low-Rise	552	46 GPD per unit	Assumes 12 units	Water Research Foundation
Refrigerated Warehouse	86	0.93 GPD per 1,000 SF	Assumes 92,000 SF	EIA: Warehouse and Storage
Religious	77	7.02 GPD per 1,000 SF	Assumes 11,000 SF	EIA: Public Assembly
Small Office	110	1.1 GPD per person	Assumes 100 people	NREL: Office
Small Retail	27	3.43 GPD per 1,000 SF	Assumes 8,000 SF	EIA: Mercantile
University	1,000	0.5 GPD per student	Assumes 2,000 students	NREL: School
Warehouse	465	0.93 GPD per 1,000 SF	Assumes 500,000 SF	EIA: Warehouse and Storage
Other	Calculate	4.89 GPD per 1,000 SF		EIA: Other

Table 3-324 DHW and Heating Savings Factors

Baseline Scenario	$F_{DHW,electric}$	$F_{DHW,g}$	$F_{DHW,boiler}$	$F_{heat,electric}$	$F_{heat,g}$
NC/TOS: Use electric baseline	1.0	0	0	1.0	0
EREP/DI with electric baseline	1.0	0	0	1.0	0
EREP/DI with gas baseline	0	1.0	1.0	0	1.0

Table 3-325 Baseline UEF

Rated Storage Volume (v_r)	UEF _b
> 20 and ≤ 55 gallons	$0.96 - (0.0003 \times v_r)$
> 55 and < 120 gallons	$2.057 - (0.00113 \times v_r)$

Table 3-326 Efficient COP_q

Product Class	COP _q
Commercial Heat Pump Water Heater	3.0

Table 3-327 Derating Factors

Area	F _{derate}	F _{location}
Unconditioned Space	0.77	0
Conditioned Space	1.16	1
Kitchen	1.45	1
Unknown (Midstream Delivery)	1.00	1

Table 3-328 IEER and COP Values

Type	IEER	COP
Air Conditioner	12.7	1.0
Air-Source Heat Pump	12.7	3.3

Table 3-329 E_t Values

Equipment Type	Size Range	E _t
Warm Air Furnace, Gas Fired	All Capacities	0.80
Boiler, Hot Water, Gas Fired	All Capacities	0.80
Boiler, Steam, Gas Fired	All Capacities	0.77

Table 3-330 Supply Water Temperature

Climate Region	T _{main}
Northern	56
Southern	58
Coastal	60
Central	58
Pine Barrens	58

Table 3-331 F_{ETD} by building type

Building Type	ETDF
Education - Other	0.0002545
Health - Hospital	0.0002011
Health - Other	0.0003020
Lodging	0.0001210

Building Type	ETDF
Miscellaneous/Other	0.0002590
Office	0.0002490
Restaurant	0.0001525
Retail	0.0002560
Warehouse - Refrigerated	0.0003018

Peak Factors

Peak coincidence is incorporated in the energy to demand factor presented above.

Table 3-332 Peak Factors

Peak Factor	Value	Ref
Electric coincidence factor (CF)	N/A	
Natural gas peak day factor (PDF)	TBD	

Measure Life

The remaining useful life (RUL) for existing equipment is limited to 1/3 of the effective useful life (EUL) of the equipment.

Table 3-333 Measure Life

Equipment	EUL	RUL	Ref
Heat Pump Water Heater	10	3.37	[179]

References

- [176] "Legionellosis (Legionnaires' Disease and Pontiac Fever) – Control Prevention – Occupational Safety and Health Administration." <https://www.osha.gov/legionnaires-disease/control-prevention>.
- [177] 10 CFR Subpart C of Part 430, <https://www.ecfr.gov/current/title-10/chapter-II/subchapter-D/part-430/subpart-C/section-430.32>
- [178] ENERGY STAR Program Requirements Product Specification for Commercial Water Heaters, Eligibility Criteria, Version 2.0. (2021),
- [179] California Public Utilities Commission Database for Energy Efficient Resources (DEER) EUL Support Table for 2020, <http://www.deeresources.com/files/DEER2020/download/SupportTable-EUL2020.xlsx>. Accessed November 13, 2018
- [180] NSRDB, TMY3 data, December 2022. <https://nsrdb.nrel.gov/data-sets/tmy>
- [181] International Energy Conservation Code (IECC) 2022

3.11.4 FAUCET AERATORS AND SHOWERHEADS

Market	Commercial/Multifamily
Baseline Condition	RF/DI
Baseline	Existing/Dual
End Use Subcategory	Control
Measure Last Reviewed	December 2022

Description

This measure covers the installation of low-flow faucet aerators and showerheads in commercial, industrial, and multifamily applications. In multifamily applications, only units installed in common areas are eligible for this measure. Savings for low-flow faucet aerator and showerhead measures are determined using the total change in flow rate (gallons per minute) from the baseline (existing) fixture to the efficient fixture.

Baseline Case

The aerator baseline is a standard faucet with a 2.2 gpm flow rate. The showerhead baseline is an existing showerhead with a 2.5 gpm flow rate. For direct install programs, utilities may choose to measure the actual flow rate of the existing aerator faucet or showerhead and for use that in the algorithm below.

Efficient Case

The efficient condition is an energy efficient faucet aerator or showerhead meeting requirements of NJ P.L. 2021, c. 464. If actual flow rates of the baseline fixtures are used in a direct install program, then the actual flow rate of the installed aerators or showerhead can be used as well.

Annual Energy Savings Algorithm

Annual Electric Energy Savings

$$\Delta kWh = \Delta H2O \times (T_{operating} - T_{main}) \times \frac{8.33}{3,412 \times E_{t,elec}}$$

Where,

$$\Delta H2O = (GPM_b \times F_{Throttle,b} - GPM_q \times F_{Throttle,q}) \times \frac{Minutes}{Day} \times Days$$

$$\frac{Minutes}{Day} = \frac{Minutes}{Use} \times \frac{Uses}{Day}$$

Annual Fuel Savings

$$\Delta Therms = \frac{\Delta H_{2O} \times (T_{operating} - T_{main}) \times 8.33}{(100,000 \times E_{t,fuel})}$$

Peak Demand Savings

$$\Delta kW_{Peak} = N/A$$

Daily Peak Fuel Savings

$$\Delta Therms_{Peak} = \Delta Therms \times PDF$$

Lifetime Energy Savings Algorithms

Lifetime Electric Energy Savings

$$\Delta kWh_{Life} = \Delta kWh \times EUL$$

Lifetime Fuel Savings

$$\Delta Therms_{Life} = \Delta Therms \times EUL$$

Dual:

Lifetime Electric Energy Savings

$$\Delta kWh_{Life} = \Delta kWh_{EREP} \times RUL + \Delta kWh_{NR} \times EUL$$

Lifetime Fuel Savings

$$\Delta Therms_{Life} = \Delta Therms_{EREP} \times RUL + \Delta Therms_{NR} \times EUL$$

Calculation Parameters

Table 3-334 Calculation Parameters

Variable	Description	Value	Units	Ref
ΔkWh	Annual electric energy savings	Calculated	kWh/yr	
$\Delta Therms$	Annual fuel savings	Calculated	Therms/yr	
ΔkW_{Peak}	Peak Demand Savings	Calculated	kW	
$\Delta Therms_{Peak}$	Daily peak fuel savings	Calculated	Therms/day	
ΔH_2O	Annual water savings	Calculated	Gal/yr	
GPM _b	Flowrate of baseline fixture	Site-specific. If unknown, use 2.2 (faucets) 2.5 (showerheads)	Gal/min	[190][191]

Variable	Description	Value	Units	Ref
GPM_q	Flowrate of efficient fixture	Site-specific. If unknown, look up in Table 3-335	Gal/min	[182]
$F_{throttle,b}$	Flowrate restricted: ratio of user setting to full throttle flow rate for baseline fixture	0.83 (faucets) 0.90 (showerheads)	N/A	[183]
$F_{throttle,q}$	Flowrate rescricted: ratio of user setting to full throttle flowrate for efficient fixture	0.95 (faucets) 0.90 (showerheads)	N/A	[183]
$T_{operating}$	Fixture operating temperature	Look up in Table 3-335	°F	[184]
T_{main}	Temperature of supply water temperature in water main ¹³⁹	60	°F	[185]
min/use	Average duration a fixture runs each time it is used	0.5 (faucet) 8.2 (showerhead)	min	[186]
uses/day	Number of times the fixture is used per day	Site-specific. If unknown, use 60 (faucet) or 2.4 (showerhead)	N/A	[186][187]
min/day	Average minutes of fixture use per day	Calculated. If unknown, use 30 (faucet) or 20 (showerhead)	min	[187]
days	Days fixture used per year	Site-specific. If unknown, look up in 3-344	days/yr	
$E_{t,elec}$	Thermal efficiency of electric water heater	0.98	N/A	[188]
$E_{t,fuel}$	Thermal efficiency of fossil fuel water heater	0.80	N/A	[188]
3,412	Conversion factor from Btu/h to kW	3,412	Btu/h/kW	
100,000	Conversion factor from Btu to therms	100,000	Btu/therm	
CF	Coincidence factor	Look up in Table 3-337	N/A	
PDF	Peak day factor	Look up in Table 3-337	N/A	
EUL	Effective useful life of new unit	See Measure Life Section	Years	
RUL	Remaining useful life of existing unit	See Measure Life Section	Years	

Table 3-335 Installed Flowrates and Fixture Operating Temperatures

Fixture Type	Location	GPM_q	T_{faucet} (°F)
Faucet aerator	Kitchen	1.8	93
	Public restroom	0.5	86
	Private restroom	1.5	86
Showerhead	Any	2.0	105

¹³⁹ Average value across 5 NJ climate zones. Calculated from annual average ambient air temperature + 6°F.

Table 3-336 Operating Days per Year

Building Type	Operating Days per Year	Building Type	Operating Days per Year
Education – Primary School	180	Office – Small	234
Education – Secondary School	210	Restaurant – Sit-Down	364
Education – Community College	237	Restaurant – Fast-Food	364
Education – University	192	Retail – 3-Story Large	355
Grocery	364	Retail – Single-Story Large	364
Medical – Hospital	364	Retail – Small	364
Medical – Clinic	351	Storage Conditioned	330
Lodging Hotel (Guest Rooms)	229	Storage Heated or Unconditioned	330
Lodging Motel	364	Warehouse	325
Manufacturing – Light Industrial	330	Average – Miscellaneous	303
Office – Large	234		

Peak Factors

Table 3-337 Peak Factors

Peak Factor	Value	Ref
Electric coincidence factor (CF)	N/A	
Natural gas peak day factor (PDF)	See Appendix G: Natural Gas Peak Day Factors	

Non-Energy Impacts

Water savings:

$$\Delta H2O = units \times (GPM_b \times F_{throttle,b} - GPM_q \times F_{throttle,q}) \times \frac{min}{day} \times days$$

Measure Life

The remaining useful life (RUL) for existing equipment is limited to 1/3 of the effective useful life (EUL) of the equipment.

Table 3-338 Measure Life

Equipment	EUL	RUL	Ref
Faucet Aerators and Showerheads	10	3.3	[189]

References

- [182] Maximum flow rates for new aerators and showerheads established by New Jersey P.L. 2021, c. 464. <https://pub.njleg.state.nj.us/Bills/2020/PL21/464 .PDF>
- [183] Energy Related Water Fixture Measurements: Securing the Baseline for Northwest Single Family Homes, American Council for an Energy-Efficient Economy, August 2008, pg. 1-265.
- [184] Cadmus and Opinion Dynamics Showerhead and Faucet Aerator Meter Study Memorandum dated June 2013, Directed to Michigan Evaluation Working Group. Table 93 “HEI Updated PY2014 Variable Assumptions”
- [185] Burch, Jay and Christensen, Craig, “Towards Development of an Algorithm for Mains Water Temperature.” National Renewable Energy Laboratory. <https://citeseerx.ist.psu.edu/viewdoc/download?doi=10.1.1.515.6885&rep=rep1&type=pdf>
- [186] FEMP, Domestic Water Conservation Technologies, pg. 35.
- [187] FEMP Cost Calculator: <https://www.ces.ncsu.edu/wp-content/uploads/2014/03/Federal-Energy-Management-Program-Energy-Cost-Calculator-for-Faucets-and-Showerheads.htm>
- [188] 10 CFR 430 Subpart B Appendix E – Uniform Test Method for Measure Energy Consumption of Water Heaters: 6.3.2 *Recovery Efficiency*. <https://www.ecfr.gov/current/title-10/chapter-II/subchapter-D/part-430/subpart-B>
- [189] Measure Life Report, Residential and Commercial/Industrial Lighting and HVAC Measures, GDS Associates, June 2007. <http://www.energizect.com/sites/default/files/Measure%20Life%20Report%202007>
- [190] Existing faucet flow rate assumption taken from Pennsylvania Technical Reference Manual; effective June 2016, pp. 114ff. <http://www.puc.pa.gov/pcdocs/1370278.docx>
- [191] Energy Policy Act (EPAAct) of 1992. <https://afdc.energy.gov/files/pdfs/2527.pdf>

3.11.5 COMBINATION BOILER

Market	Commercial/Multifamily
Baseline Type	TOS/NC/EREP
Baseline	Code/Existing/Dual
End Use Subcategory	Equipment
Measure Last Reviewed	December 2022

Description

This section provides energy savings algorithms for qualifying gas combination boilers installed in commercial and industrial settings. A combination boiler is a space heating system that also has the capability to provide instantaneous domestic hot water. The input values are based on the specifications of the actual equipment being installed, federal equipment efficiency standards, DOE2.2 simulations completed by the NJ SWE and regional estimates of average baseline water heating energy usage.

For new construction, replacement of failed equipment, and end of useful life, the baseline unit is a code compliant unit with an efficiency as required by ASHRAE Std. 90.1 – 2019 and IECC 2021, which are the current codes adopted by the State of New Jersey.

For retrofit programs where an existing boiler is replaced, the baseline efficiency is the existing boiler efficiency. For early replacement programs, the baseline efficiency is the existing boiler efficiency for the remaining life of the existing boiler and a code efficiency boiler for the remaining life of the measure.

Baseline Case

Space Heating Component:

- New Construction/Replacement of Failed Equipment/End of Useful Life: Boiler compliant with ASHRAE Std. 90.1 – 2019 and IECC 2021.
- Retrofit/Direct Install: Existing boiler efficiency for first baseline. If unknown, use minimally code-compliant efficiency based on boiler age. As second baseline, use current code for measure remaining life.

Domestic Hot Water Component:

- New Construction/Replacement of Failed Equipment/End of Useful Life: Water heater compliant with ASHRAE Std. 90.1 – 2019 and IECC 2021.
- Retrofit: Existing water heater efficiency for first baseline. If unknown use minimally code compliant efficiency based on water heater age. As second baseline, use current code for measure remaining life.

Efficient Case

The compliance condition is a combi-boiler unit with a heating efficiency higher than code. Qualifying systems must not have a water storage tank.

Annual Energy Savings AlgorithmAnnual Electric Energy Savings

$$\Delta kWh = N/A$$

Annual Fuel Savings

$$\Delta Therms = \Delta Therms_{Boiler} + \Delta Therms_{DHW}$$

Where,

$$\Delta Therms_{Boiler} = Cap_{in} \times EFLH_h \times \frac{Eff_q/Eff_b - 1}{100}$$

$$\Delta Therms_{DHW} = \frac{GPD \times 365 \times 8.33 \times (T_{set} - T_{main})}{100,000} \times \left(\frac{1}{E_{t,b}} - \frac{1}{Eff_q} \right) + \frac{UA_b}{E_{t,b}} \times \frac{(T_{set} - T_{amb})}{100,000} \times 8,760$$

Peak Demand Savings

$$\Delta kW_{Peak} = N/A$$

Daily Peak Fuel Savings

$$\Delta Therms_{Peak} = \Delta Therms \times PDF$$

Lifetime Energy Savings Algorithms:Lifetime Electric Energy Savings

$$\Delta kWh_{Life} = N/A$$

Lifetime Fuel Savings

No dual baseline:

$$\Delta Therms_{Life} = \Delta Therms \times EUL$$

Dual baseline:

$$\Delta Therms_{Life} = (\Delta Therms \text{ using existing baseline}) \times RUL + (\Delta Therms \text{ using code baseline}) \times (EUL - RUL)$$

Calculation Parameters**Table 3-339 Calculation Parameters**

Variable	Description	Value	Units	Ref
ΔTherms	Annual fuel savings	Calculated	Therms/yr	
$\Delta\text{Therms}_{\text{Peak}}$	Daily peak fuel savings	Calculated	Therms/day	
$\Delta\text{Therms}_{\text{Life}}$	Lifetime fuel savings	Calculated	Therms	
$\Delta\text{Therms}_{\text{Boiler}}$	Annual fuel savings from space heating	Calculated	Therms/day	
$\Delta\text{Therms}_{\text{DHW}}$	Annual fuel savings from water heating	Calculated	Therms/day	
Cap_{in}	Input capacity of qualifying boiler	Site-specific	kBtu/hr	
Eff_q	Boiler proposed efficiency	Site-specific	N/A	
EFLH_h	Boiler equivalent full load hours of operation during heating season	Look up in Appendix C:	Hours	[192]
Eff_b	Boiler baseline efficiency	Look up in Appendix E: Code-Compliant Efficiencies	N/A	[198][199][200]
GPD	Gallons per day of hot water use	Look up in Table 3-340	Gal/day	[201][202][203][204]
100	Unit conversion from kBtu to therm	100	kBtu/therm	
365	Days per year	365	Day/yr	
8.33	Unit conversion, Btu/gal·F	8.33	Btu/gal·F	
100,000	Unit conversion, Btu/therm	100,000	Btu/therm	
$E_{t,b}$	Baseline water heating designation thermal efficiency	0.8	N/A	[195]
T_{set}	Water heater setpoint temperature	125	°F	[193]
T_{main}	Incoming water main temperature ¹⁴⁰	60	°F	[194]
UA_b	Overall heat loss coefficient of the baseline condition ¹⁴¹	7.85	Btu/h·F	[196]

¹⁴⁰ Average value across 5 NJ climate zones. Calculated from annual average ambient air temperature + 6 deg F.

¹⁴¹ Based on computation of heat loss coefficients via conversion equations found in 10 CFR 429, 430, and 431 Docket No. EERE-2015-BT-TP-0007, Energy Conservation Program for Consumer Products and Certain Commercial and Industrial Equipment: Test Procedures for Consumer and Commercial Water Heaters. Heat loss coefficient was calculated for a minimally code compliant fuel storage water heater found to be the most typical in terms of storage and input capacity, representing storage type water heaters of between 20 and 55 gallon capacity (40 gallon, 40,000 Btu/h assumed). Results of heat loss coefficient evaluation for this assumed baseline is used to represent the UA_{baseline} term.

Variable	Description	Value	Units	Ref
T _{amb}	Surrounding ambient air temperature ¹⁴²	70	°F	
8,760	Hours in one year	8760	Hours	
PDF	Peak day factor	Look up in Table 3-341	N/A	
EUL	Estimated useful life	See Measure Life Section	Years	[197]

Table 3-340 Gallons Per Day (GPD)

Building Type	GPD	Rate	Notes	Source
Assembly	239	7.02 GPD per 1,000 SF	Assumes 34,000 SF, 10% hot water	EIA: Public Assembly
Auto Repair	25	4.89 GPD per 1,000 SF	Assumes 5,150 SF, 10% hot water	EIA: Other
Big Box Retail	448	3.43 GPD per 1,000 SF	Assumes 130,500 SF, 10% hot water	EIA: Mercantile
Community College	1,520	1.9 GPD per person	Assumes 800 students	NREL School with Showers
Dormitory	8,600	17.2 GPD per resident	Assumes 500 residents	Water Research Foundation
Elementary School	250	0.5 GPD per student	Assumes 500 students	NREL: School
Fast Food Restaurant	500	500 GPD per restaurant		FSTC: Quick Service
Full-Service Restaurant	2,500	2,500 GPD per restaurant		FSTC: Full Service
Grocery	172	3.43 GPD per 1,000 SF	Assumes 50,000 SF, 10% hot water	EIA: Mercantile
High School	1,520	1.9 GPD per person	Assumes 800 students	NREL: School with Showers
Hospital	16,938	54.42 GPD per 1,000 SF	Assumes 40% hot water, 250,000 SF	250,000 SF EIA: Health Care, Inpatient
Hotel	9,104	45.52 GPD per 1,000 SF	Assumes 40% hot water, 200,000 SF	EIA: Lodging
Large Office	550	1.1 GPD per person	Assumes 500 people	NREL: Office

¹⁴² Water heaters are generally located in conditioned or partially conditioned spaces with a typical average temperature of 65°F to 70°F to avoid freezing. A value of 70°F is used for the purposes of estimating tank/ambient air temperature differential, which aligns with standby loss specification testing standards.

Building Type	GPD	Rate	Notes	Source
Large Retail	446	3.43 GPD per 1,000 SF	Assumes 130,000 SF, 10% hot water	EIA: Mercantile
Light Industrial	489	4.89 GPD per 1,000 SF	Assumes 100,000 SF, 10% hot water	EIA: Other
Motel	1,366	45.52 GPD per 1,000 SF	Assumes 30,000 SF, 40% hot water	EIA: Lodging
Multifamily High-Rise	4,550	45.5 GPD per unit	Assumes 100 units	Water Research Foundation
Multifamily Low-Rise	546	45.5 GPD per unit	Assumes 12 units	Water Research Foundation
Refrigerated Warehouse	86	0.93 GPD per 1,000 SF	Assumes 92,000 SF, 10% hot water	EIA: Warehouse and Storage
Religious	77	7.02 GPD per 1,000 SF	Assumes 11,000 SF, 10% hot water	EIA: Public Assembly
Small Office	110	1.1 GPD per person	Assumes 100 people	NREL: Office
Small Retail	27	3.43 GPD per 1,000 SF	Assumes 8,000 SF, 10% hot water	EIA: Mercantile
University	1,000	0.5 GPD per student	Assumes 2,000 students	NREL: School
Warehouse	465	0.93 GPD per 1,000 SF	Assumes 500,000 SF, 10% hot water	EIA: Warehouse and Storage
Other	Calculate	4.89 GPD per 1,000 SF	Assumes 10% hot water	EIA: Other

Peak Factors

Table 3-341 Peak Factors

Peak Factor	Value	Ref
Electric coincidence factor (CF)	N/A	
Natural gas peak day factor (PDF)	See Appendix G: Natural Gas Peak Day Factors	

Measure Life

The remaining useful life (RUL) for existing equipment is limited to 1/3 of the effective useful life (EUL) of the equipment.

Table 3-342 Measure Life

Equipment	EUL	RUL	Ref
Combination Boiler	22	7.3	[197]

References

- [192] Simulations of prototype buildings from NY TRM updated with NJ weather done by NJ Statewide Evaluator, May 2022
- [193] 10 CFR 430 Appendix E to Subpart B of Part 430 Uniform Test Method for Measuring the Energy Consumption of Water Heaters, Section 2. Test Conditions, 2.5 Set Point Temperature, December 2022.
- [194] Burch, Jay and Christensen, Craig, *Towards Development of an Algorithm for Mains Water Temperature* (National Renewable Energy Laboratory).
<https://citeseerx.ist.psu.edu/viewdoc/download?doi=10.1.1.515.6885&rep=rep1&type=pdf>
- [195] eCFR :: 10 CFR 431.110 -- Energy conservation standards and their effective dates December 1, 2022.
<https://www.ecfr.gov/current/title-10/chapter-II/subchapter-D/part-430>
- [196] "Regulations.gov." n.d. Www.regulations.gov. Accessed December 13, 2022. Based on computation of heat loss coefficients via conversion equations found in 10 CFR 429, 430, and 431 Docket No. EERE-2015-BT-TP-0007, Energy Conservation Program for Consumer Products and Certain Commercial and Industrial Equipment: Test Procedures for Consumer and Commercial Water Heaters. Heat loss coefficient was calculated for a minimally code compliant fuel storage water heater found to be the most typical in terms of storage and input capacity, representing storage type water heaters of between 20 and 55 gallon capacity (40 gallon, 40,000 Btu/h assumed). Results of heat loss coefficient evaluation for this assumed baseline is used to represent the UAbaseline term.
- [197] <https://www.regulations.gov/document/EERE-2015-BT-TP-0007-0004>
- [198] *Technical Support Document: Energy Efficiency Program for Consumer Products and Commercial and Industrial Equipment: Residential Furnaces*. (DOE, 2016), Table 8.2.17.
- [199] *ASHRAE Standard 90.1-2019, Energy Standard for Buildings Except Low-Rise Residential Buildings*. (ASHRAE, 2019), Table 6.8.1-5. <https://www.ashrae.org/technical-resources/standards-and-guidelines/read-only-versions-of-ashrae-standards>
- [200] *ASHRAE Standard 90.1-2013, Energy Standard for Buildings Except Low-Rise Residential Buildings*. (ASHRAE, 2019), Table 6.8.1-5. <https://www.ashrae.org/technical-resources/standards-and-guidelines/read-only-versions-of-ashrae-standards>
- [201] *2021 INTERNATIONAL ENERGY CONSERVATION CODE (IECC) | ICC DIGITAL CODES* (IECC 2021), Table C403.3.2(6) <https://codes.iccsafe.org/content/IECC2021P2/chapter-4-ce-commercial-energy-efficiency>
- [202] U.S. Energy Information Administration, *2012 Commercial Buildings Energy Consumption Survey: Water Consumption in Large Buildings*, Table WD1. Daily water consumption in large commercial buildings, 2012
- [203] National Renewable Energy Laboratory, *Saving Energy in Commercial Buildings: Domestic Hot Water Assessment Guidelines*, Table 1. Hot Water Use By Building Type, June 2011.
- [204] Water Research Foundation: *Residential End Uses of Water, Version 2* (April 2016), Pg 5.
https://www.circleofblue.org/wp-content/uploads/2016/04/WRF_REU2016.pdf

3.11.6 PRE-RINSE SPRAY VALVES (PRSV)

Market	Commercial/Multifamily
Baseline Condition	RF/DI/TOS
Baseline	Existing/Dual
End Use Subcategory	Water Conservation
Measure Last Reviewed	December 2022

Description

This measure section documents the energy savings and demand reductions attributed to efficient low flow pre-rinse sprayers in grocery and food service applications including fast food restaurants, full-service restaurants, multifamily buildings, and other. *The most likely areas of application are kitchens in restaurants and hotels.*

Pre-rinse spray valves include a nozzle, squeeze lever, and dish guard bumper. The spray valves usually have a clip to lock the handle in the "on" position. Pre-rinse valves are inexpensive and easily interchangeable with different manufacturers' assemblies. The primary impacts of this measure are water savings. Energy savings depend on the facility's water heating fuel - if the facility does not have electric water heating, there are no electric savings for this measure; if the facility does not have fossil fuel water heating, there are no MMBtu (Therms) savings for this measure.

This measure is applicable to retrofit, Time of Sale, and DI applications.

Baseline Case

The baseline for the Retrofit/Early Replacement vintage is based on the EPA 2005 standard. Baseline flowrates are site specific. If unknown, they are assumed to be 1.6 gallons/minute.

Efficient Case

High efficiency PRSV with a flowrate less than the max flow rate by product class as defined by DOE/WaterSense.

Annual Energy Savings Algorithm

Annual Electric Energy Savings

$$\Delta kWh = N_{units} \times \frac{hours}{day} \times 60 \times \frac{days}{year} \times (GPM_b - GPM_q) \times 8.33 \times \frac{\Delta T}{E_{t,elec} \times 3,412}$$

Where,

$$\Delta T = T_{PRSV} - T_{Main}$$

Annual Fuel Savings

$$\Delta Therms = N_{units} \times \frac{hours}{day} \times 60 \times \frac{days}{year} \times (GPM_b - GPM_q) \times 8.33 \times \frac{\Delta T}{E_{t,fuel} \times 100,000}$$

Where,

$$\Delta T = T_{PRSV} - T_{Main}$$

Peak Demand Savings

$$\Delta kW_{Peak} = E_{TDF} \times Energy\ Savings$$

Daily Peak Fuel Savings

$$\Delta Therms_{Peak} = \Delta Therms \times PDF$$

Lifetime Energy Savings AlgorithmsLifetime Electric Energy Savings

$$\Delta kWh_{Life} = \Delta kWh \times EUL$$

Lifetime Fuel Savings

$$\Delta Therms_{Life} = \Delta Therms \times EUL$$

Dual:

Lifetime Electric Energy Savings

$$\Delta kWh_{Life} = \Delta kWh_{EREP} \times RUL + \Delta kWh_{NR} \times EUL$$

Lifetime Fuel Savings

$$\Delta Therms_{Life} = \Delta Therms_{EREP} \times RUL + \Delta Therms_{NR} \times EUL$$

Calculation Parameters

Table 3-343 Calculation Parameters

Variable	Description	Value	Units	Ref
ΔkWh	Annual electric energy savings	Calculated	kWh/yr	
$\Delta Therms$	Annual fuel savings	Calculated	Therms/yr	
ΔkW_{Peak}	Peak Demand Savings	Calculated	kW	
$\Delta Therms_{Peak}$	Daily peak fuel savings	Calculated	Therms/day	

Variable	Description	Value	Units	Ref
ΔT	Average temperature different between PRSV operating temperature and the supply water temperature	60	°F	[207][209]
N_{units}	Number of fixtures	Site-specific	N/A	
GPM_q	Flow rate of the installed prsv	Site-specific. If unknown, use 1.28	Gal/min	[214]
Days/year	Number of days the fixture is in use in one year	Site-specific. If unknown, look up in 3-344	Days/year	
$E_{t, \text{elec}}$	Thermal Efficiency for electrical heaters	Site-specific. If unknown, assume 98%	N/A	[215]
$E_{t, \text{fuel}}$	Thermal efficiency for fuel heaters	Site-specific. If unknown, assume 80%	N/A	[216]
ETDF	Energy to Demand Factor	Look up in Table 3-346	(kW/ kWh/yr)	[213]
GPM_b	Flow rate of the baseline prsv	Site-specific. If unknown, use 1.6	Gal/min	[205] [206]
Hours/day	Operating hours of fixture usage per day	Look up in Table 3-344	Hours/day	
8.33	Specific mass in pounds of one gallon of water	8.33	lbm/gal	
3,412	Btu to kWh electric conversion factor	3,412	Btu/kwh	
CF	Electric coincidence factor	Lookup in Table 3-347	N/A	
PDF	Gas peak day factor	Lookup in Table 3-347	N/A	
EUL	Effective useful life of new unit	See Measure Life Section	Years	
RUL	Remaining useful life of existing unit	See Measure Life Section	Years	

Table 3-344 Operating Hours/Day

Facility Type	Hours of Pre-Rinse Spray Value Use Per Day (hours)	Ref
Full Service Restaurant	4	[209]
Limited Service (fast food) Restaurant	1	[209]
Other	1.067	[210]

Table 3-345 Operating Days per Year

Building Type	Operating Days per Year	Building Type	Operating Days per Year
Education – Primary School	180	Education – Secondary School	210

Building Type	Operating Days per Year
Education – Community College	237
Education – University	192
Grocery	364
Medical – Hospital	364
Medical – Clinic	351
Lodging Hotel (Guest Rooms)	229
Lodging Motel	364
Manufacturing – Light Industrial	330
Office – Large	234
Office – Small	234
Restaurant – Sit-Down	364
Restaurant – Fast-Food	364
Retail – 3-Story Large	355
Retail – Single-Story Large	364
Retail – Small	364
Storage Conditioned	330
Storage Unconditioned	330
Warehouse	325
Average – Miscellaneous	303

Table 3-346 ETDf

Facility Type	ETDF
Quick-service Restaurant	0.000186
Full-Service Restaurant	0.0001189
Standalone Retail (Grocery)	0.000237
Default – Unknown	0.000259

Peak Factors**Table 3-347 Peak Factors**

Peak Factor	Value	Ref
Electric coincidence factor (CF)	N/A	
Natural gas peak day factor (PDF)	Appendix G: Natural Gas Peak Day Factors	

Measure Life

The remaining useful life (RUL) for existing equipment is limited to 1/3 of the effective useful life (EUL) of the equipment.

Table 3-348 Measure Life

Equipment	EUL	RUL	Ref
PRSV	5	1.67	[213]

References

- [205] The Energy Policy Act (EPA) of 2005. <http://www.psc.state.ga.us/electric/federal/EPA/EPA2005.pdf>
- [206] Impact and Process Evaluation Final Report for California Urban Water Conservation Council 2004-5 Pre-Rinse Spray Valve Installation Program (Phase 2), SBW Consulting, 2007, Table 3-4, p. 23. <https://p2infohouse.org/ref/50/49026.pdf>
- [207] *CEE Commercial Kitchens Initiative Program Guidance on Pre-Rinse Spray Valves*, (CEE 2005), pg. 3. <https://library.cee1.org/system/files/library/4252/PRSV%20Program%20Guidance.pdf>
- [208] Burch, J., and C. Christensen, *Towards Development of an Algorithm for Mains Water Temperature*. American Solar Energy Annual Conference Proceedings (2007).
- [209] Hours estimates based on PG&E savings estimates, algorithms, sources (2005). Food Service Pre-Rinse Spray Valves.

- [210] "WaterSense Specification for Commercial Pre-Rinse Spray Valves Supporting Statement" n.d. [WaterSense® Draft Specification for Commercial Pre-Rinse Spray Valves - Supporting Statement \(epa.gov\)](#)
- [211] "Federal Register :: Request Access." n.d. Unblock.federalregister.gov. Accessed December 8, 2022. <https://www.ecfr.gov/current/title-10/chapter-II/subchapter-D/part-430>
- [212] *Technical Reference Manual Volume 3: Commercial and Industrial Measures* Pg 138 (August 2019). <https://www.puc.pa.gov/filing-resources/issues-laws-regulations/act-129/technical-reference-manual/>
- [213] *Technical Support Document: Energy Efficiency Program For Consumer Products And Commercial And Industrial Equipment:Commercial Prerinse Spray Valves* (December 2015) Pg 8-13. <https://www.regulations.gov/document/EERE-2014-BT-STD-0027-0046>
- [214] EPA WaterSense Specification for Commercial Pre-Rinse Spray Valves. <https://www.epa.gov/watersense/pre-rinse-spray-valves>
- [215] *2022 Illinois Statewide Technical Reference Manual for Energy Efficiency Version 10.0: Volume 2* (2022), Pg 124, https://www.ilsag.info/wp-content/uploads/IL-TRM_Effective_010122_v10.0_Vol_2_C_and_I_09242021.pdf
- [216] ASHRAE Standards 90.1-2019, *Energy Standard for Buildings Except Low Rise Residential Buildings*. <https://www.ashrae.org/standards-research--technology/standards--guidelines>

3.11.7 RECIRCULATING PUMP CONTROL

Market	Commercial/Multifamily
Baseline Condition	RF/DI
Baseline	Existing/Dual
End Use Subcategory	Control
Measure Last Reviewed	December 2022

Description

This measure covers the installation of temperature modulation or demand controls on central domestic hot water (DHW) systems with recirculation:

- Temperature modulation controls reduce circulator pump energy and recirculation heat losses by modulating DHW system supply temperatures when hot water demand is expected to be low (usually based on occupancy schedules).
- Demand controls limit energy consumption by activating recirculation loops based on demand detected by a flow sensing device on the makeup water pipe and a temperature sensor installed on the recirculating return pipe.
- Temperature control. An aquastat control is used to switch the recirculating pump on and off to maintain a target temperature in the loop.
- Timer control. A timer is used to turn the recirculating pump on during peak usage times and off overnight.

Temperature modulation and demand controls achieve savings without significant interruptions to hot water availability. Recirculation systems are commonly used in larger buildings because the hot water must be quickly provided to spaces that are far from the water heating plant. The recirculation pump reduces wait time at the faucets by keeping the domestic hot water (DHW) piping loop hot as it gradually loses heat to the surrounding air. Without the recirculation pump, occupants would have to run their faucets until the cooled, stagnant water is removed from the piping between the faucet and the DHW plant and would waste water in the process; however, constant pumping operation increases energy consumption by exposing supply and return line piping to continuous heat loss, even in absence of the demand for hot water.

This measure is not applicable in facilities where twenty-four hour recirculation and delivered hot water temperature is required by code (refer to Section 7: Service Water Heating of ASHRAE 90.1 2019 to check for code requirements) [233]. This measure is not applicable to new construction or gut rehab installations.

Baseline Case

The base case for this measure category is existing, un-controlled recirculation pumps on central domestic hot water systems that continuously recirculates maintaining a constant supply temperature of the DHW.

Efficient Case

The efficient case is a central DHW recirculation system with a control system that regulates circulation pump operation based on demand and/or temperature or through timing and is in compliance with the current safety codes and standards in New Jersey.

Annual Energy Savings Algorithm

Annual Electric Energy Savings

$$\Delta kWh = \Delta kWh_{pump} + \Delta kWh_{HW}$$

Where,

$$\Delta kWh_{pump} = \frac{HP \times 0.746}{Eff_{pump}} \times LF \times Hrs_{Recirc,B} \times ESF_{pump}$$
$$\Delta kWh_{HW} = \frac{GPD \times 365 \times 8.33 \times (T_{Set} - T_{Main})}{3,412} \times \frac{F_{DHW,Elec}}{E_{T,Elec}} \times \frac{Hrs_{Recirc,B}}{8,760} \times ESF_{HW}$$

Annual Fuel Savings

$$\Delta Therms = \frac{GPD \times 365 \times 8.33 \times (T_{Set} - T_{Main})}{100,000} \times \frac{F_{DHW,Fuel}}{E_{T,Fuel}} \times \frac{Hrs_{Recirc,B}}{8,760} \times ESF_{HW}$$

Peak Demand Savings

$$\Delta kW_{Peak} = \frac{\Delta kWh}{Hrs_{Recirc,B}} \times CF$$

Daily Peak Fuel Savings

$$\Delta Therms_{Peak} = \Delta Therms \times PDF$$

Lifetime Energy Savings Algorithms:

Lifetime Electric Energy Savings

$$\Delta kWh_{Life} = \Delta kWh \times EUL$$

Lifetime Fuel Savings

$$\Delta Therms_{Life} = \Delta Therms \times EUL$$

Dual:

Lifetime Electric Energy Savings

$$\Delta kWh_{Life} = \Delta kWh_{EREP} \times RUL + \Delta kWh_{NR} \times EUL$$

Lifetime Fuel Savings

$$\Delta Therms_{Life} = \Delta Therms_{EREP} \times RUL + \Delta Therms_{NR} \times EUL$$

Calculation Parameters

Table 3-349 Calculation Parameters

Variable	Description	Value	Units	Ref
ΔkWh	Annual electric energy savings	Calculated	kWh/yr	
ΔkWh_{Pump}	Annual electric energy savings from pump	Calculated	kWh/yr	
ΔkWh_{HW}	Annual electric energy savings from hot water	Calculated	kWh/yr	
$\Delta Therms$	Annual fuel savings	Calculated	Therms/yr	
ΔkW_{Peak}	Peak Demand Savings	Calculated	kW	
$\Delta Therms_{Peak}$	Daily peak fuel savings	Calculated	Therms/day	
ΔkWh_{Life}	Lifetime electric energy savings	Calculated	kWh	
$\Delta Therms_{Life}$	Lifetime fuel savings	Calculated	Therms	
$Hrs_{Recirc, B}$	Annual hours of operation of recirculation system in baseline condition	Site-specific	Hrs/yr	
HP	Pump nameplate horsepower	Site-specific	HP	
Eff_{Pump}	Pump efficiency	Site-specific, if unknown look up in Table 3-350	N/A	
LF	Load factor	Site-specific, if unknown use 0.9	N/A	[219]
GPD	Average daily hot water usage	Site-specific, if unknown look up in Table 3-351	Gal/day	
T_{Set}	Water heater set point temperature	Site-specific, if unknown use 125	°F	[224]

Variable	Description	Value	Units	Ref
$E_{T, Fuel}$	Thermal efficiency of fossil fuel water heater	Site-specific, if unknown use 0.8	N/A	[228]
ESF_{HW}	Hot water energy savings factor	Look up in Table 3-353	N/A	[232]
$F_{DHW, Elec}$	Electric water heating factor	Look up in Table 3-352	N/A	
$F_{DHW, Fuel}$	Fossil fuel water heating factor	Look up in Table 3-352	N/A	
CF	Electric coincidence factor	Look up in Table 3-354	N/A	
PDF	Gas peak demand factor	Look up in Table 3-354	N/A	
T_{Main}	Supply water temperature in water main ¹⁴³	60	°F	[225]
$E_{T, Elec}$	Thermal efficiency of electric water heater	0.98	N/A	[231]
ESF_{Pump}	Pump energy savings factor	0.87	N/A	[230]
365	Days per year	365	Day/yr	
0.746	Unit conversion, kW/HP	0.746	kW/HP	
8.33	Unit conversion, Btu/gal·°F	8.33	Btu/gal·°F	
3,412	Unit conversion, Btu/kWh	3,412	Btu/kWh	
8,760	Unit conversion, Hrs/yr	8,760	Hrs/yr	
EUL	Effective useful life	See Measure Life Section	Years	
RUL	Remaining useful life of existing unit	See Measure Life Section	Years	

Table 3-350 Pump Efficiency

Pump Type	Value	Reference
PSC	0.60	[217]
ECM	0.80	[218]
Unknown	0.80	

¹⁴³ Average value across 5 NJ climate zones. Calculated from annual average ambient air temperature + 6°F.

Table 3-351 Average Daily Hot Water Usage

Building Type	GPD	Rate	Notes	Source	Reference
Assembly	239	7.02 GPD per 1,000 SF	Assumes 34,000 SF, 10% hot water	EIA: Public Assembly	[220]
Auto Repair	25	4.89 GPD per 1,000 SF	Assumes 5,150 SF, 10% hot water	EIA: Other	[220]
Big Box Retail	448	3.43 GPD per 1,000 SF	Assumes 130,500 SF, 10% hot water	EIA: Mercantile	[220]
Community College	1,520	1.9 GPD per person	Assumes 800 students	NREL School with Showers	[221]
Dormitory	8,600	17.2 GPD per resident	Assumes 500 residents	Water Research Foundation	[222]
Elementary School	250	0.5 GPD per student	Assumes 500 students	NREL: School	[221]
Fast Food Restaurant	500	500 GPD per restaurant		FSTC: Quick Service	[223]
Full-Service Restaurant	2,500	2,500 GPD per restaurant		FSTC: Full Service	[223]
Grocery	172	3.43 GPD per 1,000 SF	Assumes 50,000 SF, 10% hot water	EIA: Mercantile	[220]
High School	1,520	1.9 GPD per person	Assumes 800 students	NREL: School with Showers	[221]
Hospital	16,938	54.42 GPD per 1,000 SF		250,000 SF EIA: Health Care, Inpatient	[220]
Hotel	9,104	45.52 GPD per 1,000 SF	Assumes 40% hot water, 200,000 SF	EIA: Lodging	[220]
Large Office	550	1.1 GPD per person	Assumes 500 people	NREL: Office	[221]
Large Retail	446	3.43 GPD per 1,000 SF	Assumes 130,000 SF, 10% hot water	EIA: Mercantile	[220]
Light Industrial	489	4.89 GPD per 1,000 SF	Assumes 100,000 SF, 10% hot water	EIA: Other	[220]
Motel	1,366	45.52 GPD per 1,000 SF	Assumes 30,000 SF, 40% hot water	EIA: Lodging	[220]

Building Type	GPD	Rate	Notes	Source	Reference
Multifamily High-Rise	4,600	46 GPD per unit	Assumes 100 units	Water Research Foundation	[222]
Multifamily Low-Rise	552	46 GPD per unit	Assumes 12 units	Water Research Foundation	[222]
Refrigerated Warehouse	86	0.93 GPD per 1,000 SF	Assumes 92,000 SF, 10% hot water	EIA: Warehouse and Storage	[220]
Religious	77	7.02 GPD per 1,000 SF	Assumes 11,000 SF, 10% hot water	EIA: Public Assembly	[220]
Small Office	110	1.1 GPD per person	Assumes 100 people	NREL: Office	[221]
Small Retail	27	3.43 GPD per 1,000 SF	Assumes 8,000 SF, 10% hot water	EIA: Mercantile	[220]
University	1,000	0.5 GPD per student	Assumes 2,000 students	NREL: School	[221]
Warehouse	465	0.93 GPD per 1,000 SF	Assumes 500,000 SF, 10% hot water	EIA: Warehouse and Storage	[220]
Other	Calculate	4.89 GPD per 1,000 SF		EIA: Other	[220]

Table 3-352 Water Heating Factors

DHW System	$F_{DHW,Elec}$	$F_{DHW,Fuel}$
Electric	1.0	0.0
Fossil Fuel	0.0	1.0

Table 3-353 Hot Water Energy Savings Factors

Control Type	ESF_{HW}
Demand Control	0.07
Temperature Modulation	0.02
Demand Control and Temperature Modulation	0.15

Peak Factors

Table 3-354 Peak Factors

Peak Factor	Value	Ref
Electric coincidence factor (CF)	0.8	[229]
Natural gas peak day factor (PDF)	See Appendix G: Natural Gas Peak Day Factors	

Measure Life

The remaining useful life (RUL) for existing equipment is limited to 1/3 of the effective useful life (EUL) of the equipment.

Table 3-355 Measure Life

Equipment	EUL	RUL	Ref
Recirculating Pump	15	5	[232]

References

- [217] “Energy Savings Potential and Opportunities for High-Efficiency Electric Motors in Residential and Commercial Equipment.” 2013.
<https://www.energy.gov/sites/prod/files/2014/02/f8/Motor%20Energy%20Savings%20Potential%20Report%202013-12-4.pdf>.
- [218] “Comparing Motor Technologies – ACHR News.” N.d. WWW.achrnews.com.
<https://achrnews.com/articles/112674-comparing-motor-technologies>
- [219] Regional Technical Forum. Proposed Standard Savings Estimation Protocol for Ultra-Premium Efficiency Motors. November 5, 2012. Appendix C, Table 6. Average of values for 1, 1.5, and 2 hp pumps.
- [220] U.S. Energy Information Administration, 2012 Commercial Buildings Energy Consumption Survey: Water Consumption in Large Buildings, Table WD1. Daily water consumption in large commercial buildings, 2012
- [221] National Renewable Energy Laboratory, Saving Energy in Commercial Buildings: Domestic Hot Water Assessment Guidelines, Table 1. Hot Water Use By Building Type, June 2011
- [222] Water Research Foundation: Residential End Uses of Water, Version 2, April 2016
- [223] Food Service Technology Center, Design Guide – Energy Efficient Heating, Delivery and Use, Table 1. Typical hot water system cost for restaurants, March 2010 E
- [224] 10 CFR Appendix E to Subpart B of Part 430—Uniform Test Method for Measuring the Energy Consumption of Water Heaters, Section 2. Test Conditions, 2.5 Set Point Temperature.
- [225] Burch, Jay, and Craig Christensen. n.d. “TOWARDS DEVELOPMENT of an ALGORITHM for MAINS WATER TEMPERATURE.”
- [226] Code of Federal Regulations. 2022. Review of Title 10, Chapter II, Subchapter D, Part 431. Appendix B to Subpart G of Part 431 - Uniform Test Method for the Measurement of Standby Loss of Electric Storage Water

Heaters and Storage-Type Instantaneous Water Heaters, eCFR. December 1, 2022.
<https://www.ecfr.gov/current/title-10/chapter-II/subchapter-D/part-431/subpart-G>

- [227] 2022 California Public Utilities Commission. n.d. Review of DEER Resources - Water Heater - DEER Water Heater Calculator. Cedars - California Energy Data and Reporting System. <https://cedars.sound-data.com/deer-resources/tools/water-heaters/>.
- [228] ASHRAE Standard 90.1-2019, Energy Standard for Buildings Except Low-Rise Residential Buildings. (ASHRAE, 2019), Table 7.8, <https://www.ashrae.org/technical-resources/standards-and-guidelines/read-only-versions-of-ashrae-standards>
- [229] "New York Standard Approach for Estimating Energy Savings from Energy Efficiency Programs V10 (2023) Pg 612
[https://www3.dps.ny.gov/W/PSCWeb.nsf/96f0fec0b45a3c6485257688006a701a/72c23deccff52920a85257f1100671bdd/\\$FILE/NYS%20TRM%20V10.pdf](https://www3.dps.ny.gov/W/PSCWeb.nsf/96f0fec0b45a3c6485257688006a701a/72c23deccff52920a85257f1100671bdd/$FILE/NYS%20TRM%20V10.pdf)
- [230] Center for Energy and Environment, Evaluation of New DHW System Controls in Hospitality and Commercial Buildings. (2018), pg 12, <https://mn.gov/commerce-stat/pdfs/card-dhw-system-controls.pdf>
- [231] 10 CFR 430 Subpart B Appendix E – Uniform Test Method for Measuring the Energy Consumption of Water Heaters: 6.3.2 *Recovery Efficiency*
- [232] NREL, Control Strategies to Reduce the Energy Consumption of Central Domestic Hot Water Systems, June 2016, <https://www.nrel.gov/docs/fy16osti/64541.pdf>
- [233] ASHRAE Standard 90.1-2019, Energy Standard for Buildings Except Low-Rise Residential Buildings. (ASHRAE, 2019), Section 7: Service Water Heating Pg 151, <https://www.ashrae.org/technical-resources/standards-and-guidelines/read-only-versions-of-ashrae-standards>

3.11.8 PIPE INSULATION

Market	Commercial/Multifamily
Baseline Condition	RF/DI
Baseline	Existing
End Use Subcategory	Insulation
Measure Last Reviewed	November 2022

Description

This measure covers the installation of fiberglass, rigid foam, and cellular glass pipe insulation on exposed and uninsulated metal or steel piping with a nominal diameter between 0.50” and 8.00” for hot water and steam type space heating and/or domestic hot water (DHW) distribution systems in commercial, industrial, and multifamily high-rise buildings. The measure is restricted to insulation of hot water distribution pipe in conditioned and unconditioned spaces. Space heating pipe insulation is limited to insulation installed in unheated spaces only. Insulation of CPVC, PEX, and HDPE piping is not eligible for savings under this measure due to low potential of savings.

In New Jersey, the current state energy code (ASHRAE 90.1 2019 in 2023) defines the energy code standards for buildings except low rise residential. Hence, this has been used to define default thermal efficiencies of heating systems. However, when it does not include service water heating provisions, it leaves federal equipment efficiency standards to define baseline.

This measure caters for all insulation types given that they are ASHRAE 90.1 2019 code compliant and are installed by certified professionals. The R-value of an insulation is the thermal resistance of its constituent material, which is derived by dividing the thickness of the material by the material’s thermal conductivity, or k-value. Thermal transmittance, or the material’s U-factor, is the inverse of the R-value.

Baseline Case

The baseline condition is bare copper (metal) or steel domestic hot water or space heating piping in an unconditioned space.

Efficient Case

An insulated pipe in an unconditioned spaced conforming to the requirements of ASHRAE 2019 Section 6.8.3, Table 3-1.

Annual Energy Savings Algorithm

Annual Electric Energy Savings

$$\Delta kWh = \frac{\left[\left(\frac{UA}{L} \right)_b - \left(\frac{UA}{L} \right)_q \right] \times L \times (T_{pipe} - T_{amb}) \times hrs \times SF_{elec}}{Et_{elec} \times 3,412}$$

Annual Fuel Savings

$$\Delta Therms = \frac{\left[\left(\frac{UA}{L} \right)_b - \left(\frac{UA}{L} \right)_q \right] \times L \times (T_{pipe} - T_{amb}) \times hrs \times SF_{fuel}}{Et_{fuel} \times 100,000}$$

Peak Demand Savings

$$\Delta kW_{Peak} = \frac{\Delta kWh}{8,760} \times CF$$

Daily Peak Fuel Savings

$$\Delta Therms_{Peak} = \Delta Therms \times PDF$$

Lifetime Energy Savings Algorithms

Lifetime Electric Energy Savings

$$\Delta kWh_{Life} = \Delta kWh \times EUL$$

Lifetime Fuel Savings

$$\Delta Therms_{Life} = \Delta Therms \times EUL$$

Calculation Parameters

Table 3-356 Calculation Parameters

Variable	Description	Value	Units	Ref
ΔkWh	Annual electric energy savings	Calculated	kWh/yr	
$\Delta Therms$	Annual fuel savings	Calculated	Therms/yr	
ΔkW_{Peak}	Peak Demand Savings	Calculated	kW	
$\Delta Therms_{Peak}$	Daily peak fuel savings	Calculated	Therms/day	
ΔkWh_{life}	Lifetime electric energy savings	Calculated	kWh	
$\Delta Therms_{life}$	Lifetime fuel savings	Calculated	Therms	
L	Length of installed insulation	Site-specific	ft	
T_{pipe}	Average temperature of hot water or steam in distribution system piping	Site-specific, if unknown lookup in Table 3-361	°F	[237][238][241]
T_{amb}	Surrounding average ambient air temperature	Site-specific, if unknown: DHW: 70 Space Heat: 50	°F	[245]
E_{fuel}	Recovery Efficiency of fuel water heaters or AFUE of boiler for space heating	Site-specific, if unknown: DHW ¹⁴⁴ : 0.8 Space Heating Boilers: Lookup in Table 3-359	N/A	[242][243]
E_{elec}	Recovery Efficiency of electric water heaters	Site-specific, if unknown: Non-Heat Pump DHW ¹⁴⁵ : 0.98 Heat Pump DHW: Lookup in Table 3-360	N/A	[273][236]
hrs	Equivalent full load heating hours	Site-specific, if unknown: DHW: 8,760 Boilers: Lookup heating EFLH in Appendix C:	hrs	[209][209]

¹⁴⁴ The 80% default assumption comes from most ASHRAE 90.1 2019 minimum thermal efficiencies listed for water heater.

¹⁴⁵ ASHRAE 90.1 2019 does not list thermal efficiencies for electric water heaters. Instead it references UEF values for the respective classes. The 98% assumption comes from the Code of Federal regulations. The 98% default value should not be used for heat pump water heaters.

Variable	Description	Value	Units	Ref
		Heating and Cooling EFLH		
$(UA/L)_b$	Product of Overall Heat Transfer Coefficient and Pipe Area (UA) per foot from uninsulated pipe ¹⁴⁶	Lookup in Table 3-357	Btu/hr-°F-ft	[239]
$(UA/L)_q$	Product of Overall Heat Transfer Coefficient and Pipe Area (UA) per foot from insulated pipe ¹⁴⁶	Lookup in Table 2-187	Btu/hr-°F-ft	[247]
SF_{elec}	Adjustment to electric water heating energy savings when water heating fuel is unknown	Electric WH: 1.0 Unknown WH: 0.55	N/A	[240]
SF_{fuel}	Adjustment to fossil fuel water heating energy savings based on water heating fuel ^f	Fossil Fuel WH & Space Heating: 1.0 Unknown WH: 0.56	N/A	[240]
CF	Electric coincidence factor	Lookup in Table 3-132	N/A	
PDF	Gas peak day factor	Lookup in Table 3-132	N/A	
EUL	Effective useful life	See Measure Life section	Years	

Table 3-357 Product of Overall Heat Transfer Coefficient and Pipe Area per foot from Uninsulated Pipe $(UA/L)_b$

Nominal Pipe Size (in)	Bare Copper Piping			Bare Steel Piping	
	Domestic Hot Water	Hot Water Heat	Steam Heat	Hot Water Heat	Steam Heat
0.50	0.44	0.48	0.53	0.53	0.59
0.75	0.54	0.58	0.64	0.65	0.72
1.00	0.65	0.70	0.78	0.79	0.88
1.25	0.80	0.86	0.96	0.97	1.09
1.50	0.90	0.97	1.09	1.10	1.23
2.00	1.10	1.19	1.33	1.34	1.51
2.50	1.31	1.42	1.58	1.60	1.80
3.00	1.57	1.70	1.90	1.92	2.16
3.50	1.77	1.92	2.15	2.18	2.45
4.00	1.98	2.14	2.40	2.43	2.73

¹⁴⁶ Also called Building Load Coefficient per unit length

Nominal Pipe Size (in)	Bare Copper Piping			Bare Steel Piping	
	Domestic Hot Water	Hot Water Heat	Steam Heat	Hot Water Heat	Steam Heat
5.00	2.41	2.61	2.92	2.97	3.34
6.00	2.84	3.07	3.45	3.50	3.94
8.00	3.64	3.94	4.42	4.50	5.06

Table 3-358 Product of Overall Heat Transfer Coefficient and Pipe Area per foot from Insulated Pipe (UA/L)_q

Nominal Pipe Size (in)	Fiberglass						Rigid Foam/Cellular Glass					
	0.5 in	1 in	1.5 in	2 in	2.5 in	3 in	0.5 in	1 in	1.5 in	2 in	2.5 in	3 in
0.50	0.13	0.09	0.08	0.07	0.06	0.06	0.15	0.12	0.10	0.09	0.09	0.08
0.75	0.14	0.11	0.09	0.08	0.07	0.07	0.17	0.13	0.11	0.10	0.10	0.09
1.00	0.17	0.12	0.10	0.09	0.08	0.07	0.19	0.15	0.13	0.12	0.11	0.10
1.25	0.20	0.14	0.11	0.10	0.09	0.08	0.23	0.17	0.15	0.13	0.12	0.11
1.50	0.22	0.15	0.12	0.11	0.10	0.09	0.25	0.19	0.16	0.14	0.13	0.12
2.00	0.26	0.18	0.14	0.12	0.11	0.10	0.29	0.22	0.18	0.16	0.14	0.13
2.50	0.30	0.20	0.16	0.14	0.12	0.11	0.34	0.25	0.20	0.18	0.16	0.15
3.00	0.35	0.24	0.18	0.16	0.14	0.12	0.39	0.29	0.23	0.20	0.18	0.16
3.50	0.40	0.26	0.20	0.17	0.15	0.13	0.44	0.32	0.26	0.22	0.20	0.18
4.00	0.44	0.29	0.22	0.18	0.16	0.14	0.48	0.35	0.28	0.24	0.21	0.19
5.00	0.52	0.34	0.26	0.22	0.19	0.17	0.58	0.41	0.33	0.28	0.25	0.22
6.00	0.61	0.39	0.30	0.25	0.21	0.19	0.67	0.47	0.37	0.32	0.28	0.25
8.00	0.77	0.49	0.37	0.30	0.26	0.23	0.84	0.59	0.46	0.39	0.34	0.30

Table 3-359 Gas- and Oil-Fired Boilers—Minimum Efficiency Requirements

Equipment Type	Subcategory or Rating Condition	Size Category (Input)	Efficiency as of 3/2/2022	Test Procedure
Boilers, hot water	Gas fired	<300,000 Btu/h	82% AFUE	10 CFR 430 Appendix N
		≥300,000 Btu/h and ≤2,500,000 Btu/h	80% Et	10 CFR 431.86
		>2,500,000 Btu/h	82% Ec	

Equipment Type	Subcategory or Rating Condition	Size Category (Input)	Efficiency as of 3/2/2022	Test Procedure
	Oil fired	<300,000 Btu/h	84% AFUE	10 CFR 430 Appendix N
		≥300,000 Btu/h and ≤2,500,000 Btu/h	82% Et	10 CFR 431.86
		>2,500,000 Btu/h	84% Ec	
Boilers, steam	Gas fired	<300,000 Btu/h	80% AFUE	10 CFR 430 Appendix N
	Gas fired—all, except natural draft	≥300,000 Btu/h and ≤2,500,000 Btu/h	79% Et	10 CFR 431.86
		>2,500,000 Btu/h	79% Et	
	Gas fired—natural draft	≥300,000 Btu/h and ≤2,500,000 Btu/h	79% Et	
		>2,500,000 Btu/h	79% Et	
	Oil fired	<300,000 Btu/h	82% AFUE	10 CFR 430 Appendix N
		≥300,000 Btu/h and ≤2,500,000 Btu/h	81% Et	10 CFR 431.86
		>2,500,000 Btu/h	81% Et	

Table 3-360 Default Heat Pump Water Heater COPs and UEF by Tank Storage Capacity

Size (Gallons)	UEF	Calculated COP
50	3.30	2.83
50	3.50	2.92
50	3.75	3.14
65	3.30	2.85
65	3.50	2.94
65	3.75	3.24
80	3.30	2.85
80	3.50	3.01
80	3.75	3.38
Unknown Size ¹⁴⁷	-	3.016

¹⁴⁷ Unknown COP is the average of storage tank heat pump water heater's COP for medium to high draw types covering a storage capacity range of 50 gallons to 80 gallons taken from California Energy Data and Reporting System's DEER Water Heater Calculator [236]

Table 3-361 Average Temperature of Hot Water or Steam in Distribution System Piping

System Type	Facility Type	Pipe Temperature °F
Hot Water	Commercial	138
Hot Water	Industrial	134
Low Pressure Steam ¹⁴⁸	C&I	240
Medium Pressure Steam	Commercial	304
Medium Pressure Steam	Industrial	258

Peak Factors

Table 3-362 Peak Factors

Peak Factor	Value	Ref
Electric coincidence factor (CF)	Electric DHW: 1.0 Hot Water: N/A	
Natural gas peak day factor (PDF)	See Appendix G: Natural Gas Peak Day Factors	

Measure Life

The effective useful life (EUL) is 13 years for electric water heaters and 11 years for gas water heaters [248].

References

- [234] “2022 Illinois Statewide Technical Reference Manual for Energy Efficiency.” 2021, Page 88. https://www.ilsag.info/wp-content/uploads/IL-TRM_Effective_010122_v10.0_Vol_3_Res_09242021.pdf
- [235] “Pipe Sizing Charts Tables | Energy-Models.com.” 2013. Energy-Models.com. 2013. <https://energy-models.com/pipe-sizing-charts-tables>.
- [236] 2022 California Public Utilities Commission. n.d. Review of DEER Resources - Water Heater - DEER Water Heater Calculator. Cedars - California Energy Data and Reporting System. <https://cedars.sound-data.com/deer-resources/tools/water-heaters/>.

¹⁴⁸ Average of 2014 and 2015 values of the Low Pressure Steam related pipe temperature values in the ‘NONRESIDENTIAL DOWNSTREAM ESPI DEEMED PIPE INSULATION IMPACT EVALUATION’ studies by Ltron Inc and ERS [237].

- [237] Ltron & ERS. 2016. Review of 2014 Nonresidential Downstream Deemed ESPI Pipe Insulation Impact Evaluation Report. California Public Utilities Commission. March 29, 2016. https://www.caetrm.com/media/reference-documents/ltron_2016_ESPI_Pipe_Insulation_Report_FINAL_20160329.pdf.
- [238] Ltron & ERS. 2017. Review of 2015 NONRESIDENTIAL DOWNSTREAM ESPI DEEMED PIPE INSULATION IMPACT EVALUATION. California Public Utilities Commission. March 31, 2017. https://www.caetrm.com/media/reference-documents/2015_Nonresidential_Downstream_ESPI_DEEMED_Pipe_Insulation_Impact_Ev_cr3XPvt.pdf.
- [239] New York Standard Approach for Estimating Energy Savings from Energy Efficiency Programs – Version 9. (New York State Joint Utilities, 2021), Pg 508, [https://www3.dps.ny.gov/W/PSCWeb.nsf/96f0fec0b45a3c6485257688006a701a/72c23defff52920a85257f1100671bdd/\\$FILE/NYS%20TRM%20V9.pdf](https://www3.dps.ny.gov/W/PSCWeb.nsf/96f0fec0b45a3c6485257688006a701a/72c23defff52920a85257f1100671bdd/$FILE/NYS%20TRM%20V9.pdf)
- [240] NREL. 2022. Review of US Commercial Sector circa 2018. ComStock. October 2021. https://comstock.nrel.gov/dataviewer/building-characteristics/?datasetName=vizstock_comstock_amy2018_release_1_by_state_vu&locationId=NJ
- [241] Southern California Gas Company (SCG). 2017. WPSCGWP110812A_Rev4__ltron_2014_2015 WP Parameters.xlsx https://view.officeapps.live.com/op/view.aspx?src=https%3A%2F%2Fwww.caetrm.com%2Fmedia%2Freference-documents%2FWPSCGWP110812A_Rev4_ltron_2014_2015_WP_Parameters.xlsx&wdOrigin=BROWSELINK
- [242] ASHRAE Standard 90.1-2019, Energy Standard for Buildings Except Low-Rise Residential Buildings. (ASHRAE, 2019), Table 7.8, <https://www.ashrae.org/technical-resources/standards-and-guidelines/read-only-versions-of-ashrae-standards>
- [243] ASHRAE Standard 90.1-2019, Energy Standard for Buildings Except Low-Rise Residential Buildings. (ASHRAE, 2019), Table 6.8.1-6, <https://www.ashrae.org/technical-resources/standards-and-guidelines/read-only-versions-of-ashrae-standards>
- [244] Code of Federal Regulations. 2022. Review of Title 10, Chapter II, Subchapter D, Part 431. Appendix B to Subpart G of Part 431 - Uniform Test Method for the Measurement of Standby Loss of Electric Storage Water Heaters and Storage-Type Instantaneous Water Heaters, eCFR. December 1, 2022. <https://www.ecfr.gov/current/title-10/chapter-II/subchapter-D/part-431/subpart-G>
- [245] New York Standard Approach for Estimating Energy Savings from Energy Efficiency Programs – Version 9. (New York State Joint Utilities, 2021), Pg 506 [https://www3.dps.ny.gov/W/PSCWeb.nsf/96f0fec0b45a3c6485257688006a701a/72c23defff52920a85257f1100671bdd/\\$FILE/NYS%20TRM%20V9.pdf](https://www3.dps.ny.gov/W/PSCWeb.nsf/96f0fec0b45a3c6485257688006a701a/72c23defff52920a85257f1100671bdd/$FILE/NYS%20TRM%20V9.pdf) <https://www.ecfr.gov/current/title-10/chapter-II/subchapter-D/part-430/subpart-C/section-430.32>
- [246] Simulations of prototype buildings from NY TRM updated with NJ weather done by NJ Statewide Evaluator, May 2022
- [247] New York Standard Approach for Estimating Energy Savings from Energy Efficiency Programs – Version 9. (New York State Joint Utilities, 2021), Pg 509, [https://www3.dps.ny.gov/W/PSCWeb.nsf/96f0fec0b45a3c6485257688006a701a/72c23defff52920a85257f1100671bdd/\\$FILE/NYS%20TRM%20V9.pdf](https://www3.dps.ny.gov/W/PSCWeb.nsf/96f0fec0b45a3c6485257688006a701a/72c23defff52920a85257f1100671bdd/$FILE/NYS%20TRM%20V9.pdf)
- [248] California Public Utilities Commission EUL Table, version 027 (updated November 12, 2022). Accessed December 30, 2022. <https://www.caetrm.com/shared-data/value-table/EUL/>

3.12 PROCESS

3.12.1 VSD AIR COMPRESSORS

Market	Commercial and Industrial
Baseline Condition	TOS/NC
Baseline	Code
End Use Subcategory	Compressed Air
Measure Last Reviewed	December 2022

Description

Variable-Speed Drive (VSD) Air Compressors use a variable speed drive on the motor to match motor output to the load, resulting in greater efficiency than fixed-speed air compressors. Baseline compressors choke off inlet air to modulate the compressor output, resulting in increased energy consumption and peak demand. This measure relates to the installation of a new air compressor of 100 HP or less with a variable speed drive. Projects involving compressors larger than 100 HP should be treated as custom projects.

Baseline Case

The baseline condition is a typical load/unload compressor.

Efficient Case

A screw compressor with variable speed control on the motor to match output to the load.

Annual Energy Savings Algorithm

Annual Electric Energy Savings

$$\Delta kWh = 0.9 \times HP \times Hrs \times (COMP_b - COMP_q)$$

Annual Fuel Savings

$$\Delta Therms = N/A$$

Peak Demand Savings

$$\Delta kW_{Peak} = \frac{\Delta kWh}{Hrs} \times CF$$

Daily Peak Fuel Savings

$$\Delta Therms_{Peak} = N/A$$

Lifetime Energy Savings Algorithms

Lifetime Electric Energy Savings

$$\Delta kWh_{Life} = \Delta kWh \times EUL$$

Lifetime Fuel Savings

$$\Delta Therms_{Life} = N/A$$

Calculation Parameters

Table 3-363 Calculation Parameters

Variable	Description	Value	Units	Ref
ΔkWh	Annual electric energy savings	Calculated	kWh/yr	
ΔkW_{Peak}	Peak Demand Savings	Calculated	kW	
ΔkWh_{Life}	Lifetime electric energy savings	Calculated	kWh	
HP	Compressor motor nominal HP	Site-specific	hp	
COMP _b	Baseline compressor factor	Look up in Table 3-365	N/A	[249]
COMP _q	Installed compressor factor, actual	Site-specific, if unknown use 0.705	N/A	[249]
Hrs	Compressor total hours of operation	Site-specific, if unknown look up in Table 3-364	Hrs/yr	[249]
CF	Coincidence factor	Look up in Table 3-364	N/A	[249]
PDF	Gas peak demand factor	Look up in Table 3-366	N/A	
0.9	Compressor motor nominal hp to full load kW Conversion factor	0.9	N/A	[249]
EUL	Effective useful life of new unit	See Measure Life Section	Years	

Table 3-364 Compressor Total Hours of Operation and Coincidence Factors

Number of Shifts	Description	Annual Operating Hours	Coincidence Factor (CF)
Single shift	7 AM – 3 PM, weekdays, minus holidays and scheduled down time	1,976	0.59
2 - shift	7AM – 11 PM, weekdays, minus holidays and scheduled down time	3,952	0.95
3 - shift	24 hours per day, weekdays, minus holidays and scheduled down time	5,928	0.95
4 - shift	24 hours per day, 7 days a week minus holidays and scheduled down time	8,320	0.95

Table 3-365 Baseline Compressor Factor

Baseline Compressor	Compressor Factor COMP _b
Modulating w/ Blowdown	0.890
Load/No Load w/ 1 Gallon-of-storage/ CFM _{Max}	0.909
Load/No Load w/ 3 Gallon-of-storage/ CFM _{Max}	0.831
Load/No Load w/ 5 Gallon-of-storage/ CFM _{Max}	0.806

Peak Factors**Table 3-366 Peak Factors**

Peak Factor	Value	Ref
Electric coincidence factor (CF)	Look up in Table 3-364	[249]
Natural gas peak day factor (PDF)	N/A	

Measure Life

The effective useful life (EUL) is 13 years [250].

References

[249] *Mid Atlantic Technical Reference Manual Version 10.0*, (2020), <https://neep.org/mid-atlantic-technical-reference-manual-trm-v10> Compressor factors were developed using DOE part load data for different compressor control types as well as load profiles from 50 facilities employing air compressors less than or equal to 40 hp, as sourced from the Efficiency Vermont TRM. (The “variable speed drive” compressor factor has been adjusted up from the 0.675 presented in the analysis to 0.705 to account for the additional power draw of the VSD).

[250] *California Public Utilities Commission EUL Table, version 027 (updated November 12, 2022)*. Accessed December 30, 2022. <https://www.caetrm.com/shared-data/value-table/EUL/>

3.12.2 COMPRESSED AIR LEAK DETECTION

Market	Commercial
Baseline Condition	RF
Baseline	Existing
End Use Subcategory	Maintenance
Measure Last Reviewed	March 2023

Description

This measure presents energy savings associated with reducing compressed air losses through ultrasonic leak detection and the repair of compressed air leaks.

Baseline Case

Industrial compressed air system with suspected leaks.

Efficient Case

Compressed air system with identified and repaired leaks.

Annual Energy Savings Algorithms

Annual Electric Energy Savings

$$\Delta kWh = N_{leaks} \times CFM_{leaks} \times Eff_{comp} \times Hrs \times F_{control}$$

Annual Fuel Savings

$$\Delta Therms = N/A$$

Peak Demand Savings

$$\Delta kW_{Peak} = \frac{\Delta kWh}{Hrs} \times CF$$

Daily Peak Fuel Savings

$$\Delta Therms_{Peak} = N/A$$

Lifetime Energy Savings Algorithms

Lifetime Electric Energy Savings

$$\Delta kWh_{Life} = \Delta kWh \times EUL$$

Lifetime Fuel Savings

$$\Delta Therms_{Life} = \Delta Therms \times EUL$$

Calculation Parameters

Table 3-367 Calculation Parameters

Variable	Description	Value	Units	Ref
ΔkWh	Annual electric energy savings	Calculated	kWh/yr	
ΔkW_{Peak}	Peak Demand Savings	Calculated	kW	
ΔkWh_{Life}	Lifetime electric energy savings	Calculated	kWh	
N_{leaks}	Number of leaks repaired	Site-specific	N/A	
Hrs	Hours of operation per year	Site-specific, if unknown use 6,240	Hrs/yr	[5]
CFM_{leak}	CFM loss per leak	Site-specific, look up in Table 3-368	CFM	[1]
Eff_{comp}	Compressor efficiency	Site-specific, if unknown look up in Table 3-369	kW/CFM	[2]
$F_{control}$	Control factor, percent kW divided by percent load	Look up in Table 3-370	N/A	[3]
CF	Electric coincidence factor	Look up in Table 3-132	N/A	[4]
PDF	Gas peak day factor	Look up in Table 3-132	N/A	
EUL	Effective useful life	See Measure Life section	Years	

Table 3-368 CFM per Leak Size and Compressed Air Pressure

Pressure (psig)	Orifice Diameter (inches)					
	1/64	1/32	1/16	1/8	1/4	3/8
70	0.3	1.2	4.8	19.2	76.7	173
80	0.33	1.3	5.4	21.4	85.7	193
90	0.37	1.5	5.9	23.8	94.8	213

Pressure (psig)	Orifice Diameter (inches)					
	1/64	1/32	1/16	1/8	1/4	3/8
100	0.41	1.6	6.5	26	104	234
125	0.49	2	7.9	31.6	126	284

Table 3-369 Default Compressor Efficiencies

Compressor Type	Efficiency (kW/CFM)
Single-acting reciprocating air compressor	0.23
Double-acting reciprocating air compressor	0.155
Lubricant-injected rotary screw compressor	0.185
Lubricant-free rotary screw compressor	0.2
Centrifugal compressor	0.18
Average	0.19

Table 3-370 Efficiency Factors per Control Type

Control Type	Fcontrol (% kW / % load)
Inlet valve modulated	0.31
Variable displacement	0.69
Variable speed drive	0.85

Peak Factors

Table 3-371 Peak Factors

Peak Factor	Value	Ref
Electric coincidence factor (CF)	0.846	[4]
Natural gas peak day factor (PDF)	See Appendix G: Natural Gas Peak Day Factors	

Measure Life

The effective useful life (EUL) is 1 year. [6]

References

- [1] "Energy Tips: Minimize Compressed Air Leaks"
http://www.energystar.gov/ia/business/industry/compressed_air3.pdf.
- [2] Data from Compressed Air Challenge "Fundamentals of Compressed Air Systems" Pgs. 28-32
- [3] Data extrapolated from Compressed Air Challenge "Fundamentals of Compressed Air Systems" Pg. 90-91
- [4] KEMA, New Jersey's Clean Energy Program Energy Impact Evaluation and Protocol Review, July 10, 2009.
- [5] This is based on 3 shifts per day, 5 days per week. This figure is supported by a survey of previous compressed air projects within Michigan and Ohio energy efficiency programs.
- [6] One year measure life is based on typical recommendation of annual leak survey.

3.13 WHOLE BUILDING

3.13.1 COMBINED HEAT AND POWER

Market	Commercial
Baseline Condition	NC/RF
Baseline	Code/Existing
End Use Subcategory	HVAC
Measure Last Reviewed	March 2023

Description

This measure applies to the installation of Combined Heat and Power (CHP) System in a commercial setting, defined as a system that sequentially generates both electrical energy and useful thermal energy from one fuel source. Eligible systems include: powered by non-renewable or renewable fuel sources, gas internal combustion engine, gas combustion turbine, microturbine, steam turbine, and fuel cells.

The measurement of energy and savings for CHP systems is based primarily on the characteristics of the individual systems subject to the general principles set out below. The majority of the inputs used to estimate energy and demand impacts of CHP systems will be drawn from individual project applications.

The methodology presented in the measure is based on the National Renewable Energy Laboratory's Combined Heat and Power, The Uniform Methods Project: Methods for Determining Energy- Efficiency Savings for Specific Measures [1]. If a CHP system cannot be evaluated using the methodology in this measure (due to complexity of the system or other factors), the project may be evaluated using a custom engineering analysis.

CHP systems typically use fossil fuels to generate electricity that displaces electric generation from other sources. Therefore, the electricity generated from a CHP system should not be reported as either electric energy savings or renewable energy generation. Exceptions may be made to this standard, such as CHP systems that use an absorption chiller to convert useful heat to cooling energy, and thus operates in the summer; or cases where the CHP system generates more electricity than consumed and is allowed to export electricity to the grid. Alternatively, electric generation and capacity from CHP systems should be reported as Distributed Generation (DG) separate from energy savings and renewable energy generation. However, any waste heat recaptured and utilized should be reported as energy savings as discussed below.

Baseline Case

If the CHP system is replacing or adding on to an existing HVAC system, the baseline is the site-specific existing equipment. If the CHP system uses an absorption chiller, the baseline equipment is assumed to be a code-compliant electric chiller. For new construction, the baseline scenario is a standalone (no power generation) code-compliant HVAC system of the same capacity and fuel as the CHP system.

Efficient Case

The efficient case is the installed CHP system, defined as a system that sequentially generates both electrical energy and useful thermal energy from one fuel source. Eligible systems include: powered by non-renewable or renewable fuel sources, gas internal combustion engine, gas combustion turbine, microturbine, steam turbine, and fuel cells with and without heat recovery.

Annual Energy Savings Algorithms

Note: The algorithms presented below are simplified. Users should adopt a level of rigor that matches the program needs and available data. As long as the energy impacts are calculated in an equivalent manner, alternative methodologies such as conducting a site-specific hourly/daily analysis are acceptable.

Annual Electric Energy Savings

$$\Delta kWh = kWh_{Net} + kWh_{ChillerOffset}$$

Where,

$$kWh_{Net} = kWh_{Gross} - kWh_{Consumed}$$

$$kWh_{ChillerOffset} = kWh_{Net} \times UHRR_c \times COP \times \frac{Eff_{ElecChiller}}{12} \text{ (if CHP is driving an absorption chiller)}$$

$$UHRR_c = \frac{UHR_c}{kWh_{Net}}$$

$$kWh_{ChillerOffset} = 0 \text{ (if no absorption chiller is involved)}$$

Annual Fuel Savings

$$\Delta Therms = \frac{Fuel_{Offset} - Fuel_{Consumed}}{100}$$

Where,

$$Fuel_{Offset} = \frac{kWh_{Net} \times UHRR_H}{Eff_{Boiler}}$$

$$Fuel_{Consumed} = \frac{kWh_{Gross}}{Eff_{NetElec}} \times 3.412$$

$$UHRR_h = \frac{UHR_h}{kWh_{Net}}$$

$$Eff_{NetElec} = \frac{\Delta kWh \times 3.412}{Fuel_{input}}$$

Annual Peak Demand Savings

Calculation of peak demand savings requires site-specific hourly analysis. See UMP: Section 3.1 Determining Electricity Impacts Pg 11 for more detail.

Daily Peak Fuel Savings

Calculation of peak fuel savings requires site-specific hourly analysis. See UMP: Section 3.2 Determining Fuel Impacts Pg 12 for more detail.

Lifetime Energy Savings Algorithms

Lifetime Electric Energy Savings

$$\Delta kWh_{Life} = \Delta kWh \times EUL$$

Lifetime Fuel Savings

$$\Delta Therms_{Life} = \Delta Therms \times EUL$$

Calculation Parameters

Table 3-372 Calculation Parameters

Variable	Description	Value	Units	Ref
ΔkWh	Annual electric energy savings	Calculated	kWh/yr	
$\Delta Therms$	Annual fuel savings	Calculated	Therms/yr	
ΔkW_{Peak}	Annual peak demand savings	Calculated	kW	
$\Delta Therms_{Peak}$	Daily peak fuel savings	Calculated	Therms/day	
ΔkWh_{Life}	Lifetime electric energy savings	Calculated	kWh	
$\Delta Therms_{Life}$	Lifetime fuel savings	Calculated	Therms	
$Fuel_{Offset}$	Reduction in fuel consumption that would have been used for heating that can be attributed to the CHP system	Calculated	kBtu	
$Fuel_{Consumed}$	Utility delivered fuel consumed by CHP system	Calculated	kBtu	
$Eff_{NetElec}$	Net electrical efficiency, a measure of how much of the energy in the fuel input is converted to net electricity	Calculated	N/A	
$UHRR_C$	Useful heat recovery rate for absorption chiller	Calculated	kBtu/kWh	
$UHRR_h$	Useful heat recovery rate associated with heating offset	Calculated	kBtu/kWh	

Variable	Description	Value	Units	Ref
$kWh_{\text{ChillerOffset}}$	Annual electrical energy offset from electrical chillers if heat from the CHP measure is driving an absorption chiller	Calculated	kWh/yr	
kWh_{gross}	Overall electricity generated by CHP System	Site-specific/engineering calculation	kWh/yr	
kWh_{consumed}	Annual electricity consumed by CHP system: parasitic losses due to fan and pump motors, dedicated HVAC system, and lighting	Site-specific; if unknown, assume 3% of kWh_{gross}	kWh/yr	
UHR_h	Useful heat recovered: heat that is expected to be recovered from CHP system, including any heat recovered for absorption chiller use and used on-site	Site-specific/engineering calculation	kBtu	
UHR_c	Useful heat recovered: heat that is used to drive an absorption chiller	Site-specific/engineering calculation	kBtu	
kWh_{Net}	Net electricity generation by CHP: overall electricity generated by CHP System minus annual electricity consumed by CHP system	Site-specific/engineering calculation	kWh/year	
$Fuel_{\text{Input}}$	Annual Fuel input to CHP system	Site-specific/engineering calculation	kBtu	
COP	COP of absorption chiller	Site-specific	N/A	
$Eff_{\text{ElecChiller}}$	Efficiency of baseline electric chiller	Site-specific, use 0.65 if unknown	kW/ton	[9]
12	Conversion factor	12	kBtu/ton	
Eff_{Boiler}	Efficiency of boiler that would serve heating loads in absence of CHP system	Site-specific, use 0.8 if unknown	N/A	[233]
100	Conversion factor	100	kBtu/therm	
3.412	Conversion factor	3.412	kBtu/kWh	
EUL	Effective useful life	See Measure Life	Years	

Peak Factors

Peak factors should be analyzed on a site-specific basis.

Non-Energy Impacts

CHP systems will result in emissions reduction in addition to energy savings. The amount of air emission reductions resulting from the energy savings is calculated using the energy savings at the system level and multiplying them by factors provided by the New Jersey Department of Environmental Protection, Office of Air and Energy Advisor, on May 25, 2018, Using Weighted Average of 2017 PJM On-Peak and Off-Peak annual data [10]:

Table 3-373 Electric Emission Factors

Emissions Product	Emission Reduction
CO2	1,374 lbs/MWh
NOX	1.11 lbs/MWh
SO2	0.98 lbs/MWh
Hg	1.1 mg/MWh

Table 3-374 Natural Gas Emission Factors

Emissions Product	Emission Reduction
CO2	11.7 lbs/MWh
NOX	0.0092 lbs/MWh

Measure Life

The effective useful life (EUL) is 10 years [7].¹⁴⁹

References

- [7] Simons, George, Stephan Barsun, and Charles Kurnik. 2017. Chapter 23: Combined Heat and Power, The Uniform Methods Project: Methods for Determining Energy- Efficiency Savings for Specific Measures. Golden, CO; National Renewable Energy Laboratory. NREL/SR-7A40-68579. <https://www.nrel.gov/docs/fy17osti/68579.pdf>
- [8] ASHRAE Standard 90.1-2019, Energy Standard for Buildings Except Low-Rise Residential Buildings. (ASHRAE, 2019), Table 6.8.1-6, <https://www.ashrae.org/technical-resources/standards-and-guidelines/read-only-versions-of-ashrae-standards>

¹⁴⁹ Please note that the UMP estimates a range of 10-25 years for typical CHP lifetime. This measure presents the conservative estimate of 10 years. Note that CHP measure lifetime is dependant on facility operations, fuel, and maintenance; there may be scenarios where a site-specific lifetime estimate is most appropriate.

- [9] ASHRAE Standard 90.1-2019, Energy Standard for Buildings Except Low-Rise Residential Buildings. (ASHRAE, 2019), Table 6.8.1-3, <https://www.ashrae.org/technical-resources/standards-and-guidelines/read-only-versions-of-ashrae-standards>
- [10] 2013-2017 CO₂, SO₂ and NO_x Emission Rates, (March 15, 2018) <https://www.pjm.com/-/media/library/reports-notices/special-reports/20180315-2017-emissions-report.ashx>

3.13.2 NEW CONSTRUCTION

Market	Commercial
Baseline Condition	NC
Baseline	Code
End Use Category	Whole Building
Measure Last Reviewed	January 2023

Description

This measure addresses high performance commercial and industrial new building design and construction. High performance new construction projects must either perform whole building modeling per ASHRAE guidelines or follow requirements through nationally recognized programs, including US Green Building Council's Leadership in Energy and Environmental Design (LEED) V4.1 [11], Passive House Institute US [12][297] or Passive House [13]. Minimum energy performance requirements for all new construction projects are measured from IECC 2018/2021 or ASHRAE 90.1-2016/2019 energy code or industry standard practice baselines [16]. Therefore, all projects shall result in energy performance better than that required by the applicable ASHRAE code or standard practice, i.e., the applicable New Jersey energy codes or standard practice baselines approved at the time of permit.

High performance new construction projects in NJ may target varying levels of energy performance, from a bundled measure approach per ASHRAE 90.1-2019 Addendum AP [14] to simple DOE-2 based modeling (e.g., Slipstream's Sketchbox) to comprehensive modeling per ASHRAE 90.1-2016/2019 Appendix G [15]. Simulation software used for new construction projects must comply with ASHRAE Standard 140-2020 [17].

References

- [11] LEED requirements
- [12] Passive House Institute US requirements.
- [13] Passive House Institute requirements
- [14] ASHRAE Addendum AP
- [15] ASHRAE 90.1-2016/2019 Appendix G
- [16] Commercial New Construction Industry Standard Practice Analysis
- [17] ASHRAE Standard 140-2020 Method Of Test For Evaluating Building Performance Simulation Software

3.13.3 OPERATOR TRAINING

Market	Commercial
--------	------------

Baseline Condition	RF
Baseline	Existing
End Use Subcategory	Behavior
Measure Last Reviewed	January 2023

Description

Building Operator Certification (BOC) is a training and certification program for commercial and public sector building operators. The training program teaches participants how to improve building comfort and efficiency by optimizing the building's systems. BOC provide participants with knowledge about system operations, proper maintenance practices, occupant communication, and occupant comfort. Participants realize energy savings by utilizing the knowledge gained to improve their building operations through O&M and capital measures.

Deemed savings for this measure represent a convergence of analyses results from multiple BOC program evaluations that estimated net savings and were developed per square foot of building area to account for building size diversity. All savings algorithms presented in this work paper are for net savings. Participants must complete a rigorous BOC course and can only claim savings for the facilities for which the individual taking the course is responsible.

Measure Requirements

Participants must complete either the BOC Level I or Level II course and obtain a certificate of completion to be eligible for savings. Eligible BOC must cover the following subject areas:

BOC Level 1:

- Efficient Operation of HVAC Systems
- Measuring and Benchmarking Energy
- Efficient Lighting Fundamentals
- HVAC Controls Fundamentals
- Indoor Environmental Quality
- Common Opportunities for Low-Cost Operational Improvement

BOC Level 2:

- Building Scoping and Operational Improvements
- Optimizing HVAC Controls for Energy Efficiency
- Introduction to Building Commissioning
- Water Efficiency for Building Operators
- Project Peer Exchange

The BOC course must include formal instruction (i.e., lectures), individual projects, and group exercises, bringing the total course time to at least 61 hours. Participants must obtain a training certificate of completion to be eligible for savings. Individuals who participate are not eligible for savings more than twice over the measure life, once for BOC Level I and another for BOC Level II. The entire floor area for any given building can only be used once over the measure life, and evaluators will verify attendees' participation year-over-year.

The savings factors for this measure were developed based on an examination of savings using a weighted average approach from several similar BOC programs. It is important to note that the savings information referenced is net. Therefore, this measure does not require the additional application of a net-to-gross ratio.

Note: In the event there are multiple participants who operate the same building (i.e. service address), or group of buildings, care should be taken to ensure that savings are not claimed for based on the same square footage for multiple participants.

Annual Energy Savings Algorithms

Annual Electric Energy Savings

$$\Delta kWh = C_e \times Area$$

Annual Fuel Savings

$$\Delta Therms = C_g \times Area$$

Peak Demand Savings

$$\Delta kW_{Peak} = C_d \times Area / 1000 \times CF$$

Daily Peak Fuel Savings

$$\Delta Therms_{Peak} = \Delta Therms \times PDF$$

Lifetime Energy Savings Algorithms

Lifetime Electric Energy Savings

$$\Delta kWh_{Life} = \Delta kWh \times EUL$$

Lifetime Fuel Savings

$$\Delta Therms_{Life} = \Delta Therms \times EUL$$

Calculation Parameters

Table 3-375 Calculation Parameters

Variable	Description	Value	Units	Ref
ΔkWh	Annual electric energy savings	Calculated	kWh/yr	
$\Delta Therms$	Annual fuel savings	Calculated	Therms/yr	
ΔkW_{Peak}	Peak Demand Savings	Calculated	kW	
$\Delta Therms_{Peak}$	Daily peak fuel savings	Calculated	Therms/day	
ΔkWh_{Life}	Lifetime electric energy savings	Calculated	kWh	
$\Delta Therms_{Life}$	Lifetime fuel savings	Calculated	Therms	
C_e	Unit area kWh savings constant per participant	0.482	kWh/ft ² /participant	[18]
Area	Building area operated by the participant	Site-specific	ft ²	
C_g	Unit gas savings constant per participant	0.0145	Therms/ft ² /participant	[19]
C_d	Unit demand savings constant per participant	0.039	W/ft ² /participant	[19]
1,000	Conversion factor	1,000	W/kW	
CF	Electric coincidence factor	Look up in Table 3-376	N/A	
PDF	Gas peak day factor	Look up in Table 3-376	N/A	
EUL	Effective useful life	See Measure Life Section	Years	

Peak Factors

Table 3-376 Peak Factors

Peak Factor	Value	Ref
Electric coincidence factor (CF)	1	
Natural gas peak day factor (PDF)	N/A	

Measure Life

The effective useful life (EUL) is 9.2 years [20].

References

[18] Building Operator Certification, BOC Energy Savings Summary and FAQ available at [2020-BOC-Energy-Savings-FAQ_1.0.pdf \(theboc.info\)](#)

[19] 2022 Illinois Statewide Technical Reference Manual for Energy Efficiency Version 10.0, Page 805

[20] The overall weighted average useful life for BOC savings are 1) Average measure life of capital measures from the ComEd CY2020 evaluation. 2) Useful Life for Custom Measure, Illinois TRM v10 for CY2022.

3.13.4 CUSTOM

Market	Commercial
Baseline Condition	TOS/NC/RF/EREP/ERET/DI
Baseline	Code/ISP/Existing/Dual
End Use Subcategory	Custom
Measure Last Reviewed	January 2023

Description

In addition to the typical measures for which savings algorithms have been developed, it is important to identify and address additional opportunities for energy savings. Custom measures can often provide significant energy savings and can be tailored to the specific needs of a building or facility. If necessary, the utilities may develop specific guidelines for frequent custom measures for use in reporting and contractor tracking. This will ensure that the custom measures are implemented correctly and consistently; and that the energy savings are accurately reported. Additionally, it is important to continuously monitor and evaluate the effectiveness of the custom measures implemented and make adjustments as needed.

To implement custom measures, it is necessary to develop individual calculations for each measure to determine the energy savings. These calculations should take into account factors such as the cost of implementation, the expected energy savings, and any potential changes in operations or maintenance. Once the calculations are complete, the project must be reviewed for reasonableness by either a third-party consulting engineer or a qualified in-house engineer. Before a full review of the project is started, the project package should first be checked for completeness and compliance with program eligibility rules. Once the project review is complete, savings can be reported based on these individual calculations.

Baseline

The project baseline depends on the baseline condition. For time of sale (TOS) and new construction (NC) measures, the baseline is the applicable equipment energy code or standard; or industry standard practice (ISP). For retrofit (RF), early replacement (EREP), early retirement (ER) and direct install (DI) measures, the baseline is the existing equipment. Early replacement and direct install projects replacing functioning equipment must use a dual baseline approach, where the existing equipment defines the first baseline and code or ISP defines the second baseline. In all cases, the baseline should be more efficient than the existing equipment; if the efficiency of the existing equipment exceeds code or ISP, the existing equipment baseline should also be used for the second baseline calculations. When existing functioning equipment is replaced and savings are based on early replacement, documentation of the existing equipment viability should be provided. Such documentation includes a customer affidavit affirming the viability of the equipment to function over its remaining useful life and a video or picture demonstrating the equipment in action. Trend logs, maintenance and repair records, and other evidence of existing equipment viability should be provided for larger projects.

Industry Standard Practice (ISP) shall take precedence over a code baseline when ISP can be established. Projects not subject to codes or standards shall define and document an ISP baseline as part of the project development package. ISP for specific custom projects can be established through interviews with equipment vendors or subject matter experts; or by examining similar equipment installation by customer in other facilities.

Efficient Case

The efficiency of the measure shall exceed the first (and if applicable the second) baseline efficiency, and a rationale for how the project saves energy shall be provided.

Energy Savings Algorithm

Energy and demand savings are calculated on a custom basis for each customer's specific situation. Savings are calculated as the difference between baseline energy usage/peak demand and the energy use/peak demand after implementation of the custom measure. Energy savings estimates should be calibrated against billing or metered data where possible to validate the model and test the reasonableness of energy savings. A project narrative description including system design diagrams should be provided to assist in the project review. Energy savings calculations vary according to the custom project requirements, but generally fall into the following classifications:¹⁵⁰

Simple Engineering Equations

Custom engineering calculations may be developed to estimate energy savings. These may be presented as a series of simple engineering equations tailored to the custom project measure and process. The engineering calculations must be documented and spreadsheets used to calculate the savings must be provided with live calculations. The engineering analysis must be sufficiently documented to allow an independent calculation of the measure savings.

Bin Methods

One method for calculating energy savings for custom energy efficiency measures is through the use of weather based bin analysis. This method involves analyzing weather data and grouping it into "bins" based on temperature, humidity, and other environmental factors. The bin analysis presents the number hours a particular weather condition exists during the year. Note, bin data do not consider time of day; hours tabulated for each weather bin are disconnected in time. Bin analysis is generally not applicable to time dependent measures.

Simulation

Another method for calculating energy savings for custom energy efficiency measures is through the use of whole building modeling simulations. This approach involves creating a computer model of a building that takes into account factors such as the building's layout, construction materials, HVAC systems, lighting, and other equipment. The model is then used to simulate different scenarios and analyze the building's energy consumption under different conditions. This can be useful for identifying opportunities for energy savings and for evaluating the potential impact of different custom measures. For example, a whole building simulation can be used to analyze the impact of different lighting systems, insulation materials,

¹⁵⁰ See the California Evaluation Framework [1] Chapters 6 and 7 for more information about engineering methods.

or window treatments on energy consumption. The simulation can also be used to analyze the impact of changes in occupancy, equipment usage, or other factors. Whole building modeling simulations can be a powerful tool for identifying and addressing opportunities for energy savings across a package of measures where significant measure interactions are expected.

Pre/Post Billing Analysis

Energy savings may be calculated through an analysis of whole building or submetered energy consumption before and after measure installation. The billing analysis should use a linear or multi-variate regression approach that normalizes the savings for differences in weather conditions, production and so on during the pre and post periods and also corrects for other non-routine conditions. The pre/post billing analysis should follow the International Measurement and Verification Protocol (IPMVP) Option C and/or ASHRAE Guideline 14.

Calculation Parameters

Energy savings calculations must identify the source of each parameter used in the analysis. Parameters that are uncertain should be identified as candidates for project specific measurement and verification (M&V).

Measurement and Verification

Projects where the input assumptions and savings estimates are uncertain may benefit from site specific measurement and verification (M&V). Project developers and reviewers should consider whether the project should include M&V as part of the project development process. For projects that include M&V, a site specific measurement and verification plan should be developed that documents measurement activities and their use in the energy savings analysis. Depending on the level of uncertainty, M&V may be conducted before measure installation (pre installation M&V) and/or after measure installation (post installation M&V). The International Measurement and Verification Protocol (IPMVP) and/or ASHRAE Guideline 14 should be referenced when developing an M&V plan. The M&V plans may follow IPMVP Option A (partially measured retrofit isolation), Option B (fully measure retrofit isolation) Option C (Whole building billing analysis) or Option D (Calibrated simulation) approaches.

Lifetime Energy Savings Algorithms

Lifetime energy savings for time of Sale (TOS) and new construction (NC) projects are calculated as the product of the first year kWh and/or therm savings and the measure effective useful life (EUL). Projects with multiple measures having different EULs shall use a savings weighted average EUL across all measures in the project.

Lifetime savings for early replacement (EREP), early retirement (ERET) and direct installation (DI) measures where functioning equipment is replaced must use a dual baseline approach. The first baseline savings considers the difference between the existing equipment consumption and the measure consumption for the remaining life (RUL) of the existing equipment. The second baseline savings considers the difference between code or standard practice equipment consumption and the measure consumption for the remaining life of the measure (EUL-RUL).

Peak Factors

The summer coincident peak demand savings shall be calculated consistent with the system peak definition presented in Chapter 1.

Measure Life

Measure life will be specific to each custom measure. For custom measures using technologies that are the same or similar to those addressed in other TRM measures, refer to those measures for measure lives. For measures not covered by the TRM, measure life assumptions shall be documented and justified in the project documentation package such as ASHRAE or manufacturer specifications. The EUL for retrofit (RF) measures shall be calculated as the smaller of the measure EUL or the host equipment remaining useful life (RUL). The overall project EUL shall be the savings weighted EUL of the measures included in the project.

References

- [21] California Evaluation Framework. Available at https://www.cpuc.ca.gov/-/media/cpuc-website/files/uploadedfiles/cpuc_public_website/content/utilities_and_industries/energy/energy_programs/demand_side_management/ee_and_energy_savings_assist/caevaluationframework.pdf
- [22] International Measurement and Verification Protocol (IPMVP) available at <https://evo-world.org/en/products-services-mainmenu-en/protocols/ipmvp>
- [23] ASHRAE Guideline 14-2014. Available at <https://webstore.ansi.org/standards/ashrae/ashraeguideline142014>

4 APPENDIX A: CLIMATE ZONE DESCRIPTIONS

Weather-dependent parameters are presented by climate zone throughout the TRM when applicable. The Office of the State Climatologist divides the state into five climate regions as shown below.¹⁵¹

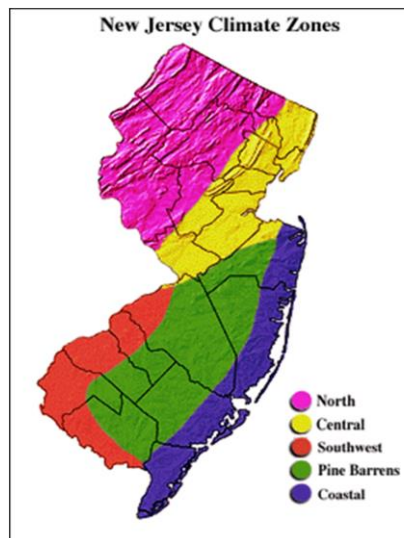

A representative city from the TMY3 long term average weather data set was assigned to each of the climate zones.¹⁵² A population weight derived from 2020 Census data was assigned to each of the climate zones to compute a statewide average value as shown below.¹⁵³

Table 4-1 Climate Zone Representative Cities and Weights

NJ Climate Division	Representative City	Population Weight
Northern Zone	Allentown, PA	0.17
Central Zone	Trenton, NJ	0.45
Pine Barrens Zone	McGuire Air Force Base, NJ	0.11
Southwest Zone	Philadelphia, PA	0.11
Coastal Zone	Atlantic City, NJ	0.16

Please note all utilities should use weighted average value for EFLH, as presented in Appendix C: . For other climate parameters, utilities may differentiate by climate zone or may default to the statewide average value.

¹⁵¹ <https://climate.rutgers.edu/stateclim/>

¹⁵² <https://www.nrel.gov/docs/fy08osti/43156.pdf>

¹⁵³ <https://www.census.gov/library/stories/state-by-state/new-jersey-population-change-between-census-decade.html>

5 APPENDIX B: BUILDING PROTOTYPE DESCRIPTIONS

Analysis used to develop heating and cooling equivalent full load hours is based on DOE-2.2 simulations of a set of prototypical small and large buildings. The prototypical simulation models were derived from the commercial building prototypes used in the California Database for Energy Efficiency Resources (DEER) study, with adjustments made for local building practices and climate.¹⁵⁴ The simulations were driven using Typical Meteorological Year (TMY3) long-term average weather data.¹⁵⁵

¹⁵⁴ 2004-2005 Database for Energy Efficiency Resources (DEER) Update Study, Final Report, Itron, Inc. Vancouver, WA. December 2005. Available at www.calmac.org/publications/2004-05_DEER_Update_Final_Report-Wo.pdf.

¹⁵⁵ See: Wilcox and Marion, "Users Manual for TMY3 Data Sets," NREL/TP-581-43156, National Renewable Energy Lab, May 2008. <https://www.nrel.gov/docs/fy08osti/43156.pdf>

5.1 ASSEMBLY

A prototypical building energy simulation model for an assembly building was developed using the DOE-2.2 building energy simulation program. The simulations were driven using TMY3 long-term average weather data. The characteristics of the prototype are summarized below.

ASSEMBLY PROTOTYPE BUILDING DESCRIPTION

Characteristic	Value
Vintage	Existing (1970s) vintage
Size	34,000 square feet Auditorium: 33,240 SF Office: 760 SF
Number of floors	1
Wall construction and R-value	Concrete block, R-5
Roof construction and R-value	Wood frame with built-up roof, R-12
Glazing type	Single pane clear
Lighting power density	Auditorium: 3.4 W/SF Office: 2.2 W/SF
Plug load density	Auditorium: 1.2 W/SF Office: 1.7 W/SF
Operating hours	Mon-Sun: 8am – 9pm
HVAC system type	Packaged single zone, no economizer
HVAC system size	100 - 110 SF/ton depending on climate
Thermostat set points	Occupied hours: 76 °F cooling, 72 °F heating Unoccupied hours: 79 °F cooling, 69 °F heating

A computer-generated sketch of the Assembly Building prototype is shown below.

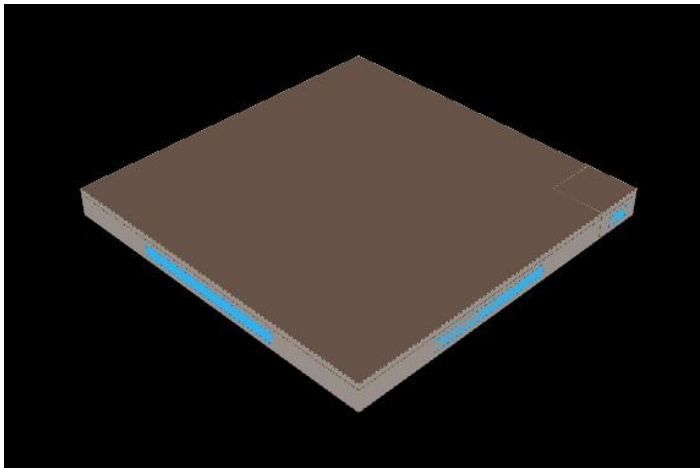

5.2 AUTO REPAIR

A prototypical building energy simulation model for an auto repair building was developed using the DOE-2.2 building energy simulation program. The simulations were driven using TMY3 long-term average weather data. The characteristics of the prototype are summarized below.

AUTO REPAIR PROTOTYPE BUILDING DESCRIPTION

Characteristic	Value
Vintage	Existing (1970s) vintage
Size	5150 square feet
Number of floors	1
Wall construction and R-value	Concrete block, R-7.5
Roof construction and R-value	Wood frame with built-up roof, R-13.5
Glazing type	Double pane clear; SHGC = .74, U-value = 0.72
Lighting power density	2.2 W/SF
Plug load density	1.2 W/SF
Operating hours	Mon-Sun: 9am – 9pm
HVAC system type	Packaged single zone, no economizer
HVAC system size	280 SF/ton
Thermostat set points	Occupied hours: 76 °F cooling, 72 °F heating Unoccupied hours: 81 °F cooling, 67 °F heating

A computer-generated sketch of the Auto Repair Building prototype is shown below.

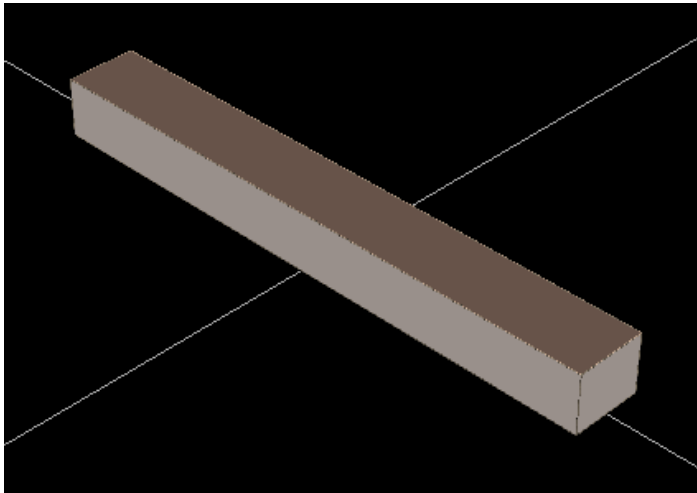

5.3 BIG BOX RETAIL

A prototypical building energy simulation model for a big box retail building was developed using the DOE-2.2 building energy simulation program. The simulations were driven using TMY3 long-term average weather data. The characteristics of the prototype are summarized below.

BIG BOX RETAIL PROTOTYPE BUILDING DESCRIPTION

Characteristic	Value
Vintage	Existing (1970s) vintage
Size	130,500 square feet Sales: 107,339 SF Storage: 11,870 SF Office: 4,683 SF Auto repair: 5,151 SF Kitchen: 1,459 SF
Number of floors	1
Wall construction and R-value	Concrete block with insulation, R-5
Roof construction and R-value	Metal frame with built-up roof, R-12
Glazing type	Single pane clear
Lighting power density	Sales: 3.36 W/SF Storage: 0.88 W/SF Office: 2.2 W/SF Auto repair: 2.15 W/SF Kitchen: 4.3 W/SF
Plug load density	Sales: 1.15 W/SF Storage: 0.23 W/SF Office: 1.73 W/SF Auto repair: 1.15 W/SF Kitchen: 3.23 W/SF
Operating hours	Mon-Sun: 10am – 9pm
HVAC system type	Packaged single zone, no economizer
HVAC system size	230 - 260 SF/ton depending on climate
Thermostat set points	Occupied hours: 76 °F cooling, 72 °F heating Unoccupied hours: 79 °F cooling, 69 °F heating

A computer-generated sketch of the Big Box Building prototype is shown below.

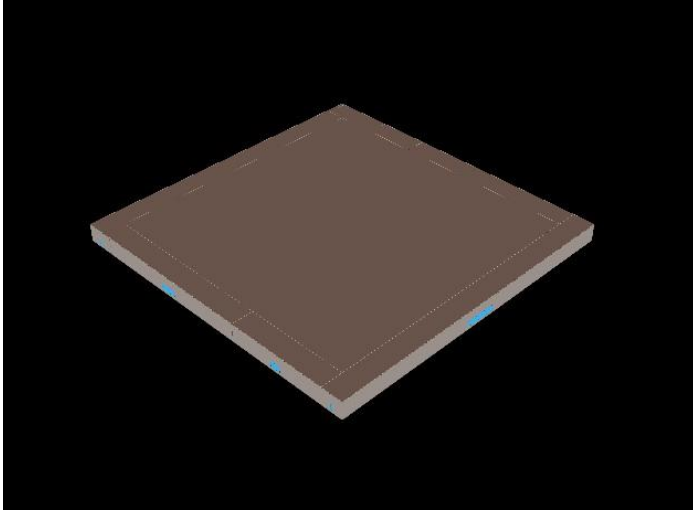

5.4 COMMUNITY COLLEGE

A prototypical building energy simulation model for a community college was developed using the DOE-2.2 building energy simulation program. The simulations were driven using TMY3 long-term average weather data. The model is really two identical buildings oriented 90 degrees apart. The characteristics of the prototype are summarized below.

Community College Prototype Building Description

Characteristic	Value
Vintage	Existing (1970s) vintage
Size	2 buildings, 150,000 square feet each; oriented 90° from each other Classroom: 150,825 SF Computer room: 9,625 SF Dining area: 26,250 SF Kitchen: 5,625 SF Office: 70,175 SF Total: 300,000 SF
Number of floors	3
Wall construction and R-value	CMU with brick veneer, plus R-7.5
Roof construction and R-value	Wood frame with built-up roof, R-13.5
Glazing type	Double pane clear, SHGC = 0.73; U-value = 0,72
Lighting power density	Classroom: 3.6 W/SF Computer room: 3.6 W/SF Dining area: 1.5 W/SF Gymnasium: 1.8 W/SF Kitchen: 3.6 W/SF
Plug load density	Classroom: 1.1 W/SF Computer room: 5.5 W/SF Dining area: 0.6 W/SF Gymnasium: 0.6 W/SF Kitchen: 3.3 W/SF
Operating hours	Mon-Fri: 8am – 7pm Sat: 8am – 4pm Sun: closed
HVAC system type	Combination PSZ and built-up with screw chiller and hot water boiler.
HVAC system size	250 SF/ton
Thermostat set points	Occupied hours: 76 cooling, 72 heating Unoccupied hours: 81 cooling, 67 heating
Chiller type	Water cooled and air cooled
Chilled water system type	Variable volume with 2 way control valves
Chilled water system control	Constant CHW Temp, 45 °F set point
Boiler type	Hot water, 80% efficiency
Hot water system type	Variable volume with 2 way control valves,
Hot water system control	Constant HW Temp, 180 °F set point

Each set of measures was run using each of three different HVAC system configurations: a constant volume reheat system without economizer, a constant volume reheat system with economizer, and a VAV system with economizer. The constant volume reheat system without economizer represents a system with the most heating and cooling operating hours, while the VAV system with economizer represents a system with the least heating and cooling hours. This presents a range of system loads and energy savings.

A computer-generated sketch of the Community College Building prototype is shown below.

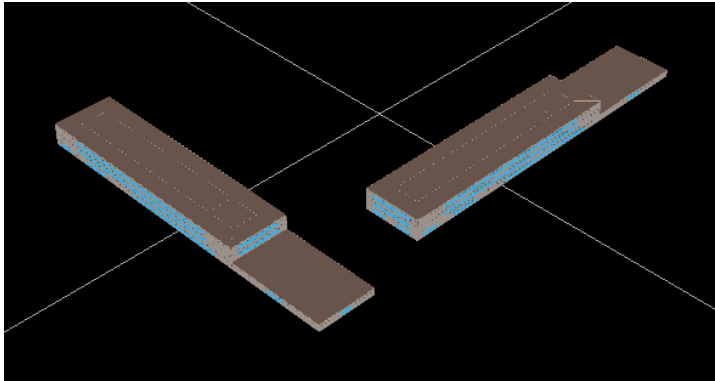

5.5 DORMITORY

A prototypical building energy simulation model for a university dormitory was developed using the DOE-2.2 building energy simulation program. The dormitory building was extracted from the DEER university prototype and modeled separately. The model consists of two identical buildings oriented 90 degrees apart. The simulations were driven using TMY3 long-term average weather data. The characteristics of the prototype are summarized below.

DORMITORY PROTOTYPE BUILDING DESCRIPTION

Characteristic	Value
Vintage	Existing (1970s) vintage
Size	170,000 square feet
Number of floors	4
Wall construction and R-value	CMU with R-7.5
Roof construction and R-value	Wood frame with built-up roof, R-13.5
Glazing type	Double pane clear; SHGC = 0.73 U-value = 0.72
Lighting power density	Rooms: 0.5 W/SF Corridors and common space: 0.8 W/SF
Plug load density	Rooms: 0.6 W/SF Corridors and common space: 0.2 W/SF
Operating hours	24/7 – 365 days
HVAC system type	Fan coils with centrifugal chiller and hot water boiler
HVAC system size	800 SF/ton
Thermostat set points	Daytime hours: 76 °F cooling, 72 °F heating Night setback hours: 81 °F cooling, 67 °F heating

A computer-generated sketch of the Dormitory Building prototype is shown below.

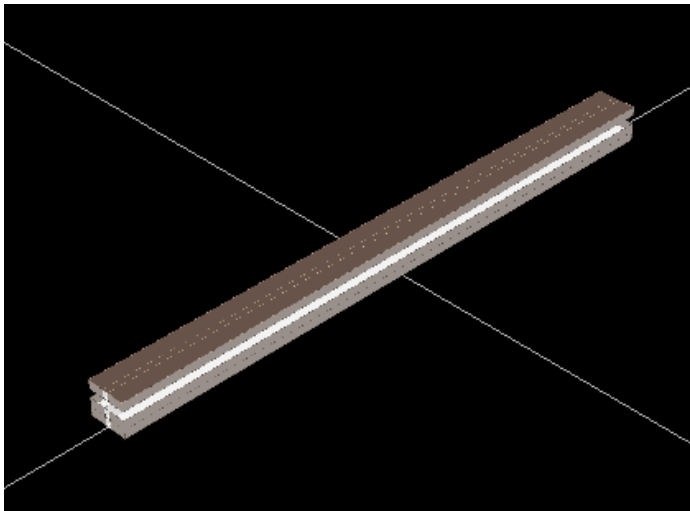

Note: The middle floors, since they thermally equivalent, are simulated as a single floor, and the results are multiplied by 2 to represent the energy consumption of the 2 middle floors.

5.6 ELEMENTARY SCHOOL

A prototypical building energy simulation model for an elementary school was developed using the DOE-2.2 building energy simulation program. The simulations were driven using TMY3 long-term average weather data. The model is really of two identical buildings oriented in two different directions. The characteristics of the prototype are summarized below.

ELEMENTARY SCHOOL PROTOTYPE BUILDING DESCRIPTION

Characteristic	Value
Vintage	Existing (1970s) vintage
Size	2 buildings, 25,000 square feet each; oriented 90° from each other Classroom: 15,750 SF Cafeteria: 3,750 SF Gymnasium: 3,750 SF Kitchen: 1,750 SF
Number of floors	1
Wall construction and R-value	Wood frame with brick veneer, R-5
Roof construction and R-value	Wood frame with built-up roof, R-12
Glazing type	Single pane clear
Lighting power density	Classroom: 4.4 W/SF Cafeteria: 1.7 W/SF Gymnasium: 2.1 W/SF Kitchen: 4.3 W/SF
Plug load density	Classroom: 1.2 W/SF Cafeteria: 0.6 W/SF Gymnasium: 0.6 W/SF Kitchen: 4.2 W/SF
Operating hours	Mon-Fri: 8am – 6pm Sun: 8am – 4pm
HVAC system type	Packaged single zone, no economizer
HVAC system size	160 - 180 SF/ton depending on climate
Thermostat set points	Occupied hours: 76 °F cooling, 72 °F heating Unoccupied hours: 79 °F cooling, 69 °F heating

A computer-generated sketch of the Elementary School Building prototype is shown below.

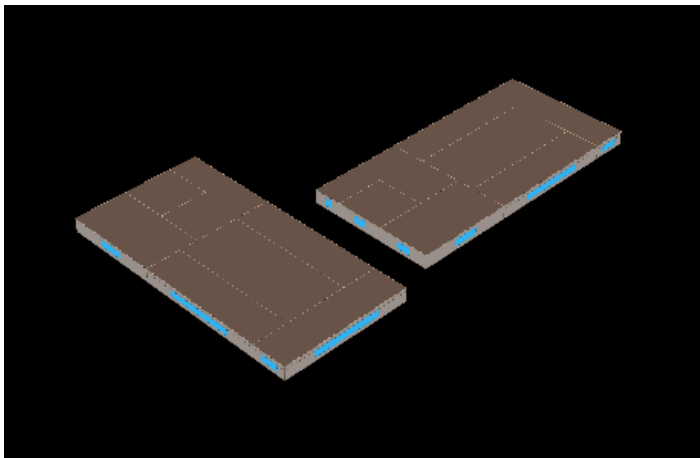

5.7 FAST FOOD RESTAURANT

A prototypical building energy simulation model for a fast food restaurant was developed using the DOE-2.2 building energy simulation program. The simulations were driven using TMY3 long-term average weather data. The characteristics of the prototype are summarized below.

FAST FOOD RESTAURANT PROTOTYPE BUILDING DESCRIPTION

Characteristic	Value
Vintage	Existing (1970s) vintage
Size	2000 square feet 1,000 SF dining 600 SF entry/lobby 300 SF kitchen 100 SF restroom
Number of floors	1
Wall construction and R-value	Concrete block with brick veneer, R-5
Roof construction and R-value	Concrete deck with built-up roof, R-12
Glazing type	Single pane clear
Lighting power density	1.7 W/SF dining 2.5 W/SF entry/lobby 4.3 W/SF kitchen 1.0 W/SF restroom
Plug load density	0.6 W/SF dining 0.6 W/SF entry/lobby 4.3 W/SF kitchen 0.2 W/SF restroom
Operating hours	Mon-Sun: 6am – 11pm
HVAC system type	Packaged single zone, no economizer
HVAC system size	100 – 120 SF/ton depending on climate
Thermostat set points	Occupied hours: 77 °F cooling, 72 °F heating Unoccupied hours: 80 °F cooling, 69 °F heating

A computer-generated sketch of the Fast Food Building prototype is shown below.

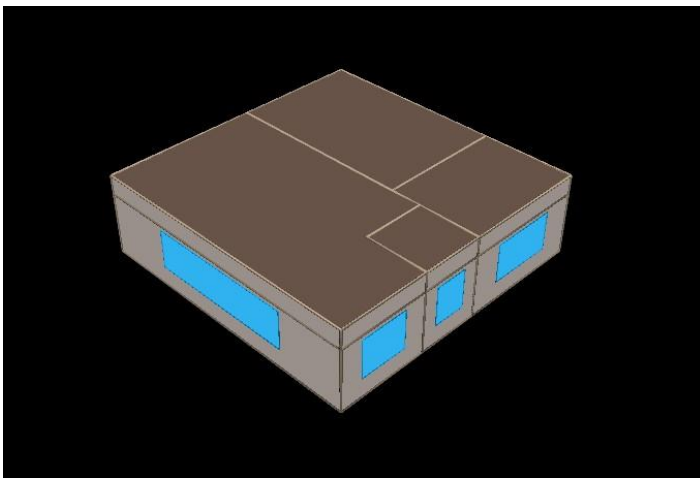

5.8 FULL-SERVICE RESTAURANT

A prototypical building energy simulation model for a full-service restaurant was developed using the DOE-2.2 building energy simulation program. The simulations were driven using TMY3 long-term average weather data. The characteristics of the full service restaurant prototype are summarized below.

FULL SERVICE RESTAURANT PROTOTYPE DESCRIPTION

Characteristic	Value
Vintage	Existing (1970s) vintage
Size	2000 square foot dining area 600 square foot entry/reception area 1200 square foot kitchen 200 square foot restrooms
Number of floors	1
Wall construction and R-value	Concrete block with brick veneer, R-5
Roof construction and R-value	Wood frame with built-up roof, R-12
Glazing type	Single pane clear
Lighting power density	Dining area: 1.7 W/SF Entry area: 2.5 W/SF Kitchen: 4.3 W/SF Restrooms: 1.0 W/SF
Plug load density	Dining area: 0.6 W/SF Entry area: 0.6 W/SF Kitchen: 3.1 W/SF Restrooms: 0.2 W/SF
Operating hours	9am – 12am
HVAC system type	Packaged single zone, no economizer
HVAC system size	140 – 160 SF/ton depending on climate
Thermostat set points	Occupied hours: 77 °F cooling, 72 °F heating Unoccupied hours: 80 °F cooling, 69 °F heating

A computer-generated sketch of the Full-Service Restaurant Building prototype is shown below.

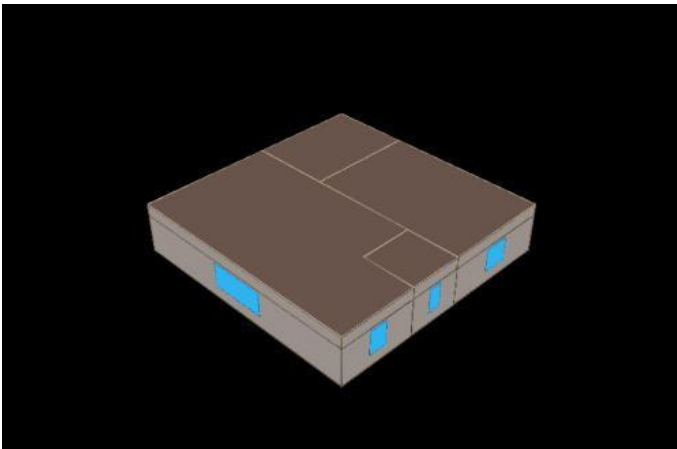

5.9 GROCERY

A prototypical building energy simulation model for a grocery building was developed using theDOE-2.2R¹⁵⁶ building energy simulation program. The simulations were driven using TMY3 long-term average weather data. The characteristics of the prototype are summarized below.

GROCERY PROTOTYPE BUILDING DESCRIPTION

Characteristic	Value
Vintage	Existing (1970s) vintage
Size	50,000 square feet Sales: 40,000 SF Office and employee lounge: 3,500 SF Dry storage: 2,860 SF 50°F prep area: 1,268 SF 35°F walk-in cooler: 1,560 SF - 5°F walk-in freezer: 812 SF
Number of floors	1
Wall construction and R-value	Concrete block with insulation, R-5
Roof construction and R-value	Metal frame with built-up roof, R-12
Glazing type	Single pane clear
Lighting power density	Sales: 3.36 W/SF Office: 2.2 W/SF Storage: 1.82 W/SF 50°F prep area: 4.3 W/SF 35°F walk-in cooler: 0.9 W/SF - 5°F walk-in freezer: 0.9 W/SF
Equipment power density	Sales: 1.15 W/SF Office: 1.73 W/SF Storage: 0.23 W/SF 50°F prep area: 0.23 W/SF + 36 kBTU/h process load 35°F walk-in cooler: 0.23 W/SF + 17 kBTU/h process load - 5°F walk-in freezer: 0.23 W/SF+ 29 kBTU/h process load
Operating hours	Mon-Sun: 6am – 10pm
HVAC system type	Packaged single zone, no economizer
Refrigeration system type	Air cooled multiplex
Refrigeration system size	Low temperature (-20°F suction temp): 23 compressor ton Medium temperature (18°F suction temp): 45 compressor ton
Refrigeration condenser size	Low temperature: 535 kBTU/h THR Medium temperature: 756 kBTU/h THR
Thermostat set points	Occupied hours: 74°F cooling, 70°F heating Unoccupied hours: 79°F cooling, 65°F heating

¹⁵⁶ DOE-2.2R is a specialized version of the DOE-2.2 program, designed specifically to model refrigeration systems.

A computer-generated sketch of the Grocery Building prototype is shown below.

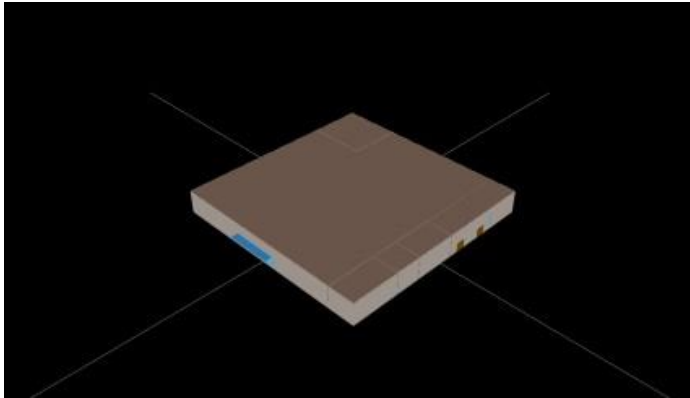

5.10 HIGH SCHOOL

A prototypical building energy simulation model for a high school was developed using the DOE-2.2 building energy simulation program. The simulations were driven using TMY3 long-term average weather data. The model is really of four identical buildings oriented in four different directions, with a common gymnasium. The characteristics of the prototype are summarized below.

HIGH SCHOOL PROTOTYPE BUILDING DESCRIPTION

Characteristic	Value
Vintage	Existing (1970s) vintage
Size	4 buildings, 25,000 square feet each; oriented 90° from each other Classroom: 88,200 SF Computer room: 3,082 SF Dining area: 22,500 SF Gymnasium: 22,500 SF Kitchen: 10,500 SF Office: 3,218 SF Total: 150,000 SF
Number of floors	2
Wall construction and R-value	CMU with brick veneer, plus R-7.5
Roof construction and R-value	Wood frame with built-up roof, R-13.5
Glazing type	Double pane clear, SHGC = 0.73; U-value = 0.72
Lighting power density	Classroom: 3.6 W/SF Computer room: 3.6 W/SF Dining area: 1.5 W/SF Gymnasium: 1.8 W/SF Kitchen: 3.6 W/SF
Plug load density	Classroom: 1.1 W/SF Computer room: 5.5 W/SF Dining area: 0.6 W/SF Gymnasium: 0.6 W/SF Kitchen: 3.3 W/SF
Operating hours	Mon-Fri: 8am – 7pm Sat: 8am – 4pm Sun: closed
HVAC system type	Combination PSZ and built-up with screw chiller and hot waterboiler.
HVAC system size	250 SF/ton
Thermostat set points	Occupied hours: 76°F cooling, 72 °F heating Unoccupied hours: 81°F cooling, 67 °F heating

A computer-generated sketch of the High School Building prototype is shown below.

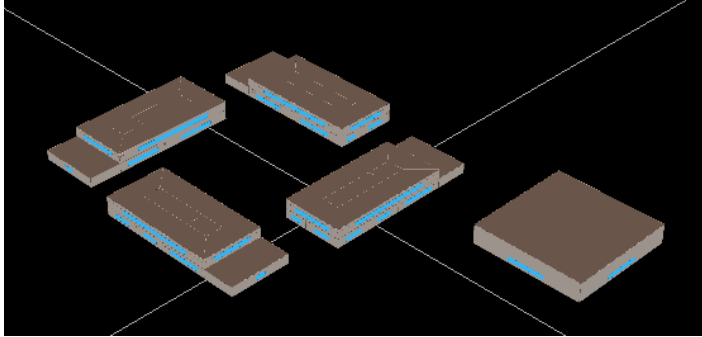

5.11 HOSPITAL

A prototypical building energy simulation model for a large hospital building was developed using the DOE-2.2 building energy simulation program. The simulations were driven using TMY3 long-term average weather data. The characteristics of the prototype are summarized below.

LARGE HOSPITAL PROTOTYPE BUILDING DESCRIPTION

Characteristic	Value
Vintage	Existing (1970s) vintage
Size	250,000 square feet
Number of floors	3
Wall construction and R-value	Brick and CMU, R=7.5
Roof construction and R-value	Built-up roof, R-13.5
Glazing type	Multi-pane; Shading-coefficient = 0.84; U-value = 0.72
Lighting power density	Patient rooms: 2.3 W/SF Office: 2.2 W/SF Lab: 4.4 W/SF Dining: 1.7 W/SF Kitchen and food prep: 4.3 W/SF
Plug load density	Patient rooms: 1.7 W/SF Office: 1.7 W/SF Lab: 1.7 W/SF Dining: 0.6 W/SF Kitchen and food prep: 4.6 W/SF
Operating hours	24/7, 365
HVAC system types	Patient Rooms: 4 pipe fan coil Kitchen: Rooftop DX Remaining space; 1. Central constant volume system with hydronic reheat, without economizer; 2. Central constant volume system with hydronic reheat, with economizer; 3. Central VAV system with hydronic reheat, with economizer
HVAC system size	Based on ASHRAE design day conditions, 10% over-sizing assumed.
Chiller type	Water cooled and air cooled
Chilled water system type	Constant volume with 3 way control valves
Chilled water system control	Constant CHW Temp, 45 °F set point
Boiler type	Hot water, 80% efficiency
Hot water system type	Constant volume with 3 way control valves
Hot water system control	Constant HW Temp, 180°F set point
Thermostat set points	Occupied hours: 76°F cooling, 72°F heating Unoccupied hours: 79°F cooling, 69°F heating

Each set of measures was run using each of three different HVAC system configurations: a constant volume reheat system without economizer, a constant volume reheat system with economizer, and a VAV system with

economizer. The constant volume reheat system without economizer represents a system with the most heating and cooling operating hours, while the VAV system with economizer represents a system with the least heating and cooling hours. This presents a range of system loads and energy savings for each measure analyzed.

A computer-generated sketch of the Large Hospital Building prototype is shown below.

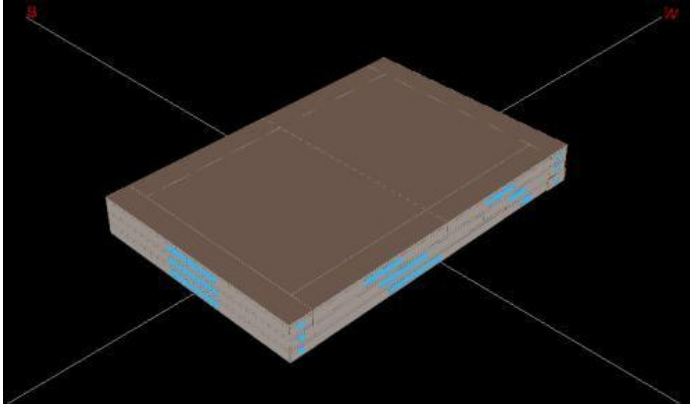

5.12 HOTEL

A prototypical building energy simulation model for a hotel building was developed using the DOE-2.2 building energy simulation program. The characteristics of the prototype are summarized below.

HOTEL PROTOTYPE BUILDING DESCRIPTION

Characteristic	Value
Vintage	Existing (1970s) vintage
Size	200,000 square feet total Bar, cocktail lounge – 800 SF Corridor – 20,100 SF Dining Area – 1,250 SF Guest rooms – 160,680 SF Kitchen – 750 SF Laundry – 4,100 SF Lobby – 8,220 SF Office – 4,100 SF
Number of floors	11
Wall construction and R-value	Block construction, R-7.5
Roof construction and R-value	Wood deck with built-up roof, R-13.5
Glazing type	Multi-pane; Shading-coefficient = 0.84 U-value = 0.72
Lighting power density	Bar, cocktail lounge – 1.7 W/SF Corridor – 1.0 W/SF Dining Area – 1.7 W/SF Guest rooms – 0.6 W/SF Kitchen – 4.3 W/SF Laundry – 1.8 W/SF Lobby – 3.1 W/SF Office – 2.2 W/SF
Plug load density	Bar, cocktail lounge – 1.2 W/SF Corridor – 0.2 W/SF Dining Area – 0.6 W/SF Guest rooms – 0.6 W/SF Kitchen – 3.0 W/SF Laundry – 3.5 W/SF Lobby – 0.6 W/SF Office – 1.7 W/SF
Operating hours	Rooms: 60% occupied, 40% unoccupied All others: 24 hr / day
HVAC system type	Central built-up system: All except corridors and rooms 1. Central constant volume system with perimeter hydronic reheat, without economizer; 2. Central constant volume system with perimeter hydronic reheat, with economizer; 3. Central VAV system with perimeter hydronic reheat, with economizer PTAC (Packaged Terminal Air Conditioner): Guest rooms PSZ: Corridors

Characteristic	Value
HVAC system sizeM	Based on ASHRAE design day conditions, 10% over-sizing assumed
Minimum outdoor air fraction	Built up system 0.3; PSZ: 0.14; PTAC: 0.11 is typical
Chiller type	Water cooled and air cooled
Chilled water system type	Constant volume with 3 way control valves
Chilled water system control	Constant CHW Temp, 45 °F set point
Boiler type	Hot water, 80% efficiency
Hot water system type	Constant volume with 3 way control valves
Hot water system control	Constant HW Temp, 180 °F set point
Thermostat set points	Occupied hours: 76 °F cooling, 72 °F heating Unoccupied hours: 81 °F cooling, 67 °F heating

A computer-generated sketch of the Hotel Building prototype is shown below.

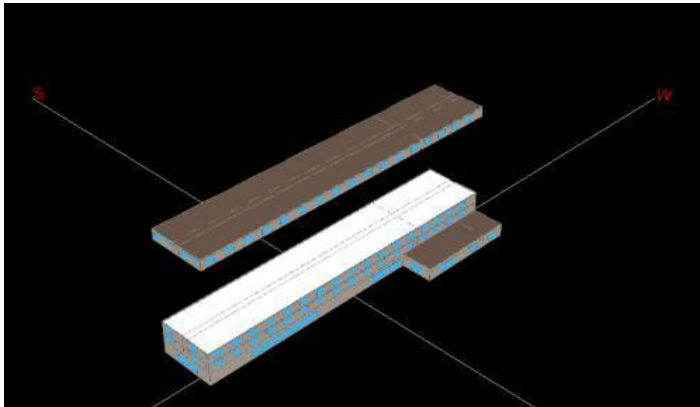

5.13 LARGE OFFICE

A prototypical building energy simulation model for a large office building was developed using the DOE-2.2 building energy simulation program. The simulations were driven using TMY3 long-term average weather data. The characteristics of the prototype are summarized below.

LARGE OFFICE PROTOTYPE BUILDING DESCRIPTION

Characteristic	Value
Vintage	Existing (1970s) vintage
Size	350,000 square feet
Number of floors	10
Wall construction and R-value	Glass curtain wall, R-7.5
Roof construction and R-value	Built-up roof, R-13.5
Glazing type	Multi-pane; Shading-coefficient = 0.84; U-value = 0.72
Lighting power density	Perimeter offices: 1.55 W/SF Core offices: 1.45 W/SF
Plug load density	Perimeter offices: 1.6 W/SF Core offices: 0.7 W/SF
Operating hours	Mon-Sat: 9am – 6pm Sun: Unoccupied
HVAC system types	1. Central constant volume system with hydronic reheat, without economizer; 2. Central constant volume system with hydronic reheat, with economizer; 3. Central VAV system with hydronic reheat, with economizer
HVAC system size	Based on ASHRAE design day conditions, 10% over-sizing assumed
Chiller type	Water cooled and air cooled
Chilled water system type	Constant volume with 3 way control valves
Chilled water system control	Constant CHW Temp, 45 °F set point
Boiler type	Hot water, 80% efficiency
Hot water system type	Constant volume with 3 way control valves
Hot water system control	Constant HW Temp, 180 °F set point
Thermostat set points	Occupied hours: 75 °F cooling, 70 °F heating Unoccupied hours: 78 °F cooling, 67 °F heating

Each set of measures was run using each of three different HVAC system configurations: a constant volume reheat system without economizer, a constant volume reheat system with economizer, and a VAV system with economizer. The constant volume reheat system without economizer represents a system with the most heating and cooling operating hours, while the VAV system with economizer represents a system with the least heating and cooling hours. This presents a range of system loads and energy savings for each measure analyzed.

A computer-generated sketch of the Large Office Building prototype is shown below.

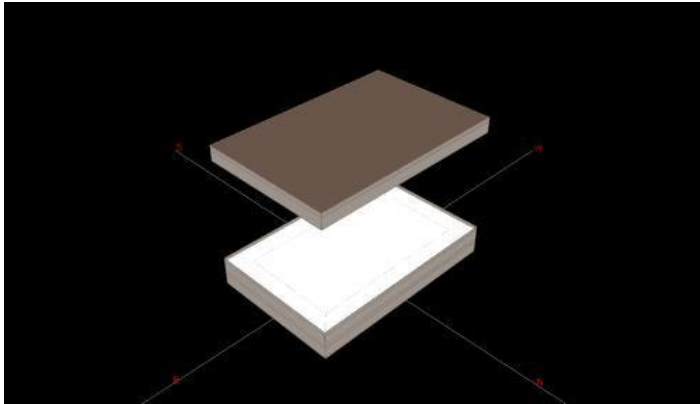

Note: The middle floors, since they thermally equivalent, are simulated as a single floor, and the results are multiplied by 8 to represent the energy consumption of the eight middle floors.

5.14 LARGE RETAIL

A prototypical building energy simulation model for a large retail building was developed using the DOE-2.2 building energy simulation program. The simulations were driven using TMY3 long-term average weather data. The characteristics of the prototype are summarized below.

LARGE RETAIL PROTOTYPE BUILDING DESCRIPTION

Characteristic	Value
Vintage	Existing (1970s) vintage
Size	130,000 square feet Sales area: 96,000 SF Storage: 18,000 SF Office: 6,000 SF
Number of floors	3
Wall construction and R-value	Brick and CMU with R-7.5
Roof construction and R-value	Built-up roof, R-13.5
Glazing type	Multi-pane; SHGC= 0.73; U-value = 0.72
Lighting power density	Sales area: 2.8 W/SF Storage: 0.8 W/SF Office: 1.8 W/SF
Plug load density	Sales area: 1.1 W/SF Storage: 0.2 W/SF Office: 1.7 W/SF
Operating hours	Mon-Sat: 9am – 10pm Sun: 9am – 7pm
HVAC system types	1. Central constant volume system with hydronic reheat, without economizer; 2. Central constant volume system with hydronic reheat, with economizer; 3. Central VAV system with hydronic reheat, with economizer
HVAC system size	340 SF/ton
Chiller type	Water cooled and air cooled
Chilled water system type	Variable volume with 2 way control valves
Chilled water system control	Constant CHW Temp, 45 °F set point
Boiler type	Hot water, 80% efficiency
Hot water system type	Variable volume with 2 way control valves
Hot water system control	Constant HW Temp, 180 °F set point
Thermostat set points	Occupied hours: 76 °F cooling, 72 °F heating Unoccupied hours: 81 °F cooling, 67 °F heating

Each set of measures was run using each of three different HVAC system configurations: a constant volume reheat system without economizer, a constant volume reheat system with economizer, and a VAV system with economizer. The constant volume reheat system without economizer represents a system with the most heating and cooling operating hours, while the VAV system with economizer represents a system with the least heating and cooling hours. This presents a range of system loads and energy savings for each measure analyzed.

A computer-generated sketch of the Large Retail Building prototype is shown below.

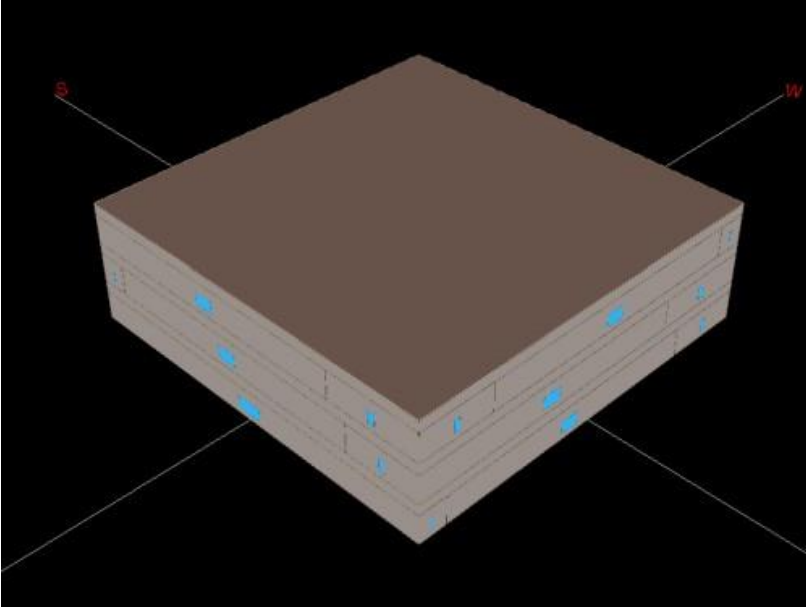

5.15 LIGHT INDUSTRIAL

A prototypical building energy simulation model for a light industrial building was developed using the DOE-2.2 building energy simulation program. The simulations were driven using TMY3 long-term average weather data. The characteristics of the prototype are summarized below.

LIGHT INDUSTRIAL PROTOTYPE BUILDING DESCRIPTION

Characteristic	Value
Vintage	Existing (1970s) vintage
Size	100,000 square feet total 80,000 SF factory 20,000 SF warehouse
Number of floors	1
Wall construction and R-value	Concrete block with insulation, R-5
Roof construction and R-value	Concrete deck with built-up roof, R-12
Glazing type	Single pane clear
Lighting power density	Factory – 2.1 W/SF Warehouse – 0.9 W/SF
Plug load density	Factory – 1.2 W/SF Warehouse – 0.2 W/SF
Operating hours	Mon-Fri: 6am – 6pm Sat Sun: Unoccupied
HVAC system type	Packaged single zone, no economizer
HVAC system size	500 - 560 SF/ton depending on climate
Thermostat set points	Occupied hours: 78 cooling, 70 heating Unoccupied hours: 81 cooling, 67 heating

A computer-generated sketch of the Light Industrial Building prototype is shown below.

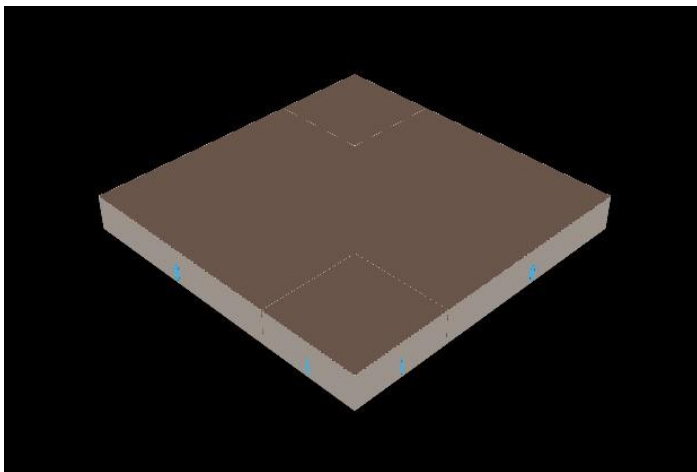

5.16 MOTEL

A prototypical building energy simulation model for a motel was developed using the DOE-2.2 building energy simulation program. The simulations were driven using TMY3 long-term average weather data. The characteristics of the prototype are summarized below.

MOTEL PROTOTYPE BUILDING DESCRIPTION

Characteristic	Value
Vintage	Existing (1970s) vintage
Size	30,000 square feet
Number of floors	2
Wall construction and R-value	Frame with R-5
Roof construction and R-value	Wood frame with built-up roof, R-12
Glazing type	Single pane clear; SHGC = .87 U-value = 1.2
Lighting power density	0.6 W/SF
Plug load density	0.6 W/SF
Operating hours	24/7 - 365
HVAC system type	PTAC with electric heat
HVAC system size	540 SF/ton
Thermostat set points	Daytime hours: 76°F cooling, 72°F heating Night setback hours: 81 °F cooling, 67 °F heating

A computer-generated sketch of the Motel Building prototype is shown below.

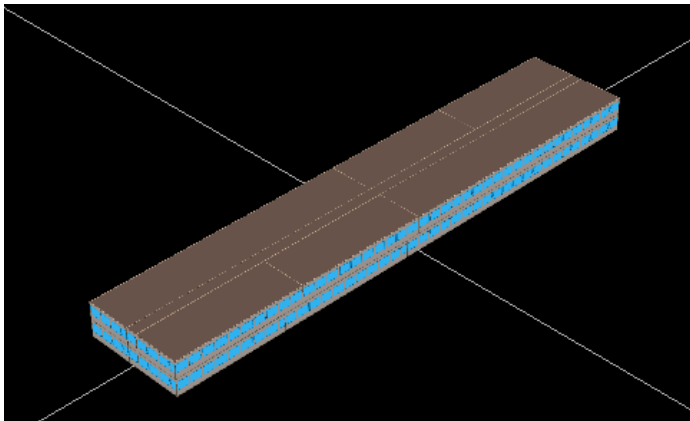

5.17 RELIGIOUS

A prototypical building energy simulation model for a religious worship building was developed using the DOE-2.2 building energy simulation program. The simulations were driven using TMY3 long-term average weather data. The characteristics of the prototype are summarized below.

RELIGIOUS WORSHIP PROTOTYPE BUILDING DESCRIPTION

Characteristic	Value
Vintage	Existing (1970s) vintage
Size	11,000 square feet
Number of floors	1
Wall construction and R-value	Brick with R-5
Roof construction and R-value	Wood frame with built-up roof, R-12
Glazing type	Single pane clear; SHGC = .87, U-value = 1.2
Lighting power density	1.7 W/SF
Plug load density	1.2 W/SF
Operating hours	Mon-Sat: 12pm-6pm Sun: 9am-7pm
HVAC system type	Packaged single zone, no economizer
HVAC system size	250 SF/ton
Thermostat set points	Occupied hours: 76°F cooling, 70°F heating Unoccupied hours: 82°F cooling, 64°F heating

A computer-generated sketch of the Religious Building prototype is shown below.

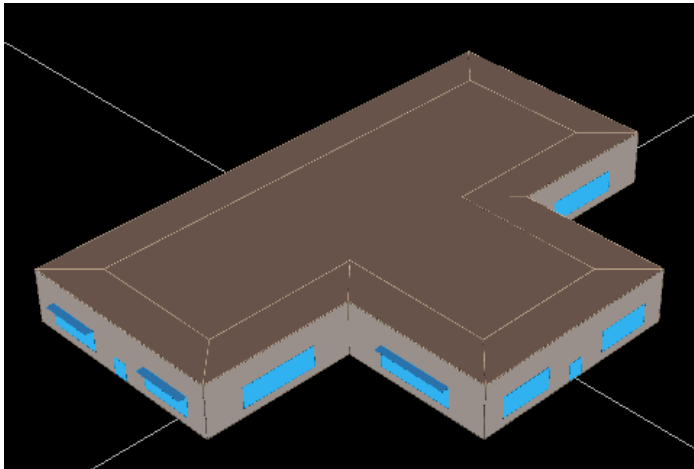

5.18 SMALL OFFICE

A prototypical building energy simulation model for a small office was developed using the DOE-2.2 building energy simulation program. The simulations were driven using TMY3 long-term average weather data. The characteristics of the small office prototype are summarized below.

SMALL OFFICE PROTOTYPE BUILDING DESCRIPTION

Characteristic	Value
Vintage	Existing (1970s) vintage
Size	10,000 square feet
Number of floors	2
Wall construction and R-value	Wood frame with brick veneer, R-5
Roof construction and R-value	Wood frame with built-up roof, R-12
Glazing type	Single pane clear
Lighting power density	Perimeter offices: 2.2 W/SF Core offices: 1.5 W/SF
Plug load density	Perimeter offices: 1.6 W/SF Core offices: 0.7 W/SF
Operating hours	Mon-Sat: 9am – 6pm Sun: Unoccupied
HVAC system type	Packaged single zone, no economizer
HVAC system size	230 - 245 SF/ton depending on climate
Thermostat set points	Occupied hours: 76 °F cooling, 72 °F heating Unoccupied hours: 79 °F cooling, 69 °F heating

A computer-generated sketch of the Small Office Building prototype is shown below.

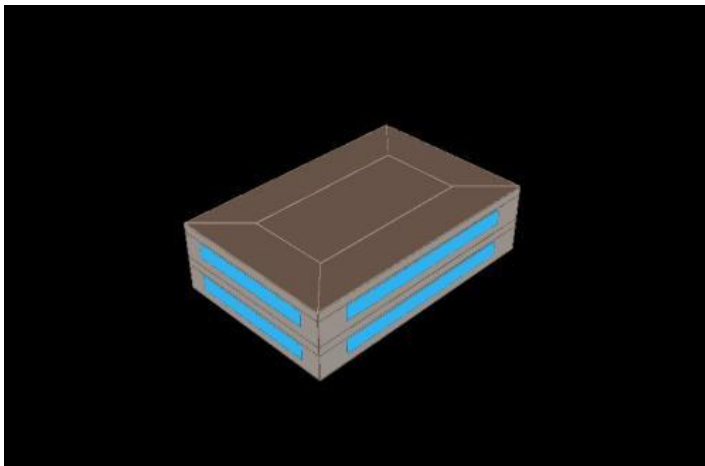

5.19 SMALL RETAIL

A prototypical building energy simulation model for a small retail building was developed using the DOE-2.2 building energy simulation program. The simulations were driven using TMY3 long-term average weather data. The characteristics of the small retail building prototype are summarized below.

SMALL RETAIL PROTOTYPE DESCRIPTION

Characteristic	Value
Vintage	Existing (1970s) vintage
Size	Sales Area: 6400 SF Storage Area: 1600 SF Total: 8000 SF
Number of floors	1
Wall construction and R-value	Concrete block with brick veneer, R-5
Roof construction and R-value	Wood frame with built-up roof, R-12
Glazing type	Single pane clear
Lighting power density	Sales area: 3.4 W/SF Storage area: 0.9 W/SF
Plug load density	Sales area: 1.2 W/SF Storage area: 0.2 W/SF
Operating hours	Mon-Sat: 10 – 10 Sun: 10 – 8
HVAC system type	Packaged single zone, no economizer
HVAC system size	230 – 250 SF/ton depending on climate
Thermostat set points	Occupied hours: 76 °F cooling, 72 °F heating Unoccupied hours: 79 °F cooling, 69 °F heating

A computer-generated sketch of the Small Retail Building prototype is shown below.

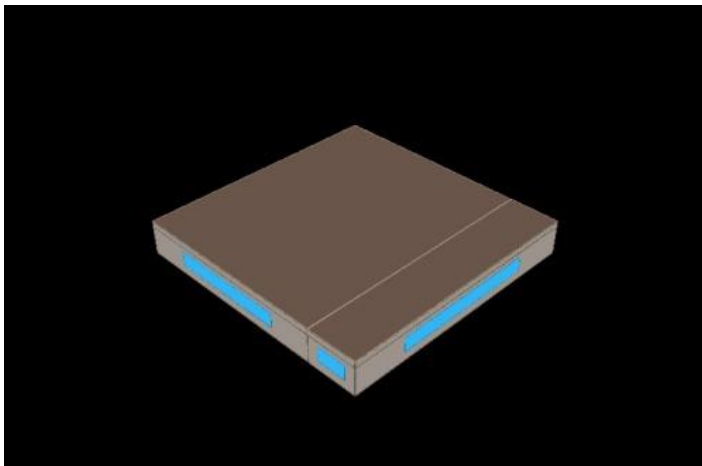

5.20 UNIVERSITY

A prototypical building energy simulation model for a university building was developed using the DOE-2.2 building energy simulation program. The simulations were driven using TMY3 long-term average weather data. The model is really four identical buildings oriented 90 degrees apart. The characteristics of the prototype are summarized below.

UNIVERSITY PROTOTYPE BUILDING DESCRIPTION

Characteristic	Value
Vintage	Existing (1970s) vintage
Size	4 buildings, 200,000 square feet each; oriented 90° from each other Classroom: 431,160 SF Computer room: 27,540 SF Dining area: 24,000 SF Kitchen: 10,500 SF Office: 226,800 SF Total: 800,000 SF
Number of floors	4
Wall construction and R-value	Insulated frame wall with R-7.5
Roof construction and R-value	Wood frame with built-up roof, R-13.5
Glazing type	Double pane clear, SHGC = 0.73; U-value = 0,72
Lighting power density	Classroom: 3.6 W/SF Computer room: 3.6 W/SF Dining area: 1.5 W/SF Office: 2.0 W/SF Kitchen: 3.6 W/SF
Plug load density	Classroom: 1.1 W/SF Computer room: 5.5 W/SF Dining area: 0.6 W/SF Office: 1.6 W/SF Kitchen: 3.3 W/SF
Operating hours	Mon-Fri: 8am – 10pm Sat: 8am – 7pm Sun: closed
HVAC system type	Combination PSZ and built-up with centrifugal chiller and hot water boiler.
HVAC system size	400 SF/ton
Thermostat set points	Occupied hours: 76 °F cooling, 72 °F heating Unoccupied hours: 81 °F cooling, 67 °F heating
Chiller type	Water cooled and air cooled
Chilled water system type	Variable volume with 2 way control valves
Chilled water system control	Constant CHW Temp, 45 °F set point
Boiler type	Hot water, 80% efficiency
Hot water system type	Variable volume with 2 way control valves
Hot water system control	Constant HW Temp, 180 °F set point

Each set of measures was run using each of three different HVAC system configurations: a constant volume reheat system without economizer, a constant volume reheat system with economizer, and a VAV system with

economizer. The constant volume reheat system without economizer represents a system with the most heating and cooling operating hours, while the VAV system with economizer represents a system with the least heating and cooling hours. This presents a range of system loads and energy savings for each measure analyzed.

A computer-generated sketch of the University Building prototype is shown below.

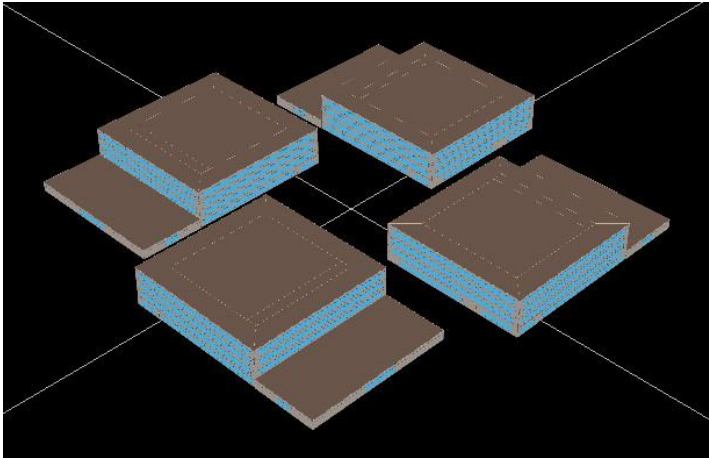

5.21 WAREHOUSE

A prototypical building energy simulation model for a warehouse building was developed using the DOE-2.2 building energy simulation program. The characteristics of the prototype are summarized below.

WAREHOUSE PROTOTYPE BUILDING DESCRIPTION

Characteristic	Value
Vintage	Existing (1970s) vintage
Size	500,000
Number of floors	1
Wall construction and insulation R-value	Concrete block, R-5
Roof construction and insulation R-value	Wood deck with built-up roof, R-12
Glazing type	Multi-pane; Shading-coefficient = 0.84 U-value = 0.72
Lighting power density	0.9 W/SF
Plug load density	0.2 W/SF
Operating hours	Mon-Fri: 7am – 6pm Sat-Sun: Unoccupied
HVAC system type	Packaged single zone, no economizer
HVAC system size	Based on ASHRAE design day conditions, 10% over-sizing assumed.
Thermostat set points	Occupied hours: 80 °F cooling, 68 °F heating Unoccupied hours: 85 °F cooling, 63 °F heating

A computer-generated sketch of the Warehouse Building prototype is shown below.

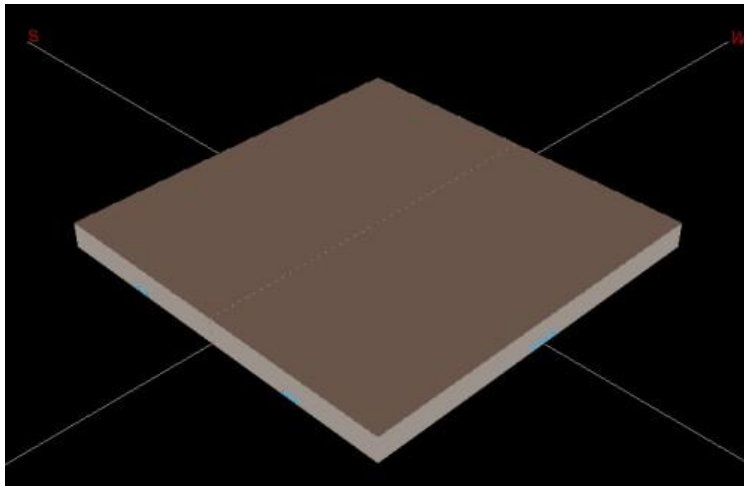

6 APPENDIX C: HEATING AND COOLING EFLH

6.1.1 RESIDENTIAL EFLH

This appendix provides heating and cooling full load hours by home type and vintage. Values are taken from NY TRM v10 for NYC. If home vintage is unknown, assume average.

Table 6-1 Residential Heating and Cooling Full Load Hours

Home Type	Old (built prior to 1979)		Average (built 1979-2006)		New (built 2007-present)	
	Cooling EFLH	Heating EFLH	Cooling EFLH	Heating EFLH	Cooling EFLH	Heating EFLH
Single-family detached	622	846	602	767	585	707
Multi-family low-rise	470	738	510	705	521	491
Multi-family high-rise	736	987	782	513	885	214

6.1.2 C&I BUILDING TYPES

This appendix provides heating and cooling full load hours by building type. A description of each building type is shown in the table below. The primary distinction between small and large buildings is the number of floors and HVAC system type rather than a specific conditioned floor area criterion. Small buildings in this study utilize packaged or split unitary system HVAC systems or packaged terminal air conditioners (PTAC). Large buildings use built-up HVAC systems with chillers and boilers.

Table 6-2 C&I Building Type Descriptions

Building Type	Description
Assembly	Public buildings that include community centers, libraries, performance and movie theaters, auditoria, police and fire stations, gymnasia, sports arenas, and transportation terminals
Auto	Repair shops and auto dealerships, including parking lots and parking structures.
Big Box	Single story, high-bay retail stores with ceiling heights of 25 feet or more. Majority of floor space is dedicated to non-food items, but could include refrigerated and non-refrigerated food sales areas.
Community College	Community college campus and post-secondary technical and vocational education buildings, including classroom, computer labs, dining and office. Conditioned by packaged HVAC systems
Dormitory	College or University dormitories
Fast Food	Self-service restaurants with primarily disposable plates, utensils etc.
Full Service Restaurant	Full service restaurants with full dishwashing facilities
Grocery	Refrigerated and non-refrigerated food sales, including convenience stores and specialty food sales
Heavy Industrial	Single or multistory buildings containing industrial processes including pump stations, water and wastewater treatment plants; may be conditioned or unconditioned.

Building Type	Description
Hospital	Inpatient and outpatient care facility conditioned by built-up HVAC systems. Excludes medical offices
Hotel	Multifunction lodging facility with guest rooms, meeting space, foodservice conditioned by built-up HVAC system
Large Office	Office space in buildings greater than 3 stories conditioned by built-up HVAC system.
Light Industrial	Single story work space with heating and air-conditioning; conditioned by packaged HVAC systems.
Multi-family high-rise	Multi-family building with more than 3 stories conditioned by built up HVAC system
Multi-family low-rise	Multi-family building with 3 stories or less conditioned by packaged HVAC system
Motel	Lodging facilities with primarily guest room space served by packaged HVAC systems
Multi Story Retail	Retail building with 2 or more stories served by built-up HVAC system
Primary School	K-8 school
Religious	Religious worship
Secondary School	9-12 school
Single-family residential	Single-family detached residences
Small Office	Office occupancy in buildings 3 stories or less served by packaged HVAC systems; includes Medical offices
Small Retail	Single story retail with ceiling height of less than 25 feet; primarily non-food retail and storage areas served by packaged HVAC systems. Includes service businesses, post offices, Laundromats, and exercise facilities.
University	University campus buildings, including classroom, computer labs, biological and/or chemical labs, workshop space, dining and office. Conditioned by built-up HVAC systems
Warehouse	Primarily non-refrigerated storage space could include attached offices served by packaged HVAC system.

Other building types not included above can be matched to the standard building types as shown below:

Table 6-3 Building Type Correlation Examples

Building Type	Best Match
Agricultural	Light industrial
Funeral home	Small retail
Police and fire stations	Public assembly
Courthouse	Large office
Detention facility	Multifamily highrise
Municipal airport	Assembly

Building Type	Best Match
Nursing home	Hospital
Kennel	Small retail

Note: for commercial buildings that cannot be reasonably associated with one the building types above, savings values for the “other” category should be used.

6.1.3 C&I EFLH VALUES

Table 6-4 Small Commercial (less than 3 stories) EFLH

Facility Type	HVAC Type	Cooling (EFLH _c)	Heating (EFLH _h)
Assembly	Packaged or split unitary system	693	708
Auto repair	Packaged or split unitary system	452	2,132
Light industrial	Packaged or split unitary system	523	854
Lodging – Motel	Packaged Terminal AC	1,022	437
Office – small	Packaged or split unitary system	904	449
Other	Packaged or split unitary system	766	796
Religious worship	Packaged or split unitary system	322	753
Restaurant – fast food	Packaged or split unitary system	647	958
Restaurant – full service	Packaged or split unitary system	614	964
Retail – big box	Packaged or split unitary system	996	368
Retail – Grocery	Packaged or split unitary system	2,045	971
Retail – small	Packaged or split unitary system	903	626
School – primary	Packaged or split unitary system	388	933
Warehouse	Packaged or split unitary system	367	510

Table 6-5 Large Commercial (more than 3 stories) EFLH

Building Type	HVAC Type	Cooling (EFLH _c)	Heating (EFLH _h)	Building Type	HVAC Type	Cooling (EFLH _c)	Heating (EFLH _h)
Dormitory	Fan coil	852	485				
Hospital	CV econ	1,380	3,980	School – Community College	CV econ	812	1,404
	CV noecon	2,250	4,157		CV noecon	1,089	1,253
	VAV	1,169	416		VAV	596	410
	Unknown	1,273	1,001		Unknown	706	694
Hotel	CV econ	2,886	1,059	School – Secondary	CV econ	482	950
	CV noecon	3,072	786		CV noecon	877	875
	VAV	2,892	297		VAV	358	292
	Unknown	2,979	923		Unknown	457	484
Large Office	CV econ	708	2,136	School – Postsecondary	CV econ	881	1,245
	CV noecon	2,248	2,157		CV noecon	1,160	1,132
	VAV	696	375		VAV	634	592

Building Type	HVAC Type	Cooling (EFLH _c)	Heating (EFLH _h)
	Unknown	805	623
Large Retail	CV econ	1,125	2,058
	CV noecon	1,839	1,989
	VAV	950	681
	Unknown	1,035	895

Building Type	HVAC Type	Cooling (EFLH _c)	Heating (EFLH _h)
	Unknown	753	777
Other	CV econ	1,182	1,833
	CV noecon	1,791	1,764
	VAV	1,042	438
	Unknown	1,144	771

Table 6-6 Multifamily EFLH by Vintage

Facility Type	Prior to 1979	From 1979 to 2006	From 2007 through Present
Low-rise, Cooling	507	550	562
Low-rise, Heating	757	723	503
High-rise, Cooling	793	843	954
High-rise, Heating	526	395	219

7 APPENDIX D: HVAC FAN AND PUMP OPERATING HOURS

This section presents HVAC fan and pump operating hours by C&I building type. These values are the result of building prototype models in Appendix B: Building Prototype Descriptions. The operating hours are differentiated by facility type, HVAC system (large commercial only), and climate region. If climate region is unavailable, default to statewide average values.

Table 7-1 Small Commercial HVAC Fan and Pump Hours

Facility Type	Climate	HVAC Fan Motor	Heating Pumps
Assembly	Central	6,884	3,741
Assembly	Coastal	6,812	3,847
Assembly	Northern	6,877	4,039
Assembly	Pine Barrens	6,784	3,674
Assembly	Southwest	6,861	3,687
Assembly	Statewide Average	6,858	3,795
Auto repair	Central	6,341	4,377
Auto repair	Coastal	6,312	4,463
Auto repair	Northern	6,408	4,683
Auto repair	Pine Barrens	6,311	4,296
Auto repair	Southwest	6,287	4,302
Auto repair	Statewide Average	6,339	4,426
Big box	Central	5,669	2,725
Big box	Coastal	5,429	2,729
Big box	Northern	5,485	2,963
Big box	Pine Barrens	5,641	2,696
Big box	Southwest	5,634	2,697
Big box	Statewide Average	5,592	2,760
Fast food restaurant	Central	6,940	3,958
Fast food restaurant	Coastal	6,854	4,025
Fast food restaurant	Northern	6,893	4,210
Fast food restaurant	Pine Barrens	6,818	3,845
Fast food restaurant	Southwest	6,868	3,895
Fast food restaurant	Statewide Average	6,897	3,992
Full service restaurant	Central	6,002	3,614

Facility Type	Climate	HVAC Fan Motor	Heating Pumps
Full service restaurant	Coastal	5,964	3,693
Full service restaurant	Northern	6,083	3,931
Full service restaurant	Pine Barrens	5,967	3,551
Full service restaurant	Southwest	5,997	3,588
Full service restaurant	Statewide Average	6,005	3,671
Grocery	Central	8,760	8,760
Grocery	Coastal	8,760	8,760
Grocery	Northern	8,760	8,760
Grocery	Pine Barrens	8,760	8,760
Grocery	Southwest	8,760	8,760
Grocery	Statewide Average	8,760	8,760
Light industrial	Central	4,752	2,596
Light industrial	Coastal	4,778	2,781
Light industrial	Northern	4,983	3,044
Light industrial	Pine Barrens	4,733	2,571
Light industrial	Southwest	4,825	2,706
Light industrial	Statewide Average	4,801	2,711
Motel	Central	4,540	2,216
Motel	Coastal	4,540	2,239
Motel	Northern	4,540	2,325
Motel	Pine Barrens	4,540	2,181
Motel	Southwest	4,540	2,188
Motel	Statewide Average	4,540	2,231
Primary school	Central	5,991	4,104
Primary school	Coastal	6,012	4,229
Primary school	Northern	6,080	4,432
Primary school	Pine Barrens	5,917	4,045
Primary school	Southwest	6,011	4,081
Primary school	Statewide Average	6,004	4,171
Religious	Central	3,493	1,915
Religious	Coastal	3,493	1,934
Religious	Northern	3,493	1,957

Facility Type	Climate	HVAC Fan Motor	Heating Pumps
Religious	Pine Barrens	3,493	1,835
Religious	Southwest	3,493	1,877
Religious	Statewide Average	3,493	1,912
Small office	Central	5,423	2,456
Small office	Coastal	5,465	2,567
Small office	Northern	5,615	2,916
Small office	Pine Barrens	5,360	2,391
Small office	Southwest	5,473	2,482
Small office	Statewide Average	5,461	2,548
Small retail	Central	5,767	3,169
Small retail	Coastal	5,767	3,304
Small retail	Northern	5,931	3,544
Small retail	Pine Barrens	5,711	3,118
Small retail	Southwest	5,770	3,196
Small retail	Statewide Average	5,789	3,252
Warehouse	Central	3,604	1,521
Warehouse	Coastal	3,604	1,610
Warehouse	Northern	3,604	1,672
Warehouse	Pine Barrens	3,604	1,489
Warehouse	Southwest	3,604	1,548
Warehouse	Statewide Average	3,604	1,560

Table 7-2 Large Commercial HVAC Fan and Pump Hours

Facility Type	Climate	HVAC System	HVAC Fan Motor	Chilled Water Pump	Hot Water Pump	Condenser Water Pump	Cooling Tower Fan
Community College	Central	CV econ	3,480	2,216	2,780	2,644	878
Community College	Coastal	CV econ	3,480	2,204	2,725	2,640	854
Community College	Northern	CV econ	3,480	2,161	2,826	2,582	697
Community College	Pine Barrens	CV econ	3,480	2,245	2,784	2,679	923
Community College	Southwest	CV econ	3,480	2,166	2,810	2,666	939
Community College	Statewide Average	CV econ	3,480	2,202	2,783	2,639	855
Community College	Central	CV noecon	3,480	2,331	2,738	2,825	964
Community College	Coastal	CV noecon	3,480	2,314	2,684	2,836	942
Community College	Northern	CV noecon	3,480	2,272	2,755	2,767	785
Community College	Pine Barrens	CV noecon	3,480	2,347	2,747	2,844	1,008
Community College	Southwest	CV noecon	3,480	2,271	2,769	2,844	1,027
Community College	Statewide Average	CV noecon	3,480	2,313	2,737	2,821	942
Community College	Central	VAV	2,049	3,364	3,357	2,450	611
Community College	Coastal	VAV	2,121	3,364	3,357	2,415	579
Community College	Northern	VAV	2,173	3,364	3,357	2,360	437
Community College	Pine Barrens	VAV	2,105	3,364	3,357	2,461	639
Community College	Southwest	VAV	2,075	3,364	3,357	2,475	671
Community College	Statewide Average	VAV	2,091	3,364	3,357	2,433	586
Community College	Central	Unknown	2,493	3,026	3,172	2,538	707
Community College	Coastal	Unknown	2,543	3,021	3,155	2,515	678
Community College	Northern	Unknown	2,578	3,008	3,181	2,457	532
Community College	Pine Barrens	Unknown	2,531	3,033	3,173	2,554	740
Community College	Southwest	Unknown	2,511	3,009	3,181	2,562	768
Community College	Statewide Average	Unknown	2,522	3,021	3,172	2,525	683
Dorm	Central	FPFC	3,833	3,824	3,772	2,765	489
Dorm	Coastal	FPFC	3,833	3,824	3,772	2,762	499
Dorm	Northern	FPFC	3,833	3,824	3,772	2,729	359
Dorm	Pine Barrens	FPFC	3,833	3,824	3,772	2,763	486
Dorm	Southwest	FPFC	3,834	3,824	3,772	2,772	485
Dorm	Statewide Average	FPFC	3,833	3,824	3,772	2,759	468

Facility Type	Climate	HVAC System	HVAC Fan Motor	Chilled Water Pump	Hot Water Pump	Condenser Water Pump	Cooling Tower Fan
Dorm	Central	Unknown	3,833	3,824	3,772	2,765	489
Dorm	Coastal	Unknown	3,833	3,824	3,772	2,762	499
Dorm	Northern	Unknown	3,833	3,824	3,772	2,729	359
Dorm	Pine Barrens	Unknown	3,833	3,824	3,772	2,763	486
Dorm	Southwest	Unknown	3,834	3,824	3,772	2,772	485
Dorm	Statewide Average	Unknown	3,833	3,824	3,772	2,759	468
Hospital	Central	CV econ	5,635	6,641	6,372	5,944	1,067
Hospital	Coastal	CV econ	5,588	6,615	6,752	5,904	969
Hospital	Northern	CV econ	5,635	6,632	6,477	5,864	798
Hospital	Pine Barrens	CV econ	5,651	6,624	6,449	5,940	1,023
Hospital	Southwest	CV econ	5,603	6,613	6,680	5,943	1,056
Hospital	Statewide Average	CV econ	5,626	6,630	6,493	5,923	999
Hospital	Central	CV noecon	5,639	6,970	6,808	6,068	1,149
Hospital	Coastal	CV noecon	5,584	6,930	6,789	5,996	1,048
Hospital	Northern	CV noecon	5,627	7,000	6,631	5,993	881
Hospital	Pine Barrens	CV noecon	5,657	6,954	6,897	6,067	1,102
Hospital	Southwest	CV noecon	5,600	6,916	6,581	6,055	1,135
Hospital	Statewide Average	CV noecon	5,626	6,961	6,759	6,042	1,081
Hospital	Central	VAV	5,712	6,656	5,312	5,909	991
Hospital	Coastal	VAV	5,690	6,631	6,137	5,882	906
Hospital	Northern	VAV	5,732	6,619	5,909	5,844	745
Hospital	Pine Barrens	VAV	5,736	6,626	4,730	5,912	957
Hospital	Southwest	VAV	5,704	6,628	5,997	5,912	985
Hospital	Statewide Average	VAV	5,714	6,639	5,557	5,894	931
Hospital	Central	Unknown	5,700	6,680	5,517	5,925	1,009
Hospital	Coastal	Unknown	5,673	6,653	6,238	5,893	922
Hospital	Northern	Unknown	5,716	6,651	6,012	5,857	760
Hospital	Pine Barrens	Unknown	5,723	6,652	5,040	5,927	974
Hospital	Southwest	Unknown	5,687	6,650	6,098	5,926	1,003
Hospital	Statewide Average	Unknown	5,699	6,664	5,728	5,908	949

Facility Type	Climate	HVAC System	HVAC Fan Motor	Chilled Water Pump	Hot Water Pump	Condenser Water Pump	Cooling Tower Fan
Hotel	Central	CV econ	8,664	6,026	7,310	6,992	2,490
Hotel	Coastal	CV econ	8,665	5,744	7,309	6,939	2,347
Hotel	Northern	CV econ	8,668	5,918	7,328	6,839	2,025
Hotel	Pine Barrens	CV econ	8,665	5,772	7,313	6,988	2,438
Hotel	Southwest	CV econ	8,664	6,042	7,306	7,016	2,516
Hotel	Statewide Average	CV econ	8,665	5,936	7,313	6,960	2,385
Hotel	Central	CV noecon	8,664	6,527	7,234	7,967	3,335
Hotel	Coastal	CV noecon	8,665	6,243	7,227	7,940	3,233
Hotel	Northern	CV noecon	8,668	6,424	7,248	7,826	2,850
Hotel	Pine Barrens	CV noecon	8,665	6,249	7,238	7,958	3,284
Hotel	Southwest	CV noecon	8,664	6,539	7,228	7,967	3,336
Hotel	Statewide Average	CV noecon	8,665	6,435	7,235	7,938	3,231
Hotel	Central	VAV	8,619	5,372	6,172	6,857	2,210
Hotel	Coastal	VAV	8,617	5,142	7,179	6,801	2,062
Hotel	Northern	VAV	8,618	5,456	6,178	6,689	1,733
Hotel	Pine Barrens	VAV	8,619	5,593	6,178	6,856	2,150
Hotel	Southwest	VAV	8,619	5,384	7,185	6,875	2,206
Hotel	Statewide Average	VAV	8,619	5,375	6,446	6,822	2,098
Hotel	Central	Unknown	8,664	6,026	7,310	6,992	2,490
Hotel	Coastal	Unknown	8,665	5,744	7,309	6,939	2,347
Hotel	Northern	Unknown	8,668	5,918	7,328	6,839	2,025
Hotel	Pine Barrens	Unknown	8,665	5,772	7,313	6,988	2,438
Hotel	Southwest	Unknown	8,664	6,042	7,306	7,016	2,516
Hotel	Statewide Average	Unknown	8,665	5,936	7,313	6,960	2,385
High School	Central	CV econ	1,953	1,127	1,319	1,644	612
High School	Coastal	CV econ	1,953	1,126	1,322	1,643	595
High School	Northern	CV econ	1,953	1,108	1,351	1,610	518
High School	Pine Barrens	CV econ	1,953	1,142	1,400	1,663	639
High School	Southwest	CV econ	1,953	1,141	1,317	1,654	609
High School	Statewide Average	CV econ	1,953	1,127	1,333	1,641	596

Facility Type	Climate	HVAC System	HVAC Fan Motor	Chilled Water Pump	Hot Water Pump	Condenser Water Pump	Cooling Tower Fan
High School	Central	CV noecon	1,953	1,372	1,311	1,881	855
High School	Coastal	CV noecon	1,953	1,398	1,313	1,882	848
High School	Northern	CV noecon	1,953	1,342	1,259	1,848	768
High School	Pine Barrens	CV noecon	1,953	1,344	1,350	1,875	860
High School	Southwest	CV noecon	1,953	1,335	1,310	1,872	835
High School	Statewide Average	CV noecon	1,953	1,364	1,307	1,874	838
High School	Central	VAV	1,522	1,120	969	1,583	489
High School	Coastal	VAV	1,502	1,132	1,042	1,571	462
High School	Northern	VAV	1,480	1,099	1,007	1,539	384
High School	Pine Barrens	VAV	1,520	1,146	973	1,592	512
High School	Southwest	VAV	1,507	1,141	995	1,581	477
High School	Statewide Average	VAV	1,510	1,124	990	1,574	468
High School	Central	Unknown	1,655	1,160	1,076	1,638	565
High School	Coastal	Unknown	1,642	1,172	1,128	1,631	542
High School	Northern	Unknown	1,627	1,138	1,099	1,598	464
High School	Pine Barrens	Unknown	1,654	1,176	1,098	1,647	585
High School	Southwest	Unknown	1,645	1,171	1,094	1,638	553
High School	Statewide Average	Unknown	1,647	1,161	1,093	1,631	545
Large Office	Central	CV econ	4,956	2,938	2,435	4,273	558
Large Office	Coastal	CV econ	4,966	2,972	2,495	4,328	476
Large Office	Northern	CV econ	4,963	2,922	2,529	4,290	379
Large Office	Pine Barrens	CV econ	4,950	2,967	2,465	4,329	512
Large Office	Southwest	CV econ	4,917	2,973	2,462	4,323	567
Large Office	Statewide Average	CV econ	4,954	2,948	2,467	4,297	510
Large Office	Central	CV noecon	4,955	3,418	2,421	5,076	678
Large Office	Coastal	CV noecon	4,960	3,473	2,479	5,183	605
Large Office	Northern	CV noecon	4,953	3,431	2,512	5,133	499
Large Office	Pine Barrens	CV noecon	4,946	3,435	2,449	5,137	633
Large Office	Southwest	CV noecon	4,904	3,450	2,446	5,134	689
Large Office	Statewide Average	CV noecon	4,949	3,434	2,452	5,116	632

Facility Type	Climate	HVAC System	HVAC Fan Motor	Chilled Water Pump	Hot Water Pump	Condenser Water Pump	Cooling Tower Fan
Large Office	Central	VAV	3,866	2,810	2,268	3,937	289
Large Office	Coastal	VAV	3,862	2,815	2,295	3,957	239
Large Office	Northern	VAV	3,914	2,779	2,338	3,949	182
Large Office	Pine Barrens	VAV	3,900	2,827	2,291	3,964	266
Large Office	Southwest	VAV	3,837	2,848	2,291	3,985	304
Large Office	Statewide Average	VAV	3,874	2,811	2,289	3,951	262
Large Office	Central	Unknown	4,018	2,861	2,290	4,040	335
Large Office	Coastal	Unknown	4,016	2,872	2,322	4,069	282
Large Office	Northern	Unknown	4,060	2,835	2,364	4,056	218
Large Office	Pine Barrens	Unknown	4,047	2,879	2,314	4,072	309
Large Office	Southwest	Unknown	3,987	2,899	2,314	4,089	350
Large Office	Statewide Average	Unknown	4,025	2,865	2,313	4,056	305
Large Retail	Central	CV econ	4,540	2,364	2,183	3,531	1,124
Large Retail	Coastal	CV econ	4,540	2,334	2,181	3,503	1,051
Large Retail	Northern	CV econ	4,540	2,283	2,191	3,457	905
Large Retail	Pine Barrens	CV econ	4,540	2,368	2,184	3,552	1,123
Large Retail	Southwest	CV econ	4,540	2,369	2,185	3,539	1,130
Large Retail	Statewide Average	CV econ	4,540	2,347	2,184	3,517	1,075
Large Retail	Central	CV noecon	4,540	2,633	2,123	3,840	1,314
Large Retail	Coastal	CV noecon	4,540	2,614	2,118	3,813	1,257
Large Retail	Northern	CV noecon	4,540	2,568	2,127	3,774	1,088
Large Retail	Pine Barrens	CV noecon	4,540	2,632	2,125	3,845	1,306
Large Retail	Southwest	CV noecon	4,540	2,637	2,124	3,838	1,315
Large Retail	Statewide Average	CV noecon	4,540	2,619	2,123	3,825	1,266
Large Retail	Central	VAV	4,201	2,276	1,901	3,215	746
Large Retail	Coastal	VAV	4,176	2,251	1,893	3,181	685
Large Retail	Northern	VAV	4,172	2,203	1,910	3,144	560
Large Retail	Pine Barrens	VAV	4,201	2,279	1,901	3,207	732
Large Retail	Southwest	VAV	4,183	2,280	1,898	3,229	750
Large Retail	Statewide Average	VAV	4,190	2,260	1,901	3,198	704

Facility Type	Climate	HVAC System	HVAC Fan Motor	Chilled Water Pump	Hot Water Pump	Condenser Water Pump	Cooling Tower Fan
Large Retail	Central	Unknown	4,255	2,311	1,941	3,291	822
Large Retail	Coastal	Unknown	4,234	2,287	1,934	3,258	760
Large Retail	Northern	Unknown	4,231	2,239	1,950	3,219	630
Large Retail	Pine Barrens	Unknown	4,256	2,315	1,941	3,286	809
Large Retail	Southwest	Unknown	4,240	2,316	1,939	3,303	826
Large Retail	Statewide Average	Unknown	4,246	2,296	1,941	3,274	778
University	Central	CV econ	3,943	2,792	3,318	3,307	1,319
University	Coastal	CV econ	3,943	2,867	3,280	3,292	1,276
University	Northern	CV econ	3,943	2,869	3,311	3,268	1,142
University	Pine Barrens	CV econ	3,943	2,555	3,277	3,336	1,386
University	Southwest	CV econ	3,943	2,850	3,287	3,316	1,360
University	Statewide Average	CV econ	3,943	2,797	3,303	3,302	1,294
University	Central	CV noecon	3,943	3,212	3,228	3,714	1,866
University	Coastal	CV noecon	3,943	3,286	3,240	3,680	1,832
University	Northern	CV noecon	3,943	3,163	3,273	3,652	1,676
University	Pine Barrens	CV noecon	3,943	3,213	3,244	3,679	1,870
University	Southwest	CV noecon	3,943	3,207	3,224	3,693	1,883
University	Statewide Average	CV noecon	3,943	3,215	3,239	3,692	1,830
University	Central	VAV	2,548	2,503	2,977	3,246	1,192
University	Coastal	VAV	2,608	2,368	2,452	3,253	1,175
University	Northern	VAV	2,553	2,503	2,618	3,196	1,002
University	Pine Barrens	VAV	2,642	2,531	2,349	3,275	1,268
University	Southwest	VAV	2,605	2,257	3,116	3,267	1,248
University	Statewide Average	VAV	2,575	2,457	2,778	3,244	1,172
University	Central	Unknown	2,980	2,658	3,069	3,328	1,316
University	Coastal	Unknown	3,021	2,588	2,702	3,325	1,293
University	Northern	Unknown	2,984	2,662	2,827	3,278	1,128
University	Pine Barrens	Unknown	3,045	2,640	2,632	3,347	1,380
University	Southwest	Unknown	3,020	2,496	3,159	3,341	1,364
University	Statewide Average	Unknown	2,999	2,627	2,931	3,322	1,293

8 APPENDIX E: CODE-COMPLIANT EFFICIENCIES

This appendix includes code-compliant efficiencies for HVAC and hot water equipment. These efficiency ratings should be used as baseline parameters according to the following guidelines, unless otherwise specified in the measure:

- When a measure calls for code baseline (TOS/NC), use the current NJ building code. At the time of this writing, NJ building code is defined by ASHRAE 90.1-2019, IECC 2021, and the 2022 Code of Federal Regulations.
- When a measure calls for existing baseline (EREP/RF/ERET), use the actual site-specific efficiency if possible. If the site-specific efficiency unknown, use the code-compliant efficiency from the year of installation. Code-compliant efficiencies from 2013 (10 year vintage) are included here and may be used if the installation year cannot be estimated.

8.1 CONVERTING BETWEEN SEER/SEER2, HSPF/HSPF2

To convert between SEER and SEER2 or HSPF and HSPF2, use the table below (interpolate as needed)

Table 8-1 SEER/SEER2 and HSPF/HSPF2 Conversions

SEER2	SEER	HSPF2	HSPF
13.4	14	6.7	8.0
14.3	15	7.1	8.5
15.2	16	7.5	8.8
16	17	7.8	9.2
17	18	8	9.5
18	19	8.4	10
19	20	8.5	10.2
20	21	8.9	10.8
21	22	9.1	11
22	23	9.3	11.3
23	24	9.7	11.9
		10	12.4
		10.4	12.9

8.2 HVAC EFFICIENCIES

Table 8-2 Minimum A/C and Heat Pump Efficiencies

Equipment Type and Capacity	Heating Type	Cooling Efficiencies		Heating Efficiencies	
		2013 Minimum Efficiency	2019 Minimum Efficiency	2013 Minimum Efficiency	2019 Minimum Efficiency
Air Source Air Conditioners					
< 65,000 Btu/h	All	14 SEER	13.4 SEER2	N/A	N/A
> 65,000 Btu/h and < 135,000 Btu/h	Electric Resistance	11.2 EER, 12.9 IEER	11.2 EER, 14.8 IEER	N/A	N/A
	Other	11.0 EER, 12.7 IEER	11 EER, 14.6 IEER		
≥ 135,000 Btu/h and < 240,000 Btu/h	Electric Resistance	11.0 EER, 12.4 IEER	11 EER, 14.2 IEER	N/A	N/A
	Other	10.8 EER, 12.2 IEER	10.8 EER, 14 IEER		
≥ 240,000 Btu/h and < 760,000 Btu/h	Electric Resistance	10.0 EER, 11.6 IEER	10 EER, 13.2 IEER	N/A	N/A
	Other	9.8 EER, 11.4 IEER	9.8 EER, 13 IEER		
≥ 760,000 Btu/h	Electric Resistance	9.7 EER, 11.2 IEER	9.7 EER, 12.5 IEER	N/A	N/A
	Other	9.5 EER, 11.0 IEER	9.5 EER, 12.3 IEER		
Air Source Heat Pumps					
< 65,000 Btu/h	All	14 SEER	14.3 SEER2 (Split), 13.4 SEER2 (Package)	8.2 HSPF (Split), 8.0 HSPF (Package)	7.5 HSPF2 (Split), 6.7 HSPF2 (Package)
≥ 65,000 Btu/h and < 135,000 Btu/h	Electric Resistance	11 EER, 12.2 IEER	11.0 EER, 14.1 IEER	3.3 COP _H (47F db/43F wb OA) 2.25 COP _H (17F db/15F wb OA)	3.4 COP _H (47F db/43F wb OA) 2.25 COP _H (17F db/15F wb OA)
	Other	10.8 EER, 12.0 IEER	10.8 EER, 13.9 IEER		
≥ 135,000 Btu/h and < 240,000 Btu/h	Electric Resistance	10.6 EER, 11.6 IEER	10.6 EER, 13.5 IEER	3.2 COP _H (47F db/43F wb OA) 2.05 COP _H (17F db/15F wb OA)	3.2 COP _H (47F db/43F wb OA) 2.05 COP _H (17F db/15F wb OA)
	Other	10.4 EER, 11.4 IEER	10.4 EER, 13.3 IEER		
≥ 240,000 Btu/h	Electric Resistance	9.5 EER, 10.6 IEER	9.5 EER, 12.5 IEER	3.2 COP _H (47F db/43F wb OA) 2.05 COP _H (17F db/15F wb OA)	3.2 COP _H (47F db/43F wb OA) 2.05 COP _H (17F db/15F wb OA)
	Other	9.3 EER, 10.4 IEER	9.3 EER, 12.3 IEER		
Water-cooled air conditioner					
< 65,000 Btu/h	All	12.1 EER, 12.3 IEER	12.1 EER, 12.3 IEER	N/A	N/A

Equipment Type and Capacity	Heating Type	Cooling Efficiencies		Heating Efficiencies	
		2013 Minimum Efficiency	2019 Minimum Efficiency	2013 Minimum Efficiency	2019 Minimum Efficiency
≥ 65,000 Btu/h and < 135,000 Btu/h	Electric Resistance	12.1 EER, 13.9 IEER	12.1 EER, 13.9 IEER	N/A	N/A
	Other	11.9 EER, 13.7 IEER	11.9 EER, 13.7 IEER		
≥ 135,000 Btu/h and < 240,000 Btu/h	Electric Resistance	12.5 EER, 13.9 IEER	12.5 EER, 13.9 IEER	N/A	N/A
	Other	12.3 EER, 13.7 IEER	12.3 EER, 13.7 IEER		
≥ 240,000 Btu/h and < 760,000 Btu/h	Electric Resistance	12.4 EER, 13.6 IEER	12.4 EER, 13.6 IEER	N/A	N/A
	Other	12.2 EER, 13.4 IEER	12.2 EER, 13.4 IEER		
≥ 760,000 Btu/h	Electric Resistance	12.2 EER, 13.5 IEER	12.2 EER, 13.5 IEER	N/A	N/A
	Other	12.0 EER, 13.3 IEER	12.0 EER, 13.3 IEER		
Evaporatively-cooled Air Conditioner					
< 65,000 Btu/h	All	12.1 EER, 12.3 IEER	12.1 EER, 12.3 IEER	N/A	N/A
≥ 65,000 Btu/h and < 135,000 Btu/h	Electric Resistance	12.1 EER, 12.3 IEER	12.1 EER, 12.3 IEER	N/A	N/A
	Other	11.9 EER, 12.1 IEER	11.9 EER, 12.1 IEER		
≥ 135,000 Btu/h and < 240,000 Btu/h	Electric Resistance	12.0 EER, 12.2 IEER	12.0 EER, 12.2 IEER	N/A	N/A
	Other	11.8 EER, 12.0 IEER	11.8 EER, 12.0 IEER		
≥ 240,000 Btu/h and < 760,000 Btu/h	Electric Resistance	11.9 EER, 12.1 IEER	11.9 EER, 12.1 IEER	N/A	N/A
	Other	11.7 EER, 11.9 IEER	11.7 EER, 11.9 IEER		
≥ 760,000 Btu/h	Electric Resistance	11.7 EER, 11.9 IEER	11.7 EER, 11.9 IEER	N/A	N/A
	Other	11.5 EER, 11.7 IEER	11.5 EER, 11.7 IEER		

Table 8-3 Minimum Boiler Efficiencies

Boiler Type	Size Category (kBtu input)	2013 Minimum Efficiency	2019 Minimum Efficiency
Hot Water- Gas Fired	<300	82% AFUE	84% AFUE
	≥300 and ≤ 2,500	80% Et	80% Et
	>2,500	82% Ec	82% Ec

Boiler Type	Size Category (kBtu input)	2013 Minimum Efficiency	2019 Minimum Efficiency
Hot Water- Oil Fired	<300	84% AFUE	86% AFUE
	≥300 and ≤ 2,500	82% Et	82% Et
	>2,500	84% Ec	84% Ec
Steam- Gas Fired	<300	80% AFUE	82% AFUE
Steam- Gas Fired All except Natural Draft	≥300 and ≤ 2,500	79% Et	79% Et
	>2,500	79% Et	79% Et
Steam- Gas Fired Natural Draft	≥300 and ≤ 2,500	79% Et	79% Et
	>2,500	79% Et	79% Et
Steam-Oil Fired	<300	82% AFUE	85% AFUE
	≥300 and ≤ 2,500	81% Et	81% Et
	>2,500	81% Et	81% Et

Table 8-4 Minimum Furnace Efficiencies

Furnace Type	Size Category (kBtu input)	2013 Minimum Efficiency	2019 Minimum Efficiency
Gas Fired	< 225	78% AFUE	Nonweatherized 80% AFUE Weatherized 81% AFUE
Gas Fired	≥ 225	80% Ec	81% Et
Oil Fired	< 225	78% AFUE	Nonweatherized excluding mobile home: 83% AFUE Nonweatherized mobile home: 75% AFUE Weatherized: 78% AFUE
Oil Fired	≥ 225	81% Et	82% Et
Gas Fired, Oil Fired	All Capacities	80% Ec	80% Ec

8.3 WATER HEATING EFFICIENCIES

Table 8-5 Minimum UEF Rating (ASHRAE 90.1-2019)

Product Class	Rated Storage Volume and Input Rating	First Hour Rating	UEF ₀
Electric Storage Water Heater	≥ 20 gal and ≤ 55 gal	< 18 gallons	0.8808 – (0.0008 × v _t)
		≥ 18 and < 51 gallons	0.9254 – (0.0003 × v _t)

Product Class	Rated Storage Volume and Input Rating	First Hour Rating	UEF _s
		≥ 51 and < 75 gallons	$0.9307 - (0.0002 \times v_t)$
		≥ 75 gallons	$0.9349 - (0.0001 \times v_t)$
	> 55 gal and ≤ 120 gal	< 18 gallons	$1.9236 - (0.0011 \times v_t)$
		≥ 18 and < 51 gallons	$2.0440 - (0.0011 \times v_t)$
		≥ 51 and < 75 gallons	$2.1171 - (0.0011 \times v_t)$
		≥ 75 gallons	$2.2418 - (0.0011 \times v_t)$
Gas-Fired Storage Water Heater	≥ 20 gal and ≤ 55 gal	< 18 gallons	$0.3456 - (0.0020 \times v_t)$
		≥ 18 and < 51 gallons	$0.5982 - (0.0019 \times v_t)$
		≥ 51 and < 75 gallons	$0.6483 - (0.0017 \times v_t)$
		≥ 75 gallons	$0.6920 - (0.0013 \times v_t)$
	> 55 gal and ≤ 100 gal	< 18 gallons	$0.6470 - (0.0006 \times v_t)$
		≥ 18 and < 51 gallons	$0.7689 - (0.0005 \times v_t)$
		≥ 51 and < 75 gallons	$0.7897 - (0.0004 \times v_t)$
		≥ 75 gallons	$0.8072 - (0.0003 \times v_t)$

9 APPENDIX F: HVAC INTERACTIVITY FACTORS

The values below are taken from NY TRM v10, Appendix D, for NYC. NYC climate is the most similar to a statewide NJ approximation of the NY weather cities. These values are to be used if there is not a measure-specific value presented. If the building and/or HVAC system type is unknown, the default values in Table 9-1 may be used.

Table 9-1 Default Values

HVACc	HVACd	HVACff
0.080	0.175	-0.002

Table 9-2 Residential and Small Commercial

Building Type	AC with fuel heat			Heat Pump			AC with electric heat			Electric heat only			Fuel Heat only		
	HVACc	HVACd	HVACff	HVACc	HVACd	HVACff	HVACc	HVACd	HVACff	HVACc	HVACd	HVACff	HVACc	HVACd	HVACff
Single-Family Residential	0.077	0.085	-0.002	-0.105	0.111	0.000	-0.579	0.085	0.000	-0.403	0.000	0.000	0.000	0.000	-0.002
Multi-family low rise	0.055	0.136	-0.002	-0.064	0.163	0.000	-0.260	0.136	0.000	-0.320	0.000	0.000	-0.005	0.000	-0.002
Assembly	0.160	0.200	-0.002	-0.052	0.200	0.000	-0.243	0.200	0.000	-0.400	0.000	0.000	0.000	0.000	-0.002
Auto Repair	0.076	0.200	-0.004	-0.308	0.200	0.000	-0.795	0.200	0.000	-0.891	0.000	0.000	0.000	0.000	-0.004
Big Box	0.170	0.200	-0.001	0.055	0.200	0.000	-0.065	0.200	0.000	-0.226	0.000	0.000	0.000	0.000	-0.001
Elementary School	0.110	0.200	-0.003	-0.150	0.200	0.000	-0.481	0.200	0.000	-0.646	0.000	0.000	0.000	0.000	-0.003
Fast Food	0.110	0.200	-0.003	-0.471	0.200	0.000	-0.471	0.200	0.000	-0.827	0.000	0.000	0.000	0.000	-0.004
Full Service Restaurant	0.110	0.200	-0.003	-0.486	0.200	0.000	-0.486	0.200	0.000	-0.637	0.000	0.000	0.000	0.000	-0.003
Grocery	0.170	0.200	-0.001	0.055	0.200	0.000	-0.065	0.200	0.000	-0.226	0.000	0.000	0.000	0.000	-0.001
Light Industrial	0.100	0.200	-0.002	-0.083	0.200	0.000	-0.313	0.200	0.000	-0.415	0.000	0.000	0.000	0.000	-0.002
Motel	0.114	0.200	-0.002	-0.155	0.200	0.000	-0.340	0.200	0.000	-0.482	0.000	0.000	0.000	0.000	-0.002
Religious	0.092	0.200	-0.001	-0.060	0.200	0.000	-0.199	0.200	0.000	-0.291	0.000	0.000	0.000	0.000	-0.001
Small Office	0.120	0.200	-0.002	-0.003	0.200	0.000	-0.157	0.200	0.000	-0.239	0.000	0.000	0.000	0.000	-0.001
Small Retail	0.130	0.200	-0.002	-0.044	0.200	0.000	-0.258	0.200	0.000	-0.375	0.000	0.000	0.000	0.000	-0.002
Warehouse	0.078	0.200	-0.002	-0.109	0.200	0.000	-0.273	0.200	0.000	-0.352	0.000	0.000	0.000	0.000	-0.002
Other	0.114	0.200	-0.002	-0.155	0.200	0.000	-0.340	0.200	0.000	-0.482	0.000	0.000	0.000	0.000	-0.002

Table 9-3 Multi-family High Rise and College Dormitory

	Fan coil with chiller and hot water boiler			Steam heat only		
	HVACc	HVACd	HVACff	HVACc	HVACd	HVACff
Multi-family high rise	0.101	0.194	-0.002	0.000	0.000	-0.002
College dormitory	0.025	0.200	-0.001	0.000	0.000	-0.001

Table 9-4 Large Commercial

Facility Type	CV No Econ			CV Econ			VAV Econ		
	HVACc	HVACd	HVACff	HVACc	HVACd	HVACff	HVACc	HVACd	HVACff
Community College	0.044	0.200	-0.003	0.019	0.200	-0.002	0.124	0.200	0.000
High School	0.042	0.200	-0.003	0.022	0.200	-0.003	0.049	0.200	-0.002
Hospital	0.033	0.200	-0.002	0.019	0.200	-0.002	0.065	0.200	-0.001
Hotel	0.033	0.200	-0.002	0.019	0.200	-0.002	0.065	0.200	-0.001
Large Office	0.033	0.200	-0.002	0.019	0.200	-0.002	0.065	0.200	-0.001
Large Retail	0.037	0.200	-0.002	0.023	0.200	-0.002	0.057	0.200	-0.002
University	0.048	0.200	-0.003	0.020	0.200	-0.003	0.142	0.200	-0.001

Table 9-5 Refrigerated Warehouse

Facility Type	Water Cooled Ammonia Screw Compressors	
	HVACc	HVACd
Refrigerated Warehouse	0.390	0.200

10 APPENDIX G: NATURAL GAS PEAK DAY FACTORS

Peak gas savings are calculated on a therm/day basis, using peak day heating degree-days representing the weather conditions under which the natural gas distribution system reaches peak capacity. Design day conditions from the London Economics study are used to calculate peak gas savings:¹⁵⁷

Table 10-1 Design Day Conditions

Condition	Average Heating Degree days base 65 (Deg F – day)	Average Daily Temperature (Deg F)
Winter Design Day	66.4	-1.4

Peak Day Factors (PDF) are defined as the ratio of the gas savings during the gas peak day to the annual gas savings. Peak day factors are defined using one of four methods depending on the measure type:

Table 10-2 Peak Day Factor Methods

Peak Day Factor Method	Definition	Measure Type
1 - day per year ratio	= 1/days per year	Used for non weather sensitive measure that may be in operation for different number of days per year.
2 - FLH ratio	FLH (peak gas day) / Annual FLH	Weather sensitive measures where the annual savings are expressed as a function of heating equivalent full load hours
3 - HDD ratio	HDD peak gas day / Annual HDD	Weather sensitive measures where the annual savings are expressed as a function of heating degree days
4 - hr per year ratio	24 / annual heating hr per year	HVAC interactive effects of lighting or other internal loads on heating energy

10.1 MEASURE LIST

The following Table shows the PDF method assignment and the PDF value or PDF table lookup for each measure in the TRM. Note, if the PDF method is N/A, the measure does not save gas during the peak day and the PDF is zero.

¹⁵⁷ Reference London Economics study

Table 10-3 Residential Measure PDF Method Assignment

End-Use	Measure Name	PDF method	PDF
Appliance Recycling	Dehumidifier recycling	N/A	
Appliance Recycling	Refrigerator & Freezer recycling	N/A	
Appliance Recycling	Room A/C recycling	N/A	
Appliances	Air purifier	N/A	
Appliances	Clothes dryer	1 - day per year ratio	0.002740
Appliances	Clothes washer	1 - day per year ratio	0.002740
Appliances	Dehumidifier	N/A	
Appliances	Dishwasher	1 - day per year ratio	0.002740
Appliances	Freezer	N/A	
Appliances	Range	1 - day per year ratio	0.002740
Appliances	Refrigerator	N/A	
Appliances	Room A/C	N/A	
Appliances	Water cooler	N/A	
HVAC	Boiler controls	N/A	
HVAC	Ceiling fan	N/A	
HVAC	Central AC, Heat Pumps, Mini-Splits, PTAC, PTHP	2 - FLH ratio	See Table 10-8
HVAC	Duct insulation & sealing	2 - FLH ratio	See Table 10-8
HVAC	EC Motors	2 - FLH ratio	See Table 10-8
HVAC	Filter whistle	N/A	
HVAC	Furnace	2 - FLH ratio	See Table 10-8
HVAC	Ground Loop and Air-to-Water Heat Pump	N/A	
HVAC	Heat or energy recovery ventilator	2 - FLH ratio	See Table 10-8
HVAC	Maintenance	2 - FLH ratio	See Table 10-8
HVAC	Smart Thermostat	2 - FLH ratio	See Table 10-8
HVAC	Ventilation fan	N/A	
Lighting	Controls	2 - FLH ratio	See Table 10-8
Lighting	Lamps and fixtures	2 - FLH ratio	See Table 10-8
Plug load	EV charger	N/A	
Plug load	Office equipment	1 - day per year ratio	0.002740
Plug load	Smart strip	N/A	
Plug load	Sound bar	N/A	

End-Use	Measure Name	PDF method	PDF
Plug load	Televisions	N/A	
Shell	Air sealing	3 - HDD ratio	See Table 10-11
Shell	Insulation	3 - HDD ratio	See Table 10-11
Water heating	Faucet aerator	1 - day per year ratio	0.002740
Water heating	Heat pump water heater	1 - day per year ratio	0.002740
Water heating	Indirect water heater	1 - day per year ratio	0.002740
Water heating	Pipe insulation	1 - day per year ratio	0.002740
Water heating	Pool pump	N/A	
Water heating	Storage water heater	1 - day per year ratio	0.002740
Water heating	Tankless water heater	1 - day per year ratio	0.002740
Water heating	Thermostatic showerhead	1 - day per year ratio	0.002740
Water heating	Water heating controls	1 - day per year ratio	0.002740
Whole building	Behavior	2 - FLH ratio	See Table 10-8
Whole building	Home Performance with Energy Star (HPwES)	2 - FLH ratio	See Table 10-8

Table 10-4 Commercial and Industrial Measures PDF Method Assignment

End-Use	Measure Name	PDF method	PDF
Agriculture	Auto Milker Takeoff	N/A	
Agriculture	Dairy pump VFD	N/A	
Agriculture	Dairy Refrigeration Tune-Up	N/A	
Agriculture	Dairy Scroll Compressor	N/A	
Agriculture	Engine Block Heater Timer	N/A	
Agriculture	Heat Reclaimers	1 - day per year ratio	0.002740
Agriculture	Livestock waterer	N/A	
Agriculture	Low pressure irrigation	N/A	
Agriculture	Ventilation fans	N/A	
Appliance Recycling	Dehumidifier Recycling	N/A	
Appliance Recycling	Freezer & Refrigerator Recycling	N/A	

End-Use	Measure Name	PDF method	PDF
Appliance Recycling	Room A/C Unit Recycling	N/A	
Appliance	Clothes dryer	1 - day per year ratio	See Table 10-6
Appliance	Clothes Dryer modulating valve	1 - day per year ratio	See Table 10-6
Appliance	Clothes washer	1 - day per year ratio	See Table 10-6
Appliance	Dehumidifier	N/A	
Appliance	Freezers	N/A	
Appliance	Refrigerators	N/A	
Appliance	Room Air Conditioner	N/A	
Appliance	Water Cooler	N/A	
Foodservice	Dishwashers	1 - day per year ratio	See Table 10-6
Foodservice	Griddles	1 - day per year ratio	See Table 10-6
Foodservice	Holding cabinets	N/A	
Foodservice	Ice Machines	N/A	
HVAC	Advanced Rooftop Controls (ARC)	2 - FLH ratio	See Table 10-9 and Table 10-10
HVAC	Boiler controls	N/A	
HVAC	Boiler economizer	2 - FLH ratio	See Table 10-9 and Table 10-10
HVAC	Central A/C, Air Source Heat Pumps, Mini-Splits, PTAC	N/A	
HVAC	Chillers	N/A	
HVAC	Demand controlled kitchen ventilation	3 - HDD ratio	See Table 10-11
HVAC	Demand controlled ventilation	2 - FLH ratio	See Table 10-9 and Table 10-10
HVAC	EC Motors	4 - hr per year ratio	See Table 10-12 and Table 10-13
HVAC	Economizer controls	N/A	
HVAC	Furnace	2 - FLH ratio	See Table 10-9 and Table 10-10

End-Use	Measure Name	PDF method	PDF
HVAC	Gas chillers	2 - FLH ratio	See Table 10-9 and Table 10-10
HVAC	Geothermal and Water Source Heat Pumps	N/A	
HVAC	Guest Room EMS	2 - FLH ratio	See Table 10-9 and Table 10-10
HVAC	Heat and energy recovery ventilators	2 - FLH ratio	See Table 10-9 and Table 10-10
HVAC	Infrared heating	2 - FLH ratio	See Table 10-9 and Table 10-10
HVAC	Maintenance	2 - FLH ratio	See Table 10-9 and Table 10-10
HVAC	Makeup air unit	2 - FLH ratio	See Table 10-9 and Table 10-10
HVAC	Programmable & Smart Tstats	2 - FLH ratio	See Table 10-9 and Table 10-10
Lighting	Delamping	4 - hr per year ratio	See Table 10-12 and Table 10-13
Lighting	Exit signs	4 - hr per year ratio	See Table 10-12 and Table 10-13
Lighting	Indoor Ag	N/A	
Lighting	LED sign lighting	N/A	
Lighting	Lighting controls	4 - hr per year ratio	See Table 10-12 and Table 10-13
Lighting	Lighting Fixtures	4 - hr per year ratio	See Table 10-12 and Table 10-13
Motors and Drives	Motors	N/A	
Motors and Drives	VFD	N/A	
Plug Load	EV charger	N/A	
Plug Load	Network Power Management	N/A	
Plug Load	Office Equipment	N/A	
Plug Load	Smart strip	N/A	
Plug Load	UPS	N/A	
Plug Load	Vending Machine	N/A	
Plug Load	Vending machine controls	N/A	

End-Use	Measure Name	PDF method	PDF
Process	Air Compressor	N/A	
Refrigeration	Anti-Sweat Heat Control	N/A	
Refrigeration	Case doors	N/A	
Refrigeration	Case light sensor	N/A	
Refrigeration	Defrost controls	N/A	
Refrigeration	Door closer	N/A	
Refrigeration	Door gaskets	N/A	
Refrigeration	Evaporator fan control	N/A	
Refrigeration	Evaporator fan EC motor	N/A	
Refrigeration	Floating head pressure	N/A	
Refrigeration	LED case lighting	N/A	
Refrigeration	Night covers	1 - day per year ratio	See Table 10-6
Refrigeration	Strip curtains	1 - day per year ratio	See Table 10-6
Refrigeration	System controller	N/A	
Refrigeration	VFD compressor	N/A	
Water heating	Aerators & Showerheads	1 - day per year ratio	See Table 10-6
Water heating	Combi boiler	2 - FLH ratio	See Table 10-9 and Table 10-10
Water heating	Heat pump water heater	1 - day per year ratio	See Table 10-6
Water heating	Pipe insulation	1 - day per year ratio	See Table 10-6
Water heating	PRSV	1 - day per year ratio	See Table 10-6
Water heating	Recirc pump	1 - day per year ratio	See Table 10-6
Water heating	Storage water heater	1 - day per year ratio	See Table 10-6
Water heating	Tankless water heater	1 - day per year ratio	See Table 10-6
Whole Building	Custom	2 - FLH ratio	See Table 10-9 and Table 10-10

End-Use	Measure Name	PDF method	PDF
Whole Building	Operator training	N/A	

10.2 TYPE 1 – DAYS PER YEAR RATIO

The days per year ratio method is used for non-weather sensitive measures and is defined as follows:

$$\text{PDF} = 1/\text{operating days per year}$$

Note the default value is 365 days per year. Operating days per year for Residential and Commercial/Industrial building types and the associated peak day factor is shown in the Tables below:

Table 10-5 Peak Day Factors for Residential Buildings Using the Day per Year Ratio Method

Building Type	Prototype Operation Description	Operating Days/Wk	Operating Wk/Yr	Holidays	Operating Days/Yr	PDF
Single Family	24/7 – 365 days	7	52	0	365	0.00274
Multi-Family Low Rise	24/7 – 365 days	7	52	0	365	0.00274
Multi-Family High- Rise	24/7 – 365 days	7	52	0	365	0.00274

Table 10-6 Peak Day Factors for Commercial and Industrial Buildings Using the Day Per Year Ratio

Building Type	Prototype Operation Description	Operating Days/Wk	Operating Wk/Yr	Holidays	Operating Days/Yr	PDF
Agricultural	24/7 – 365 days	7	52	0	365	0.00274
Assembly	Mon-Sun: 8am – 9pm	7	52	10	355	0.002817
Auto	Mon-Sun: 9am – 9pm	7	52	10	355	0.002817
Big Box	Mon-Sun: 10am – 9pm	7	52	10	355	0.002817
Community College	Mon-Fri: 8am – 7pm Sat: 8am – 4pm Sun: closed	6	49	10	284	0.003521
Dormitory	24/7 – 365 days	7	52	10	355	0.002817
Fast Food	Mon-Sun: 6am – 11pm	7	52	10	355	0.002817
Full Service Restaurant	9am – 12am	6	52	10	303	0.003302
Grocery	Mon-Sun: 6am – 10pm	7	52	0	365	0.00274
Hospital	24/7, 365	7	52	0	365	0.00274
Hotel	Rooms: 60% occupied, 40% unoccupied All others: 24 hr / day	7	52	0	365	0.00274

Building Type	Prototype Operation Description	Operating Days/Wk	Operating Wk/Yr	Holidays	Operating Days/Yr	PDF
Large Office	Mon-Sat: 9am – 6pm Sun: Unoccupied	6	52	10	303	0.003302
Light Industrial	Mon-Fri: 6am – 6pm Sat Sun: Unoccupied	5	52	10	251	0.003989
Motel	24/7 - 365	7	52	0	365	0.00274
Multi-story Retail	Mon-Sat: 9am – 10pm Sun: 9am – 7pm	7	52	10	355	0.002817
Primary School	Mon-Fri: 8am – 6pm Sun: 8am – 4pm	6	38	10	218	0.004587
Religious	Mon-Sat: 12pm-6pm Sun: 9am-7pm	7	52	10	355	0.002817
Secondary School	Mon-Fri: 8am – 7pm Sat: 8am – 4pm Sun: closed	6	38	10	218	0.004587
Small Office	Mon-Sat: 9am – 6pm Sun: Unoccupied	6	52	10	303	0.003302
Small Retail	Mon-Sat: 10 – 10 Sun: 10 – 8	7	52	10	355	0.002817
University	Mon-Fri: 8am – 10pm Sat: 8am – 7pm Sun: closed	6	49	10	284	0.003521
Warehouse	Mon-Fri: 7am – 6pm Sat-Sun: Unoccupied	5	52	10	251	0.003989

10.3 TYPE 2 – FULL LOAD HOUR RATIO

The full load hour method is used for weather sensitive measures where the annual savings are expressed as a function of heating equivalent full load hours. The PDF using this method is defined as:

$$\text{PDF} = \text{FLH (peak gas day)} / \text{Annual FLH}$$

The heating equivalent full load hours are calculated based on the assumed oversizing fraction at the ASHRAE heating design temperature for each climate zone and the peak gas day average daily temperature. The amount of heating system oversizing is assumed to vary linearly with the difference between the building heating base temperature and the outdoor temperature. The system oversizing and the number of heating equivalent full load hours during the peak gas day are shown in the Table below:

Table 10-7 Full Load Hours during the Peak Gas Day

Parameter	Northern	Central	Pine Barrens	Southwest	Coastal	Statewide Average
ASHRAE 1% Heating Design Temperature	6	7	3	10	14	
Heating base temperature	65	65	65	65	65	
Peak Gas Design Temperature	-1.4	-1.4	-1.4	-1.4	-1.4	
Oversizing Factor at ASHRAE Design Temperature	1.2	1.2	1.2	1.2	1.2	
Oversizing Factor at Peak Gas Design Temperature	1.07	1.05	1.12	0.99	0.92	
Peak Gas Day Full Load Hours	22.5	22.9	21.4	24.0	24.0	23.0

Residential PDFs are defined as shown in the Table below:

Table 10-8 Residential Building PDFs Using the Full Load Hour Method

Facility Type	Northern	Central	Pine Barrens	Southwest	Coastal	Statewide Average
Single Family	0.023446	0.023851	0.022312	0.025	0.025	0.023923
Multi Family Low Rise						
Multi Family High Rise						

The PDFs by commercial building type and climate zone are calculated from the heating full load hours shown in Appendix C: . The PDFs associated with small commercial buildings by climate zone are shown below:

Table 10-9 Small Commercial Building PDFs using the Full Load Hour Method

Facility Type	Northern	Central	Pine Barrens	Southwest	Coastal	SW average
Assembly	0.02906	0.03437	0.03282	0.03413	0.03016	0.03244
Auto repair	0.00943	0.01113	0.01029	0.01148	0.01121	0.01077
Dormitory	0.03899	0.05067	0.04547	0.05187	0.04759	0.04736
Light industrial	0.02157	0.02949	0.02788	0.02775	0.02589	0.02687
Lodging – Motel	0.04320	0.05674	0.05163	0.05894	0.05018	0.05254
Office – small	0.03844	0.05627	0.05021	0.05929	0.05090	0.05109
Other	0.02462	0.03057	0.02889	0.03058	0.02817	0.02883
Religious worship	0.02689	0.03150	0.03016	0.03245	0.03095	0.03050
Restaurant – fast food	0.02050	0.02561	0.02482	0.02504	0.02272	0.02396

Facility Type	Northern	Central	Pine Barrens	Southwest	Coastal	SW average
Restaurant – full service	0.02055	0.02534	0.02420	0.02519	0.02262	0.02380
Retail – big box	0.05236	0.06632	0.06460	0.06699	0.06025	0.06240
Retail – Grocery	0.02203	0.02508	0.02487	0.02407	0.02105	0.02364
Retail – small	0.02940	0.03941	0.03692	0.03971	0.03662	0.03665
School – primary	0.02124	0.02622	0.02521	0.02540	0.02355	0.02460
Warehouse	0.03736	0.04709	0.04432	0.04789	0.04750	0.04500

Table 10-10 Large Commercial Building PDFs using the Full Load Hour Method

Facility Type	HVAC System	Northern	Central	Pine Barrens	Southwest	Coastal	SW average
Community college	CV econ	0.01500	0.01670	0.01549	0.01617	0.01767	0.01550
	CV noecon	0.01680	0.01886	0.01722	0.01787	0.01971	0.01731
	VAV	0.04677	0.05876	0.06401	0.04717	0.06348	0.04990
	Unknown	0.02914	0.03419	0.03357	0.03041	0.03635	0.03051
High school	CV econ	0.02326	0.02413	0.02334	0.02707	0.02400	0.02408
	CV noecon	0.02482	0.02638	0.02538	0.02886	0.02627	0.02584
	VAV	0.06197	0.09023	0.07910	0.07765	0.07338	0.06963
	Unknown	0.04159	0.05013	0.04657	0.05004	0.04595	0.04475
Hospital	CV econ	0.00497	0.00618	0.00534	0.00607	0.00574	0.00535
	CV noecon	0.00476	0.00558	0.00498	0.00647	0.00615	0.00517
	VAV	0.04240	0.06126	0.05741	0.05824	0.05347	0.04869
	Unknown	0.01897	0.02440	0.02189	0.02502	0.02344	0.02098
Hotel	CV econ	0.02071	0.02377	0.02198	0.02282	0.01762	0.02164
	CV noecon	0.02707	0.03211	0.02932	0.03111	0.02419	0.02871
	VAV	0.06579	0.08427	0.07278	0.09111	0.07017	0.07294
	Unknown	0.02346	0.02732	0.02513	0.02632	0.02039	0.02468
Large Office	CV econ	0.00992	0.01097	0.01006	0.01207	0.01075	0.01045
	CV noecon	0.00978	0.01090	0.01000	0.01201	0.01053	0.01034
	VAV	0.05415	0.06252	0.05692	0.08673	0.05746	0.06020
	Unknown	0.03323	0.03765	0.03441	0.04641	0.03555	0.03603
Large Retail	CV econ	0.01080	0.01127	0.01055	0.01172	0.01125	0.01101
	CV noecon	0.01127	0.01171	0.01087	0.01205	0.01148	0.01143

Facility Type	HVAC System	Northern	Central	Pine Barrens	Southwest	Coastal	SW average
	VAV	0.03100	0.03548	0.03388	0.03706	0.03048	0.03301
	Unknown	0.02404	0.02659	0.02517	0.02768	0.02402	0.02518
University	CV econ	0.01645	0.01836	0.01830	0.02045	0.01983	0.01762
	CV noecon	0.01713	0.02066	0.02002	0.02220	0.02210	0.01877
	VAV	0.04307	0.03250	0.06014	0.03071	0.06146	0.03952
	Unknown	0.02900	0.02690	0.03612	0.02700	0.03838	0.02897

10.4 TYPE 3 – HEATING DEGREE-DAY RATIO

The Heating Degree Day Ratio Method is used for weather sensitive measures where the annual savings are expressed as a function of heating degree days. The PDF is define as:

$$PDF = HDD \text{ peak gas day} / \text{Annual HDD}$$

Annual degree day data for each of the NJ climate zones along with the daily HDD during the peak day and the associated PDFs are shown in the table below:

Table 10-11 Peak Day Factors Using the Degree Day Ratio Method

	Climate zone					
	Northern	Central	Pine barrens	Southwest	Coastal	SW Average
Annual HDD(65)	4,049	3,971	3,756	3,930	3,484	3,878
Gas Peak Day HDD(65)	66.4	66.4	66.4	66.4	66.4	66.4
PDF	0.016398	0.016723	0.017676	0.016896	0.01906	0.017122

10.5 TYPE 4 – HOURS PER YEAR RATIO

The hours per year ratio method is based on the ratio of the number of heating system operating hours during the peak gas day to the annual number of heating system operating hours. This method is used to calculate PDFs for HVAC interactive effects of lighting or other internal loads on heating energy. The PDF is defined as:

$$PDF = 24 / \text{annual heating hr per year}$$

Heating system operating hours by building type and climate zone are shown in the Tables below:

Table 10-12 Heating System Operating Hours and Peak Day Factors for Small Commercial Buildings

Building	Climate	Heating Hours	PDF
Assembly	Central	3,741	0.006415

Building	Climate	Heating Hours	PDF
Assembly	Coastal	3,847	0.006239
Assembly	Northern	4,039	0.005942
Assembly	Pine Barrens	3,674	0.006532
Assembly	Southwest	3,687	0.006509
Assembly	Statewide Average	3,795	0.006324
Auto repair	Central	4,377	0.005483
Auto repair	Coastal	4,463	0.005378
Auto repair	Northern	4,683	0.005125
Auto repair	Pine Barrens	4,296	0.005587
Auto repair	Southwest	4,302	0.005579
Auto repair	Statewide Average	4,426	0.005423
Big box	Central	2,725	0.008807
Big box	Coastal	2,729	0.008794
Big box	Northern	2,963	0.0081
Big box	Pine Barrens	2,696	0.008902
Big box	Southwest	2,697	0.008899
Big box	Statewide Average	2,760	0.008696
Fast food restaurant	Central	3,958	0.006064
Fast food restaurant	Coastal	4,025	0.005963
Fast food restaurant	Northern	4,210	0.005701
Fast food restaurant	Pine Barrens	3,845	0.006242
Fast food restaurant	Southwest	3,895	0.006162
Fast food restaurant	Statewide Average	3,992	0.006012
Full service restaurant	Central	3,614	0.006641
Full service restaurant	Coastal	3,693	0.006499
Full service restaurant	Northern	3,931	0.006105
Full service restaurant	Pine Barrens	3,551	0.006759
Full service restaurant	Southwest	3,588	0.006689
Full service restaurant	Statewide Average	3,671	0.006538
Grocery	Central	8,760	0.00274
Grocery	Coastal	8,760	0.00274
Grocery	Northern	8,760	0.00274

Building	Climate	Heating Hours	PDF
Grocery	Pine Barrens	8,760	0.00274
Grocery	Southwest	8,760	0.00274
Grocery	Statewide Average	8,760	0.00274
Light industrial	Central	2,596	0.009245
Light industrial	Coastal	2,781	0.00863
Light industrial	Northern	3,044	0.007884
Light industrial	Pine Barrens	2,571	0.009335
Light industrial	Southwest	2,706	0.008869
Light industrial	Statewide Average	2,711	0.008852
Motel	Central	2,216	0.01083
Motel	Coastal	2,239	0.010719
Motel	Northern	2,325	0.010323
Motel	Pine Barrens	2,181	0.011004
Motel	Southwest	2,188	0.010969
Motel	Statewide Average	2,231	0.010756
Primary school	Central	4,104	0.005848
Primary school	Coastal	4,229	0.005675
Primary school	Northern	4,432	0.005415
Primary school	Pine Barrens	4,045	0.005933
Primary school	Southwest	4,081	0.005881
Primary school	Statewide Average	4,171	0.005754
Religious	Central	1,915	0.012533
Religious	Coastal	1,934	0.01241
Religious	Northern	1,957	0.012264
Religious	Pine Barrens	1,835	0.013079
Religious	Southwest	1,877	0.012786
Religious	Statewide Average	1,912	0.012551
Small office	Central	2,456	0.009772
Small office	Coastal	2,567	0.009349
Small office	Northern	2,916	0.00823
Small office	Pine Barrens	2,391	0.010038
Small office	Southwest	2,482	0.00967

Building	Climate	Heating Hours	PDF
Small office	Statewide Average	2,548	0.00942
Small retail	Central	3,169	0.007573
Small retail	Coastal	3,304	0.007264
Small retail	Northern	3,544	0.006772
Small retail	Pine Barrens	3,118	0.007697
Small retail	Southwest	3,196	0.007509
Small retail	Statewide Average	3,252	0.007381
Warehouse	Central	1,521	0.015779
Warehouse	Coastal	1,610	0.014907
Warehouse	Northern	1,672	0.014354
Warehouse	Pine Barrens	1,489	0.016118
Warehouse	Southwest	1,548	0.015504
Warehouse	Statewide Average	1,560	0.015381

Table 10-13 Heating System Operating Hours and Peak Day Factors for Large Commercial buildings

Building	System	Climate	Heating hours	PDF
Community College	Any	Statewide Average	3,364	0.007135
Dorm	Any	Statewide Average	3,824	0.006276
Hospital	Any	Statewide Average	8,756	0.002741
Hotel	Any	Statewide Average	8,665	0.00277
High School	Any	Statewide Average	1,947	0.01233
Large Office	Any	Statewide Average	5,516	0.004351
Large Retail	Any	Statewide Average	4,540	0.005287
University	Any	Statewide Average	3,833	0.006262

11 APPENDIX H: NET-TO-GROSS FACTORS

11.1 COMMERCIAL NTG

Measure	Unique ID #	End Use	Measure Group	PA	Fuel Type	Delivery Mode	NTG 2024	NTG 2025	NTG 2026	NTG Basis	Method	Variation
Auto Milker Takeoff	CC18001	Agriculture	Agriculture		Electric	Down-stream	0.95	0.95	0.95	Evaluator Assigned based on market data	10. Evaluator Assigned	i. Broad Market Trends
Dairy Scroll Compressor	CC18002	Agriculture	Agriculture		Electric	Down-stream	0.95	0.95	0.95	Evaluator Assigned based on market data	10. Evaluator Assigned	i. Broad Market Trends
HE Ventilation Fans	CC18003	Agriculture	Agriculture		Electric	Down-stream	0.95	0.95	0.95	Evaluator Assigned based on market data	10. Evaluator Assigned	i. Broad Market Trends
Heat Reclaimers	CC18004	Agriculture	Agriculture		Electric	Down-stream	0.95	0.95	0.95	Evaluator Assigned based on market data	10. Evaluator Assigned	i. Broad Market Trends
High Volume Low Speed Fans (Destratification)	CC18005	Agriculture	Agriculture		Electric	Down-stream	0.95	0.95	0.95	Evaluator Assigned based on market data	10. Evaluator Assigned	i. Broad Market Trends
Livestock Waterer	CC18006	Agriculture	Agriculture		Electric	Down-stream	0.95	0.95	0.95	Evaluator Assigned based on market data	10. Evaluator Assigned	i. Broad Market Trends
Dairy Vac Pump VSD Controls	CC18007	Agriculture	Agriculture		Electric	Down-stream	0.95	0.95	0.95	Evaluator Assigned based on market data	10. Evaluator Assigned	i. Broad Market Trends
Low Pressure Irrigation	CC18008	Agriculture	Agriculture		Electric	Down-stream	0.95	0.95	0.95	Evaluator Assigned based on market data	10. Evaluator Assigned	i. Broad Market Trends
Dairy Refrigeration Tune-Up	CC18009	Agriculture	Agriculture		Electric	Down-stream	0.95	0.95	0.95	Evaluator Assigned based on market data	10. Evaluator Assigned	i. Broad Market Trends

Measure	Unique ID #	End Use	Measure Group	PA	Fuel Type	Delivery Mode	NTG 2024	NTG 2025	NTG 2026	NTG Basis	Method	Variation
Engine Block Heater Timer	CC18010	Agriculture	Agriculture		Electric	Down-stream	0.95	0.95	0.95	Evaluator Assigned based on market data	10. Evaluator Assigned	i. Broad Market Trends
Building Operations Training	C60001	General	Building Operations Training		Electric	Down-stream	0.95	0.95	0.95	Evaluator Assigned based on market data	10. Evaluator Assigned	i. Broad Market Trends
Building Operations Training	C60001	General	Building Operations Training		Natural Gas	Down-stream	0.95	0.95	0.95	Evaluator Assigned based on market data	10. Evaluator Assigned	i. Broad Market Trends
Building Tune Up	C50001	General	Building Tune Up		Natural Gas	Down-stream	0.96	0.96	0.96	Median of 2 RCx gas program values from literature review	9. Program Level Same Delivery Mode	None
Building Tune Up	C50001	General	Building Tune Up		Electric	Down-stream	0.75	0.75	0.75	Median of 3 electric RCx program values from literature review	9. Program Level Same Delivery Mode	None
Air-Cooled Chiller with Condenser	CV7051	HVAC	Chillers		Electric	Down-stream	0.77	0.77	0.77	Median of 9 values from literature review	9. Program Level Same Delivery Mode	None
Water-Cooled Screw Chiller & Reciprocating Chillers	CV7052	HVAC	Chillers		Electric	Down-stream	0.77	0.77	0.77	Median of 9 values from literature review	9. Program Level Same Delivery Mode	None
Water-Cooled Centrifugal Chillers	CV7053	HVAC	Chillers		Electric	Down-stream	0.77	0.77	0.77	Median of 9 values from literature review	9. Program Level Same Delivery Mode	None
Air-Cooled Chiller with Condenser	CV7054	HVAC	Chillers with a VFD		Electric	Down-stream	0.77	0.77	0.77	Median of 9 values from literature review	9. Program Level Same Delivery Mode	None

Measure	Unique ID #	End Use	Measure Group	PA	Fuel Type	Delivery Mode	NTG 2024	NTG 2025	NTG 2026	NTG Basis	Method	Variation
Water-Cooled Screw and Reciprocating Chillers	CV7055	HVAC	Chillers with a VFD		Electric	Down-stream	0.77	0.77	0.77	Median of 9 values from literature review	9. Program Level Same Delivery Mode	None
Water-Cooled Centrifugal Chillers	CV7056	HVAC	Chillers with a VFD		Electric	Down-stream	0.77	0.77	0.77	Median of 9 values from literature review	9. Program Level Same Delivery Mode	None
Gas Absorption Chillers, < 100 tons	CV7057	HVAC	Chillers with a VFD		Natural Gas	Down-stream	0.90	0.90	0.90	Evaluator Assigned based on market data	10. Evaluator Assigned	i. Broad Market Trends
Gas Absorption Chillers, > 400 tons	CV7058	HVAC	Chillers with a VFD		Natural Gas	Down-stream	0.90	0.90	0.90	Evaluator Assigned based on market data	10. Evaluator Assigned	i. Broad Market Trends
Gas Absorption Chillers, 100 to 400 tons	CV7059	HVAC	Chillers with a VFD		Natural Gas	Down-stream	0.90	0.90	0.90	Evaluator Assigned based on market data	10. Evaluator Assigned	i. Broad Market Trends
Gas Engine Driven Chillers	CV7060	HVAC	Chillers with a VFD		Natural Gas	Down-stream	0.90	0.90	0.90	Evaluator Assigned based on market data	10. Evaluator Assigned	i. Broad Market Trends
Gas Fired Low Intensity Infrared Heating <100MBH	CV7061	HVAC	Chillers with a VFD		Natural Gas	Down-stream	0.64	0.64	0.64	Median of 2 programs with non-specific gas heating measures values from literature review	6. Similar Measure All Delivery Modes	None
Gas Fired Low Intensity Infrared Heating >100MBH	CV7062	HVAC	Chillers with a VFD		Natural Gas	Down-stream	0.64	0.64	0.64	Median of 2 programs with non-specific gas heating measures values from literature review	6. Similar Measure All Delivery Modes	None
Clotheswasher CEE Tier 1	CA2001	Appliances	Clotheswasher		Electric	Down-stream	0.51	0.51	0.51	Median of 3 values from literature	4. Multiple Directly Comparable Sources	a. Removed Outliers

Measure	Unique ID #	End Use	Measure Group	PA	Fuel Type	Delivery Mode	NTG 2024	NTG 2025	NTG 2026	NTG Basis	Method	Variation
Clotheswasher CEE Tier 2	CA2002	Appliances	Clotheswasher		Electric	Down-stream	0.51	0.51	0.51	Median of 3 values from literature	4. Multiple Directly Comparable Sources	a. Removed Outliers
Convection Ovens	CK17019	Kitchen Equipment	Combination and Convection Ovens		Natural Gas	Down-stream	0.81	0.81	0.81	Median of 9 food services program value from literature review	9. Program Level Same Delivery Mode	None
Combination Ovens	CK17020	Kitchen Equipment	Combination and Convection Ovens		Electric	Down-stream	0.81	0.81	0.81	Median of 9 food services program value from literature review	9. Program Level Same Delivery Mode	None
Commercial Combination Oven/Steamer	CK17021	Kitchen Equipment	Combination and Convection Ovens		Natural Gas	Down-stream	0.81	0.81	0.81	Median of 9 food services program value from literature review	9. Program Level Same Delivery Mode	None
Commercial Conveyor Oven	CK17022	Kitchen Equipment	Combination and Convection Ovens		Natural Gas	Down-stream	0.81	0.81	0.81	Median of 9 food services program value from literature review	9. Program Level Same Delivery Mode	None
Dishwasher, Under Counter	CK17001	Kitchen Equipment	Commercial Dishwashers		Electric	Down-stream	0.81	0.81	0.81	Median of 9 food services program value from literature review	9. Program Level Same Delivery Mode	None
Dishwasher, Door Type	CK17002	Kitchen Equipment	Commercial Dishwashers		Electric	Down-stream	0.81	0.81	0.81	Median of 9 food services program value from literature review	9. Program Level Same Delivery Mode	None
Dishwasher, Single Tank Conveyor	CK17003	Kitchen Equipment	Commercial Dishwashers		Electric	Down-stream	0.81	0.81	0.81	Median of 9 food services program value from literature review	9. Program Level Same Delivery Mode	None

Measure	Unique ID #	End Use	Measure Group	PA	Fuel Type	Delivery Mode	NTG 2024	NTG 2025	NTG 2026	NTG Basis	Method	Variation
Dishwasher, Multi Tank Conveyor	CK17004	Kitchen Equipment	Commercial Dishwashers		Electric	Down-stream	0.81	0.81	0.81	Median of 9 food services program value from literature review	9. Program Level Same Delivery Mode	None
Commercial Dishwashers, Door Type High Temp	CK17005	Kitchen Equipment	Commercial Dishwashers		Natural Gas	Down-stream	0.81	0.81	0.81	Median of 9 food services program value from literature review	9. Program Level Same Delivery Mode	None
Commercial Dishwashers, Door Type Low Temp	CK17006	Kitchen Equipment	Commercial Dishwashers		Natural Gas	Down-stream	0.81	0.81	0.81	Median of 9 food services program value from literature review	9. Program Level Same Delivery Mode	None
Commercial Dishwashers, Multiple Tank Conveyor, High Temp	CK17007	Kitchen Equipment	Commercial Dishwashers		Natural Gas	Down-stream	0.81	0.81	0.81	Median of 9 food services program value from literature review	9. Program Level Same Delivery Mode	None
Commercial Dishwashers, Multiple Tank Conveyor, Low Temp	CK17008	Kitchen Equipment	Commercial Dishwashers		Natural Gas	Down-stream	0.81	0.81	0.81	Median of 9 food services program value from literature review	9. Program Level Same Delivery Mode	None
Commercial Dishwashers, Single Tank Conveyor, High Temp	CK17009	Kitchen Equipment	Commercial Dishwashers		Natural Gas	Down-stream	0.81	0.81	0.81	Median of 9 food services program value from literature review	9. Program Level Same Delivery Mode	None
Commercial Dishwashers, Single Tank Conveyor, Low Temp	CK17010	Kitchen Equipment	Commercial Dishwashers		Natural Gas	Down-stream	0.81	0.81	0.81	Median of 9 food services program value from literature review	9. Program Level Same Delivery Mode	None
Commercial Dishwashers, Under Counter High Temp	CK17011	Kitchen Equipment	Commercial Dishwashers		Natural Gas	Down-stream	0.81	0.81	0.81	Median of 9 food services program value from literature review	9. Program Level Same Delivery Mode	None

Measure	Unique ID #	End Use	Measure Group	PA	Fuel Type	Delivery Mode	NTG 2024	NTG 2025	NTG 2026	NTG Basis	Method	Variation
Commercial Dishwashers, Under Counter Low Temp	CK17012	Kitchen Equipment	Commercial Dishwashers		Natural Gas	Downstream	0.81	0.81	0.81	Median of 9 food services program value from literature review	9. Program Level Same Delivery Mode	None
Food Service - Midstream	CK17035	Kitchen Equipment	Commercial Kitchen Equipment		Electric	Midstream	0.81	0.81	0.81	Median of 9 food services program value from literature review	9. Program Level Same Delivery Mode	None
Food Service - Midstream	CK17035	Kitchen Equipment	Commercial Kitchen Equipment		Natural Gas	Midstream	0.81	0.81	0.81	Median of 9 food services program value from literature review	9. Program Level Same Delivery Mode	None
Prescriptive Compressed Air Measures	C80001	General	Compressed Air		Electric	Downstream	0.88	0.88	0.88	Median of 3 values from literature review for retrofit prescriptive programs with compressed air measure offerings	9. Program Level Same Delivery Mode	None
Fat Fryers (Electric)	CK17013	Kitchen Equipment	Cooking Equipment		Electric	Downstream	0.81	0.81	0.81	Median of 9 food services program value from literature review	9. Program Level Same Delivery Mode	None
Griddles (Electric)	CK17014	Kitchen Equipment	Cooking Equipment		Electric	Downstream	0.81	0.81	0.81	Median of 9 food services program value from literature review	9. Program Level Same Delivery Mode	None
Insulated Holding Cabinets	CK17015	Kitchen Equipment	Cooking Equipment		Electric	Downstream	0.81	0.81	0.81	Median of 9 food services program value from literature review	9. Program Level Same Delivery Mode	None
Commercial Fryer (Gas)	CK17016	Kitchen Equipment	Cooking Equipment		Natural Gas	Downstream	0.81	0.81	0.81	Median of 9 food services program value from literature review	9. Program Level Same Delivery Mode	None

Measure	Unique ID #	End Use	Measure Group	PA	Fuel Type	Delivery Mode	NTG 2024	NTG 2025	NTG 2026	NTG Basis	Method	Variation
Commercial Griddle (Gas)	CK17017	Kitchen Equipment	Cooking Equipment		Natural Gas	Downstream	0.81	0.81	0.81	Median of 9 food services program value from literature review	9. Program Level Same Delivery Mode	None
Commercial Rack Oven (Gas)	CK17018	Kitchen Equipment	Cooking Equipment		Natural Gas	Downstream	0.81	0.81	0.81	Median of 9 food services program value from literature review	9. Program Level Same Delivery Mode	None
Compressed Air, Refrigeration, Data Center Equipment/Servers, HVAC/Chillers, HVAC Controls, Motors/VFD - Large, Building Improvements, Process Improvements, Agricultural Lighting/Process, Custom Lighting	C20001	General	Custom		Natural Gas	Downstream	see measure group break outs	see measure group break outs	see measure group break outs			
Compressed Air, Refrigeration, Data Center Equipment/Servers, HVAC/Chillers, HVAC Controls, Motors/VFD - Large, Building Improvements, Process Improvements, Agricultural Lighting/Process, Custom Lighting	C20001	General	Custom		Electric	Downstream	see measure group break outs	see measure group break outs	see measure group break outs			
Custom - Building Improvements	C20001.1	General	Custom		Natural Gas	Downstream	0.82	0.82	0.82	Median of 4 custom gas downstream retrofit program values from literature review	4. Multiple Directly Comparable Sources	None

Measure	Unique ID #	End Use	Measure Group	PA	Fuel Type	Delivery Mode	NTG 2024	NTG 2025	NTG 2026	NTG Basis	Method	Variation
Custom - Water Heating	C20001.2	Waterheating	Custom		Natural Gas	Downstream	0.71	0.71	0.71	Median of 3 downstream custom program values from literature review	5. Similar Measure & Delivery Mode	None
Custom - Water Heating	C20001.2	Waterheating	Custom		Electric	Downstream	0.71	0.71	0.71	Median of 3 downstream custom program values from literature review	5. Similar Measure & Delivery Mode	None
Custom - HVAC	C20001.3	HVAC	Custom		Natural Gas	Downstream	0.82	0.82	0.82	Median of 4 custom gas downstream retrofit program values from literature review	4. Multiple Directly Comparable Sources	None
Custom - HVAC	C20001.3	HVAC	Custom		Electric	Downstream	0.77	0.77	0.77	Median of 9 custom program values from literature review	4. Multiple Directly Comparable Sources	None
Custom - Other	C20001.4	General	Custom		Natural Gas	Downstream	0.82	0.82	0.82	Median of 4 custom gas downstream retrofit program values from literature review	4. Multiple Directly Comparable Sources	None
Custom - Other	C20001.4	General	Custom		Electric	Downstream	0.77	0.77	0.77	Median of 9 custom program values from literature review	4. Multiple Directly Comparable Sources	None
Custom - Lighting	C20001.5	Lighting	Custom		Electric	Downstream	0.53	0.48	0.43	Median of 75 values from literature review	4. Multiple Directly Comparable Sources	f. Annual Decrease (5 percentage points) Due to Rapid Commercialization
Daylight continuous dimming control	CL1029	Lighting	Daylight Controls		Electric	Downstream	0.69	0.66	0.63	Median of 9 lighting system control values from literature review	6. Similar Measure All Delivery Modes	e. Annual Decrease (3 percentage points) Due to Moderate Commercialization

Measure	Unique ID #	End Use	Measure Group	PA	Fuel Type	Delivery Mode	NTG 2024	NTG 2025	NTG 2026	NTG Basis	Method	Variation
Demand Controlled Kitchen Ventilation (DCKV)	CK17034	Kitchen Equipment	Demand Controlled Kitchen Ventilation (DCKV)		Electric	Down-stream	0.81	0.81	0.81	Median of 9 food services program value from literature review	9. Program Level Same Delivery Mode	None
Commercial Modulating Gas Dryer Valve	CNMR-2	Appliances	Dryer Valve		Natural Gas		0.58	0.58	0.58	Median of 6 values from literature	4. Multiple Directly Comparable Sources	None
Dual daylight & occupancy sensor (DOS)	CL1028	Lighting	Dual Daylight/Occupancy Controls		Electric	Down-stream	0.69	0.66	0.63	Median of 9 lighting system control values from literature review	6. Similar Measure All Delivery Modes	e. Annual Decrease (3 percentage points) Due to Moderate Commercialization
Ductless, Mini Split Air Conditioners or Heat Pumps - All Sizes	CV7011	HVAC	Ductless, Mini Split Air Conditioners or Heat Pumps - All Sizes		Electric	Down-stream	0.83	0.80	0.77	Median of 2 HP specific program values from literature review	5. Similar Measure & Delivery Mode	e. Annual Decrease (3 percentage points) Due to Moderate Commercialization
ECM <1 HP	CM16001	Motors	ECM Motors		Electric	Down-stream	0.75	0.75	0.75	Median of 4 values from literature review	9. Program Level Same Delivery Mode	None
ECM 1 HP	CM16002	Motors	ECM Motors		Electric	Down-stream	0.75	0.75	0.75	Median of 4 values from literature review	9. Program Level Same Delivery Mode	None
ECM 2 HP	CM16003	Motors	ECM Motors		Electric	Down-stream	0.75	0.75	0.75	Median of 4 values from literature review	9. Program Level Same Delivery Mode	None
ECM 3-5 HP	CM16004	Motors	ECM Motors		Electric	Down-stream	0.75	0.75	0.75	Median of 4 values from literature review	9. Program Level Same Delivery Mode	None
ECM 6-10 HP	CM16005	Motors	ECM Motors		Electric	Down-stream	0.75	0.75	0.75	Median of 4 values from literature review	9. Program Level Same	None

Measure	Unique ID #	End Use	Measure Group	PA	Fuel Type	Delivery Mode	NTG 2024	NTG 2025	NTG 2026	NTG Basis	Method	Variation
											Delivery Mode	
ECM 11+ HP	CM16006	Motors	ECM Motors		Electric	Downstream	0.75	0.75	0.75	Median of 4 values from literature review	9. Program Level Same Delivery Mode	None
Electric Vehicle Charger	CP5006	Plug Loads	Electric Vehicle Chargers		Electric	Downstream	0.90	0.90	0.90	Evaluator Assigned based on market data	10. Evaluator Assigned	i. Broad Market Trends
Geothermal Heat Pumps – (Ground Source/Ground Water Source)	CV7010	HVAC	Geothermal Heat Pumps - All Sizes		Electric	Downstream	0.83	0.80	0.77	Median of 2 HP specific program values from literature review	5. Similar Measure & Delivery Mode	e. Annual Decrease (3 percentage points) Due to Moderate Commercialization
Glass Door Reach-in Refrigerators	CK17032	Kitchen Equipment	Glass Door Reach-In		Electric	Downstream	0.81	0.81	0.81	Median of 9 food services program value from literature review	9. Program Level Same Delivery Mode	None
Glass Door Reach-in Freezers	CK17033	Kitchen Equipment	Glass Door Reach-In		Electric	Downstream	0.81	0.81	0.81	Median of 9 food services program value from literature review	9. Program Level Same Delivery Mode	None
Hotel Room HVAC Controls	CP5002	Plug Loads	Hotel Room Controls		Electric	Downstream	0.80	0.80	0.80	Median of 2 values from literature review	7. Partial Measure Group	b. 10% Strong Program Impacts Boost; f: Annual Decrease (5 percentage points) Due to Rapid Commercialization; i: Broad Market Trends
Hotel Room HVAC/Receptacle Control	CP5003	Plug Loads	Hotel Room Controls		Electric	Downstream	0.80	0.80	0.80	Median of 2 values from literature review	7. Partial Measure Group	b. 10% Strong Program Impacts Boost; f: Annual Decrease (5 percentage points) Due to Rapid Commercialization; i: Broad Market Trends

Measure	Unique ID #	End Use	Measure Group	PA	Fuel Type	Delivery Mode	NTG 2024	NTG 2025	NTG 2026	NTG Basis	Method	Variation
HVAC - Midstream	CV7063	HVAC	HVAC - Midstream		Electric	Midstream	0.63	0.63	0.63	Median of 5 values from literature review	9. Program Level Same Delivery Mode	None
90% TE Make-up Air Unit	CV7013	HVAC	HVAC - Natural Gas		Natural Gas	Downstream	0.64	0.64	0.64	Median of 2 programs with non-specific gas heating measures values from literature review	6. Similar Measure All Delivery Modes	None
Gas Furnace > 95% AFUE	CV7014	HVAC	HVAC - Natural Gas		Natural Gas	Downstream	0.84	0.84	0.84	Median of 5 values from literature review for programs with boiler related measures	9. Program Level Same Delivery Mode	None
Gas Furnace > 97% AFUE	CV7015	HVAC	HVAC - Natural Gas		Natural Gas	Downstream	0.84	0.84	0.84	Median of 5 values from literature review for programs with boiler related measures	9. Program Level Same Delivery Mode	None
Boiler HW Non-condensing, < 300 MBh (85% AFUE)	CV7016	HVAC	HVAC - Natural Gas		Natural Gas	Downstream	0.84	0.84	0.84	Median of 5 values from literature review for programs with boiler related measures	9. Program Level Same Delivery Mode	None
Boiler HW Non-condensing, 300 to 2,500 MBh (85% TE)	CV7017	HVAC	HVAC - Natural Gas		Natural Gas	Downstream	0.84	0.84	0.84	Median of 5 values from literature review for programs with boiler related measures	9. Program Level Same Delivery Mode	None
Boiler HW Non-condensing, > 2,500 MBh (85% TE)	CV7018	HVAC	HVAC - Natural Gas		Natural Gas	Downstream	0.84	0.84	0.84	Median of 5 values from literature review for programs with boiler related measures	9. Program Level Same Delivery Mode	None
Boiler Tune-up	CV7019	HVAC	HVAC - Natural Gas		Natural Gas	Downstream	0.84	0.84	0.84	Median of 3 values from literature review for programs with boiler tune-up measures	9. Program Level Same Delivery Mode	g. 10% Decrease Due to Common Nature of Measure
Boiler w/Reset Controls	CV7020	HVAC	HVAC - Natural Gas		Natural Gas	Downstream	0.84	0.84	0.84	Median of 5 values from literature review for	9. Program Level Same	None

Measure	Unique ID #	End Use	Measure Group	PA	Fuel Type	Delivery Mode	NTG 2024	NTG 2025	NTG 2026	NTG Basis	Method	Variation
										programs with boiler related measures	Delivery Mode	
Boiler, HW Condensing - Tier 1, < 300 MBh (>90% AFUE)	CV7021	HVAC	HVAC - Natural Gas		Natural Gas	Downstream	0.84	0.84	0.84	Median of 5 values from literature review for programs with boiler related measures	9. Program Level Same Delivery Mode	None
Boiler, HW Condensing - Tier 1, 300 to 2,500 MBh (88%TE)	CV7022	HVAC	HVAC - Natural Gas		Natural Gas	Downstream	0.84	0.84	0.84	Median of 5 values from literature review for programs with boiler related measures	9. Program Level Same Delivery Mode	None
Boiler, HW Condensing - Tier 1, > 2,500 MBh (88% TE)	CV7023	HVAC	HVAC - Natural Gas		Natural Gas	Downstream	0.84	0.84	0.84	Median of 5 values from literature review for programs with boiler related measures	9. Program Level Same Delivery Mode	None
Boiler, HW Condensing - Tier 2, < 300 MBh (>95% AFUE)	CV7024	HVAC	HVAC - Natural Gas		Natural Gas	Downstream	0.84	0.84	0.84	Median of 5 values from literature review for programs with boiler related measures	9. Program Level Same Delivery Mode	None
Boiler, HW Condensing - Tier 2, 300 to 2,500 MBh (>94% TE)	CV7025	HVAC	HVAC - Natural Gas		Natural Gas	Downstream	0.84	0.84	0.84	Median of 5 values from literature review for programs with boiler related measures	9. Program Level Same Delivery Mode	None
Boiler, HW Condensing - Tier 2, > 2,500 MBh (>81%TE)	CV7026	HVAC	HVAC - Natural Gas		Natural Gas	Downstream	0.84	0.84	0.84	Median of 5 values from literature review for programs with boiler related measures	9. Program Level Same Delivery Mode	None
Boiler, Steam < 300 MBH Input (82% AFUE)	CV7027	HVAC	HVAC - Natural Gas		Natural Gas	Downstream	0.84	0.84	0.84	Median of 5 values from literature review for programs with boiler related measures	9. Program Level Same Delivery Mode	None
Boiler, Steam All Except Natural Draft, > 2,500 MBh (81% TE)	CV7028	HVAC	HVAC - Natural Gas		Natural Gas	Downstream	0.84	0.84	0.84	Median of 5 values from literature review for programs with boiler related measures	9. Program Level Same Delivery Mode	None

Measure	Unique ID #	End Use	Measure Group	PA	Fuel Type	Delivery Mode	NTG 2024	NTG 2025	NTG 2026	NTG Basis	Method	Variation
Boiler, Steam All Except Natural Draft, 300 to 2,500 MBh (81% TE)	CV7029	HVAC	HVAC - Natural Gas		Natural Gas	Down-stream	0.84	0.84	0.84	Median of 5 values from literature review for programs with boiler related measures	9. Program Level Same Delivery Mode	None
Boiler, Steam Natural Draft, < 300 to 2,500 MBh (81% TE)	CV7030	HVAC	HVAC - Natural Gas		Natural Gas	Down-stream	0.84	0.84	0.84	Median of 5 values from literature review for programs with boiler related measures	9. Program Level Same Delivery Mode	None
Boiler, Steam Natural Draft, > 2,500 MBh (81% TE)	CV7031	HVAC	HVAC - Natural Gas		Natural Gas	Down-stream	0.84	0.84	0.84	Median of 5 values from literature review for programs with boiler related measures	9. Program Level Same Delivery Mode	None
Condensing Integrated Boiler and Water Heater (<300MBH,90 AFUE)	CV7032	HVAC	HVAC - Natural Gas		Natural Gas	Down-stream	0.84	0.84	0.84	Median of 5 values from literature review for programs with boiler related measures	9. Program Level Same Delivery Mode	None
Condensing Integrated Boiler and Water Heater (>300MBH, 94TE)	CV7033	HVAC	HVAC - Natural Gas		Natural Gas	Down-stream	0.84	0.84	0.84	Median of 5 values from literature review for programs with boiler related measures	9. Program Level Same Delivery Mode	None
Ice Machine, Tier 1	CK17028	Kitchen Equipment	Ice Machines		Electric	Down-stream	0.81	0.81	0.81	Median of 9 food services program value from literature review	9. Program Level Same Delivery Mode	None
Ice Machine, Tier 2	CK17029	Kitchen Equipment	Ice Machines		Electric	Down-stream	0.81	0.81	0.81	Median of 9 food services program value from literature review	9. Program Level Same Delivery Mode	None
New LED display case luminaire, including refrigerator/freezer display	CL1007	Lighting	LED Display Case Luminaires		Electric	Down-stream	0.58	0.53	0.48	Median of 16 linear lamp and fixture values from literature review	7. Partial Measure Group	f. Annual Decrease (5 percentage points) Due to Rapid Commercialization

Measure	Unique ID #	End Use	Measure Group	PA	Fuel Type	Delivery Mode	NTG 2024	NTG 2025	NTG 2026	NTG Basis	Method	Variation
New LED ENERGY STAR LED fixture - meant to replace A-Line, PAR, R, G, MR, and other specialty ¹⁵⁸ type lamps	CL1016.1	Lighting	LED ENERGY STAR Fixtures		Electric	Down-stream	0.00	0.00	0.00	Federal or state standard	3. Federal or State Standard	None
New LED ENERGY STAR LED fixture - meant to replace OTHER THAN A-Line, PAR, R, G, MR, and other specialty type lamps	CL1016.2	Lighting	LED ENERGY STAR Fixtures		Electric	Down-stream	0.53	0.48	0.43	Median of 75 values from literature review	4. Multiple Directly Comparable Sources	f. Annual Decrease (5 percentage points) Due to Rapid Commercialization
New LED luminaire - wall packs, flood lights, canopy, landscape	CL1009	Lighting	LED Exterior Luminaires		Electric	Down-stream	0.64	0.59	0.54	Evaluator assigned relative to the linear value of 63%	10. Evaluator Assigned	b. 10% Strong Program Impacts Boost; f: Annual Decrease (5 percentage points) Due to Rapid Commercialization; i: Broad Market Trends
New LED flat panel for 2x2, 1x4 and 2x4 luminaires	CL1002	Lighting	LED Flat Panel Luminaires		Electric	Down-stream	0.58	0.53	0.48	Median of 16 linear lamp and fixture values from literature review	7. Partial Measure Group	f. Annual Decrease (5 percentage points) Due to Rapid Commercialization
New LED high/low bay luminaire	CL1008	Lighting	LED High/Low Bay Luminaires		Electric	Down-stream	0.64	0.59	0.54	Evaluator assigned relative to the linear value of 63%	10. Evaluator Assigned	b. 10% Strong Program Impacts Boost; f: Annual Decrease (5 percentage points) Due to Rapid Commercialization; i: Broad Market Trends
New LED wall wash luminaire	CL1005	Lighting	LED Interior Directional Luminaires		Electric	Down-stream	0.58	0.53	0.48	Median of 16 linear lamp and fixture values from literature review	7. Partial Measure Group	f. Annual Decrease (5 percentage points)

¹⁵⁸ NTG Source: <https://njcleanenergy.com/files/file/Library/FY23/NJ%20Residential%20Lighting%20Sales%20and%20NTG%20Analysis%2020220707.pdf>

Measure	Unique ID #	End Use	Measure Group	PA	Fuel Type	Delivery Mode	NTG 2024	NTG 2025	NTG 2026	NTG Basis	Method	Variation
												Due to Rapid Commercialization
New LED track/mono-point luminaire ¹⁵⁹	CL1006	Lighting	LED Interior Directional Luminaires		Electric	Down-stream	0.00	0.00	0.00	Federal or state standard	3. Federal or State Standard	None
New LED linear ambient luminaire	CL1003	Lighting	LED Linear Ambient/Stairwell Luminaires		Electric	Down-stream	0.58	0.53	0.48	Median of 16 linear lamp and fixture values from literature review	7. Partial Measure Group	f. Annual Decrease (5 percentage points) Due to Rapid Commercialization
New LED stairwell luminaire	CL1004	Lighting	LED Linear Ambient/Stairwell Luminaires		Electric	Down-stream	0.58	0.53	0.48	Median of 16 linear lamp and fixture values from literature review	7. Partial Measure Group	f. Annual Decrease (5 percentage points) Due to Rapid Commercialization
LED linear replacement lamp with new LED driver for wall pack, flood light, canopy, recessed fixture.	CL1017	Lighting	LED Replacement Lamps		Electric	Down-stream	0.58	0.53	0.48	Median of 16 linear lamp and fixture values from literature review	7. Partial Measure Group	f. Annual Decrease (5 percentage points) Due to Rapid Commercialization
LED mogul-screw base replacement for HID lamps and new external driver	CL1018	Lighting	LED Replacement Lamps		Electric	Down-stream	0.64	0.59	0.54	Evaluator assigned relative to the linear value of 63%	10. Evaluator Assigned	b. 10% Strong Program Impacts Boost; f: Annual Decrease (5 percentage points) Due to Rapid Commercialization; i: Broad Market Trends
LED lamps - A-Line, PAR, R, G, MR, and other specialty type lamps ¹⁶⁰	CL1019	Lighting	LED Replacement Lamps		Electric	Down-stream	0.00	0.00	0.00	Federal or state standard	3. Federal or State Standard	None

¹⁵⁹ NTG Source: <https://njcleanenergy.com/files/file/Library/FY23/NJ%20Residential%20Lighting%20Sales%20and%20NTG%20Analysis%2020220707.pdf>

¹⁶⁰ NTG Source: <https://njcleanenergy.com/files/file/Library/FY23/NJ%20Residential%20Lighting%20Sales%20and%20NTG%20Analysis%2020220707.pdf>

Measure	Unique ID #	End Use	Measure Group	PA	Fuel Type	Delivery Mode	NTG 2024	NTG 2025	NTG 2026	NTG Basis	Method	Variation
LED Replacement Lamps 2' - 8' (Type A, B 7 AB)	CL1020	Lighting	LED Replacement Lamps		Electric	Down-stream	0.58	0.53	0.48	Median of 16 linear lamp and fixture values from literature review	7. Partial Measure Group	f. Annual Decrease (5 percentage points) Due to Rapid Commercialization
LED linear retrofit kit for 2x2, 1x4 and 2x4 fixtures	CL1010	Lighting	LED Retrofit Kits		Electric	Down-stream	0.58	0.53	0.48	Median of 16 linear lamp and fixture values from literature review	7. Partial Measure Group	f. Annual Decrease (5 percentage points) Due to Rapid Commercialization
LED integrated retrofit kit for 2x2, 1x4 and 2x4 fixtures	CL1011	Lighting	LED Retrofit Kits		Electric	Down-stream	0.58	0.53	0.48	Median of 16 linear lamp and fixture values from literature review	7. Partial Measure Group	f. Annual Decrease (5 percentage points) Due to Rapid Commercialization
LED retrofit kit for linear ambient luminaire	CL1012	Lighting	LED Retrofit Kits		Electric	Down-stream	0.58	0.53	0.48	Median of 16 linear lamp and fixture values from literature review	7. Partial Measure Group	f. Annual Decrease (5 percentage points) Due to Rapid Commercialization
LED retrofit kit for high/low bay luminaires	CL1013	Lighting	LED Retrofit Kits		Electric	Down-stream	0.64	0.59	0.54	Evaluator assigned relative to the linear value of 63%	10. Evaluator Assigned	b. 10% Strong Program Impacts Boost; f: Annual Decrease (5 percentage points) Due to Rapid Commercialization; i: Broad Market Trends
LED retrofit kit for exterior luminaire	CL1014	Lighting	LED Retrofit Kits		Electric	Down-stream	0.64	0.59	0.54	Evaluator assigned relative to the linear value of 63%	10. Evaluator Assigned	b. 10% Strong Program Impacts Boost; f: Annual Decrease (5 percentage points) Due to Rapid Commercialization; i: Broad Market Trends

Measure	Unique ID #	End Use	Measure Group	PA	Fuel Type	Delivery Mode	NTG 2024	NTG 2025	NTG 2026	NTG Basis	Method	Variation
LED retrofit kit for recessed downlight ¹⁶¹	CL1015	Lighting	LED Retrofit Kits		Electric	Down-stream	0.00	0.00	0.00	Federal or state standard	3. Federal or State Standard	None
Exterior/Dusk-to-Dawn, Interior and 24 hour application	CL1021	Lighting	LED Sign Lighting		Electric	Down-stream	0.64	0.59	0.54	Evaluator assigned relative to the linear value of 63%	10. Evaluator Assigned	b. 10% Strong Program Impacts Boost; f: Annual Decrease (5 percentage points) Due to Rapid Commercialization; i: Broad Market Trends
New LED linear recessed troffer/panel for 2x2, 1x4 and 2x4 luminaires	CL1001	Lighting	LED Troffer Luminaires		Electric	Down-stream	0.58	0.53	0.48	Median of 16 linear lamp and fixture values from literature review	7. Partial Measure Group	f. Annual Decrease (5 percentage points) Due to Rapid Commercialization
Multifamily - Unless otherwise specified			Multifamily Common Areas				See Method	See Method	See Method	Apply Residential NTG Ratios to In-Unit Measures and Commercial NTG Ratios to Common Area Measures		
Networked lighting control system controlling efficient luminaires	CL1026	Lighting	Networked Lighting Controls		Electric	Down-stream	0.69	0.66	0.63	Median of 9 lighting system control values from literature review	6. Similar Measure All Delivery Modes	e. Annual Decrease (3 percentage points) Due to Moderate Commercialization
Networked lighting control - fixture level control	CL1027	Lighting	Networked Lighting Controls		Electric	Down-stream	0.69	0.66	0.63	Median of 9 lighting system control values from literature review	6. Similar Measure All Delivery Modes	e. Annual Decrease (3 percentage points) Due to Moderate Commercialization
Personal Occupancy Sensor	CP5001	Plug Loads	Occupancy Sensor		Electric	Down-stream	0.80	0.80	0.80	Median of 35 downstream prescriptive program values from literature review	9. Program Level Same Delivery Mode	None

¹⁶¹ NTG Source: <https://njcleanenergy.com/files/file/Library/FY23/NJ%20Residential%20Lighting%20Sales%20and%20NTG%20Analysis%2020220707.pdf>

Measure	Unique ID #	End Use	Measure Group	PA	Fuel Type	Delivery Mode	NTG 2024	NTG 2025	NTG 2026	NTG Basis	Method	Variation
Vacancy or Occupancy control (Switch/Wall/External Mount)	CL1030	Lighting	Occupancy/Vacancy Controls		Electric	Down-stream	0.62	0.59	0.56	Median of 9 fixture based control system values from literature review	6. Similar Measure All Delivery Modes	e. Annual Decrease (3 percentage points) Due to Moderate Commercialization
Vacancy or Occupancy control (Integrated)	CL1031	Lighting	Occupancy/Vacancy Controls		Electric	Down-stream	0.69	0.66	0.63	Median of 9 lighting system control values from literature review	6. Similar Measure All Delivery Modes	e. Annual Decrease (3 percentage points) Due to Moderate Commercialization
Monitors - C&I	CO4001	Office	Office Equipment		Electric	Down-stream	0.27	0.24	0.21	Evaluator Assigned based on market data	10. Evaluator Assigned	h. National Shipment Data
Computers - C&I	CO4002	Office	Office Equipment		Electric	Down-stream	0.27	0.24	0.21	Evaluator Assigned based on market data	10. Evaluator Assigned	h. National Shipment Data
Uninterruptible Power Supply (UPS)	CO4003	Office	Office Equipment		Electric	Down-stream	0.27	0.24	0.21	Evaluator Assigned based on market data	10. Evaluator Assigned	h. National Shipment Data
Imaging - C&I	CO4004	Office	Office Equipment		Electric	Down-stream	0.27	0.24	0.21	Evaluator Assigned based on market data	10. Evaluator Assigned	h. National Shipment Data
Small Network PC Controller	CO4005	Office	Office Equipment		Electric	Down-stream	0.27	0.24	0.21	Evaluator Assigned based on market data	10. Evaluator Assigned	h. National Shipment Data
Energy Star Beverage Vending Machine	CK17025	Kitchen Equipment	Other Food Service		Electric	Down-stream	0.81	0.81	0.81	Median of 9 food services program value from literature review	9. Program Level Same Delivery Mode	None
Food Warmers/Rethernalizer Well/Coffee Pots	CK17026	Kitchen Equipment	Other Food Service		Electric	Down-stream	0.81	0.81	0.81	Median of 9 food services program value from literature review	9. Program Level Same Delivery Mode	None

Measure	Unique ID #	End Use	Measure Group	PA	Fuel Type	Delivery Mode	NTG 2024	NTG 2025	NTG 2026	NTG Basis	Method	Variation
Pre-Rinse Spray Valve	CK17027	Kitchen Equipment	Other Food Service		Electric	Down-stream	0.81	0.81	0.81	Median of 9 food services program value from literature review	9. Program Level Same Delivery Mode	None
Pre-Rinse Spray Valve	CK17027	Kitchen Equipment	Other Food Service		Natural Gas	Down-stream	0.81	0.81	0.81	Median of 9 food services program value from literature review	9. Program Level Same Delivery Mode	None
Thermostat - Smart	CV7035	HVAC	Other HVAC Equipment		Electric	Down-stream	0.82	0.79	0.76	Median of 3 values from literature review for programs with non-specific cooling measures	9. Program Level Same Delivery Mode	e. Annual Decrease (3 percentage points) Due to Moderate Commercialization
Thermostat - Smart	CV7035	HVAC	Other HVAC Equipment		Natural Gas	Down-stream	0.80	0.77	0.74	Median of 3 values from literature review for programs with HVAC controls measures	9. Program Level Same Delivery Mode	g. 10% Decrease Due to Common Nature of Measure; e. Annual Decrease (3 percentage points) Due to Moderate Commercialization
Dual Enthalpy Economizer Controls, unspecified	CV7036	HVAC	Other HVAC Equipment		Electric	Down-stream	0.86	0.86	0.86	Median of 2 values from literature review	5. Similar Measure & Delivery Mode	None
Dual Enthalpy Economizer Controls, < 5 tons	CV7037	HVAC	Other HVAC Equipment		Electric	Down-stream	0.86	0.86	0.86	Median of 2 values from literature review	5. Similar Measure & Delivery Mode	None
Dual Enthalpy Economizer Controls, > 5 tons	CV7038	HVAC	Other HVAC Equipment		Electric	Down-stream	0.86	0.86	0.86	Median of 2 values from literature review	5. Similar Measure & Delivery Mode	None
Demand Control Ventilation	CV7039	HVAC	Other HVAC Equipment		Electric	Down-stream	0.86	0.86	0.86	Median of 2 values from literature review	5. Similar Measure &	None

Measure	Unique ID #	End Use	Measure Group	PA	Fuel Type	Delivery Mode	NTG 2024	NTG 2025	NTG 2026	NTG Basis	Method	Variation
											Delivery Mode	
Boiler Economizer Controls, < 800,000 Btu	CV7040	HVAC	Other HVAC Equipment - Natural Gas		Natural Gas	Downstream	0.84	0.84	0.84	Median of 5 values from literature review for programs with boiler related measures	9. Program Level Same Delivery Mode	None
Boiler Economizer Controls, > 4 MMBtu	CV7041	HVAC	Other HVAC Equipment - Natural Gas		Natural Gas	Downstream	0.84	0.84	0.84	Median of 5 values from literature review for programs with boiler related measures	9. Program Level Same Delivery Mode	None
Boiler Economizer Controls, 0.8 to 1.6 MMBtu	CV7042	HVAC	Other HVAC Equipment - Natural Gas		Natural Gas	Downstream	0.84	0.84	0.84	Median of 5 values from literature review for programs with boiler related measures	9. Program Level Same Delivery Mode	None
Boiler Economizer Controls, 1.6 to 3 MMBtu	CV7043	HVAC	Other HVAC Equipment - Natural Gas		Natural Gas	Downstream	0.84	0.84	0.84	Median of 5 values from literature review for programs with boiler related measures	9. Program Level Same Delivery Mode	None
Boiler Economizer Controls, 3 to 3.5 MMBtu	CV7044	HVAC	Other HVAC Equipment - Natural Gas		Natural Gas	Downstream	0.84	0.84	0.84	Median of 5 values from literature review for programs with boiler related measures	9. Program Level Same Delivery Mode	None
Boiler Economizer Controls, 3.5 to 4 MMBtu	CV7045	HVAC	Other HVAC Equipment - Natural Gas		Natural Gas	Downstream	0.84	0.84	0.84	Median of 5 values from literature review for programs with boiler related measures	9. Program Level Same Delivery Mode	None
HW Recirculating System with demand control	CV7046	HVAC	Other HVAC Equipment - Natural Gas		Natural Gas	Downstream	0.84	0.84	0.84	Median of 5 values from literature review for programs with boiler related measures	9. Program Level Same Delivery Mode	None
Ventilation with Heat Recovery Gas HRV	CV7047	HVAC	Other HVAC Equipment - Natural Gas		Natural Gas	Downstream	0.64	0.64	0.64	Median of 2 programs with non-specific gas heating measures values from literature review	6. Similar Measure All Delivery Modes	None

Measure	Unique ID #	End Use	Measure Group	PA	Fuel Type	Delivery Mode	NTG 2024	NTG 2025	NTG 2026	NTG Basis	Method	Variation
Ventilation with Heat Recovery Gas ERV	CV7048	HVAC	Other HVAC Equipment - Natural Gas		Natural Gas	Downstream	0.64	0.64	0.64	Median of 2 programs with non-specific gas heating measures values from literature review	6. Similar Measure All Delivery Modes	None
Boiler Tune-up	CV7049	HVAC	Other HVAC Equipment - Natural Gas		Natural Gas	Downstream	0.84	0.84	0.84	Median of 3 values from literature review for programs with boiler tune-up measures	9. Program Level Same Delivery Mode	g. 10% Decrease Due to Common Nature of Measure
Furnace Tune-up	CV7050	HVAC	Other HVAC Equipment - Natural Gas		Natural Gas	Downstream	0.84	0.84	0.84	Median of 3 values from literature review for programs with boiler tune-up measures	9. Program Level Same Delivery Mode	g. 10% Decrease Due to Common Nature of Measure
Exit Signs	CL1022	Lighting	Other Lighting		Electric	Downstream	0.53	0.48	0.43	Median of 75 values from literature review	4. Multiple Directly Comparable Sources	f. Annual Decrease (5 percentage points) Due to Rapid Commercialization
Linear Fluorescent HE T8	CL1023	Lighting	Other Lighting		Electric	Downstream	0.58	0.53	0.48	Median of 16 linear lamp and fixture values from literature review	7. Partial Measure Group	f. Annual Decrease (5 percentage points) Due to Rapid Commercialization
Street/Roadway and Area Lighting	CL1024	Lighting	Other Lighting		Electric	Downstream	0.75	0.75	0.75	Median of 2 values in literature review	8. Full Measure Group	None
Horticultural Lighting (Controlled Environment Agriculture)	CL1025	Lighting	Other Lighting		Electric	Downstream	0.53	0.48	0.43	Median of 75 values from literature review	4. Multiple Directly Comparable Sources	f. Annual Decrease (5 percentage points) Due to Rapid Commercialization
Delamping	CL1032	Lighting	Other Lighting		Electric	Downstream	0.53	0.48	0.43	Median of 75 values from literature review	4. Multiple Directly Comparable Sources	f. Annual Decrease (5 percentage points) Due to Rapid Commercialization
Lighting - Midstream Linear Types (TLEDs,	CL1033.1	Lighting	Other Lighting		Electric	Midstream	0.58	0.53	0.48	Median of 16 linear lamp and fixture values from literature review	7. Partial Measure Group	f. Annual Decrease (5 percentage points)

Measure	Unique ID #	End Use	Measure Group	PA	Fuel Type	Delivery Mode	NTG 2024	NTG 2025	NTG 2026	NTG Basis	Method	Variation
luminaires meant to replace linears)												Due to Rapid Commercialization
Lighting - Midstream LED Lamps A-Line, PAR, R, G, MR, and other specialty type lamps ¹⁶²	CL1033.2	Lighting	Other Lighting		Electric	Midstream	0.00	0.00	0.00	Federal or state standard	3. Federal or State Standard	None
Lighting - Midstream High/Low Bay	CL1033.3	Lighting	Other Lighting		Electric	Midstream	0.64	0.59	0.54	Evaluator assigned relative to the linear value of 63%	10. Evaluator Assigned	b. 10% Strong Program Impacts Boost; f: Annual Decrease (5 percentage points) Due to Rapid Commercialization; i: Broad Market Trends
Lighting - Midstream Exterior	CL1033.4	Lighting	Other Lighting		Electric	Midstream	0.64	0.59	0.54	Evaluator assigned relative to the linear value of 63%	10. Evaluator Assigned	b. 10% Strong Program Impacts Boost; f: Annual Decrease (5 percentage points) Due to Rapid Commercialization; i: Broad Market Trends
Lighting - Midstream networked lighting controls system	CL1033.5	Lighting	Other Lighting		Electric	Midstream	0.69	0.66	0.63	Median of 9 lighting system control values from literature review	6. Similar Measure All Delivery Modes	e. Annual Decrease (3 percentage points) Due to Moderate Commercialization
Lighting - Midstream Networked lighting controls fixture level	CL1033.6	Lighting	Other Lighting		Electric	Midstream	0.69	0.66	0.63	Median of 9 fixture based control system values from literature review	6. Similar Measure All Delivery Modes	e. Annual Decrease (3 percentage points) Due to Moderate Commercialization
Packaged Terminal Air Conditioners or Heat Pumps - All Sizes	CV7012	HVAC	Packaged Terminal Air Conditioners or Heat Pumps - All Sizes		Electric	Down-stream	0.83	0.80	0.77	Median of 2 HP specific program values from literature review	5. Similar Measure & Delivery Mode	e. Annual Decrease (3 percentage points) Due to Moderate Commercialization

¹⁶² NTG Source: <https://njcleanenergy.com/files/file/Library/FY23/NJ%20Residential%20Lighting%20Sales%20and%20NTG%20Analysis%2020220707.pdf>

Measure	Unique ID #	End Use	Measure Group	PA	Fuel Type	Delivery Mode	NTG 2024	NTG 2025	NTG 2026	NTG Basis	Method	Variation
Smart Power Strip - Tier 1	CP5004	Plug Loads	Power Strip		Electric	Down-stream	0.90	0.90	0.90	Evaluator Assigned based on market data	10. Evaluator Assigned	i. Broad Market Trends
Smart Power Strip - Tier 2	CP5005	Plug Loads	Power Strip		Electric	Down-stream	0.90	0.90	0.90	Evaluator Assigned based on market data	10. Evaluator Assigned	i. Broad Market Trends
Refrigerator Recycling	CE6001	Early Retirement / Recycling	Recycling		Electric	Down-stream	0.51	0.51	0.51	Median of 19 values from literature	5. Similar Measure & Delivery Mode	None
Freezer Recycling	CE6002	Early Retirement / Recycling	Recycling		Electric	Down-stream	0.58	0.58	0.58	Median of 14 values from literature	6. Similar Measure All Delivery Modes	None
Room A/C Unit Recycling	CE6003	Early Retirement / Recycling	Recycling		Electric	Down-stream	0.50	0.50	0.50	Median of 6 values from literature	5. Similar Measure & Delivery Mode	None
Dehumidifier Recycling	CE6004	Early Retirement / Recycling	Recycling		Electric	Down-stream	0.41	0.41	0.41	Median of 7 values from literature	5. Similar Measure & Delivery Mode	None
Anti-Fog Film	CR14001	Refrigeration	Refrigeration		Electric	Down-stream	0.93	0.93	0.93	Median of 2 values from literature review	4. Multiple Directly Comparable Sources	None
Anti-Sweat Heat Control	CR14002	Refrigeration	Refrigeration		Electric	Down-stream	0.93	0.93	0.93	Median of 2 values from literature review	4. Multiple Directly Comparable Sources	None
ECM Evaporator Fan Motor, <1 hp	CR14003	Refrigeration	Refrigeration		Electric	Down-stream	0.75	0.75	0.75	Median of 4 values from literature review	9. Program Level Same Delivery Mode	None

Measure	Unique ID #	End Use	Measure Group	PA	Fuel Type	Delivery Mode	NTG 2024	NTG 2025	NTG 2026	NTG Basis	Method	Variation
Evaporator/Compressor Controller	CR14004	Refrigeration	Refrigeration		Electric	Down-stream	0.93	0.93	0.93	Median of 2 values from literature review	4. Multiple Directly Comparable Sources	None
Evaporator Fan Controller on Existing Shaded-Pole Motor	CR14005	Refrigeration	Refrigeration		Electric	Down-stream	0.75	0.75	0.75	Median of 4 values from literature review	9. Program Level Same Delivery Mode	None
Night Covers - Open Reach-In Coolers	CR14006	Refrigeration	Refrigeration		Electric	Down-stream	0.93	0.93	0.93	Median of 2 values from literature review	4. Multiple Directly Comparable Sources	None
Reach-In Door Closer	CR14007	Refrigeration	Refrigeration		Electric	Down-stream	0.93	0.93	0.93	Median of 2 values from literature review	4. Multiple Directly Comparable Sources	None
Refrigeration Display Case Doors on Open Display Case	CR14008	Refrigeration	Refrigeration		Electric	Down-stream	0.93	0.93	0.93	Median of 2 values from literature review	4. Multiple Directly Comparable Sources	None
Gaskets	CR14009	Refrigeration	Refrigeration		Electric	Down-stream	0.93	0.93	0.93	Median of 2 values from literature review	4. Multiple Directly Comparable Sources	None
Strip Curtains for Walk-In Coolers and Freezers	CR14010	Refrigeration	Refrigeration		Electric	Down-stream	0.93	0.93	0.93	Median of 2 values from literature review	4. Multiple Directly Comparable Sources	None
Refrigerator Case Light Sensor	CR14011	Refrigeration	Refrigeration		Electric	Down-stream	0.93	0.93	0.93	Median of 2 values from literature review	4. Multiple Directly Comparable Sources	None
Floating Head Pressure Controls	CR14012	Refrigeration	Refrigeration		Electric	Down-stream	0.93	0.93	0.93	Median of 2 values from literature review	4. Multiple Directly	None

Measure	Unique ID #	End Use	Measure Group	PA	Fuel Type	Delivery Mode	NTG 2024	NTG 2025	NTG 2026	NTG Basis	Method	Variation
											Comparable Sources	
Variable Speed Refrigeration Compressor	CR14013	Refrigeration	Refrigeration		Electric	Downstream	0.93	0.93	0.93	Median of 2 values from literature review	4. Multiple Directly Comparable Sources	None
Clothes Washer Tier 1	CA2003	Appliances	Residential Appliances in C&I Building - Non Commercial Duty		Natural Gas	Downstream	0.51	0.51	0.51	Median of 3 values from literature	4. Multiple Directly Comparable Sources	a. Removed Outliers
Clothes Washer Tier 2	CA2004	Appliances	Residential Appliances in C&I Building - Non Commercial Duty		Natural Gas	Downstream	0.51	0.51	0.51	Median of 3 values from literature	4. Multiple Directly Comparable Sources	a. Removed Outliers
Clothes Dryer - Tier 1	CA2005	Appliances	Residential Appliances in C&I Building - Non Commercial Duty		Electric	Downstream	0.58	0.58	0.58	Median of 6 values from literature	4. Multiple Directly Comparable Sources	None
Clothes Dryer - Tier 1	CA2005	Appliances	Residential Appliances in C&I Building - Non Commercial Duty		Natural Gas	Downstream	0.58	0.58	0.58	Median of 6 values from literature	4. Multiple Directly Comparable Sources	None
Clothes Dryer - Tier 2	CA2006	Appliances	Residential Appliances in C&I Building - Non Commercial Duty		Electric	Downstream	0.58	0.58	0.58	Median of 6 values from literature	4. Multiple Directly Comparable Sources	None
Clothes Dryer - Tier 2	CA2006	Appliances	Residential Appliances in C&I Building - Non Commercial Duty		Natural Gas	Downstream	0.58	0.58	0.58	Median of 6 values from literature	4. Multiple Directly Comparable Sources	None
Refrigerators Tier 1	CA2007	Appliances	Residential Appliances in C&I Building - Non Commercial Duty		Electric	Downstream	0.47	0.47	0.47	Median of 6 values from literature	4. Multiple Directly Comparable Sources	a. Removed Outliers

Measure	Unique ID #	End Use	Measure Group	PA	Fuel Type	Delivery Mode	NTG 2024	NTG 2025	NTG 2026	NTG Basis	Method	Variation
Refrigerators Tier 2	CA2008	Appliances	Residential Appliances in C&I Building - Non Commercial Duty		Electric	Down-stream	0.47	0.47	0.47	Median of 6 values from literature	4. Multiple Directly Comparable Sources	a. Removed Outliers
Freezer	CA2009	Appliances	Residential Appliances in C&I Building - Non Commercial Duty		Electric	Down-stream	0.52	0.52	0.52	Median of 26 kitchen and laundry appliance values in literature	7. Partial Measure Group	a. Removed Outliers
Dehumidifier	CA2010	Appliances	Residential Appliances in C&I Building - Non Commercial Duty		Electric	Down-stream	0.49	0.49	0.49	Median of 12 values from literature	4. Multiple Directly Comparable Sources	None
Room Air Conditioner	CA2011	Appliances	Residential Appliances in C&I Building - Non Commercial Duty		Electric	Down-stream	0.54	0.54	0.54	Median of 9 values from literature	4. Multiple Directly Comparable Sources	None
Water Cooler	CA2012	Appliances	Residential Appliances in C&I Building - Non Commercial Duty		Electric	Down-stream	0.52	0.52	0.52	Median of 26 kitchen and laundry appliance values in literature	7. Partial Measure Group	a. Removed Outliers
Indoor Pool Cover	CNMR-5	Appliances	Residential Appliances in C&I Building - Non Commercial Duty	PSE&G	Natural Gas		0.80	0.80	0.80	Median of 35 downstream prescriptive program values from literature review	9. Program Level Same Delivery Mode	None
Outdoor Pool Cover	CNMR-6	Appliances	Residential Appliances in C&I Building - Non Commercial Duty	PSE&G	Natural Gas		0.80	0.80	0.80	Median of 35 downstream prescriptive program values from literature review	9. Program Level Same Delivery Mode	None
Retrocommissioning Single compressor units	C40001	General	Retrocommissioning (including Virtual and Meter Data Commissioning)		Electric	Down-stream	0.75	0.75	0.75	Median of 3 electric RCx program values from literature review	9. Program Level Same Delivery Mode	None

Measure	Unique ID #	End Use	Measure Group	PA	Fuel Type	Delivery Mode	NTG 2024	NTG 2025	NTG 2026	NTG Basis	Method	Variation
Retrocommissioning Multiple compressor units	C40002	General	Retrocommissioning (including Virtual and Meter Data Commissioning)		Electric	Down-stream	0.75	0.75	0.75	Median of 3 electric RCx program values from literature review	9. Program Level Same Delivery Mode	None
Retrocommissioning PTAC, PTHP, MiniSplits	C40003	General	Retrocommissioning (including Virtual and Meter Data Commissioning)		Electric	Down-stream	0.75	0.75	0.75	Median of 3 electric RCx program values from literature review	9. Program Level Same Delivery Mode	None
Retrocommissioning (including Virtual and Meter Data Commissioning)	C40004	General	Retrocommissioning (including Virtual and Meter Data Commissioning)		Electric	Down-stream	0.75	0.75	0.75	Median of 3 electric RCx program values from literature review	9. Program Level Same Delivery Mode	None
Retrocommissioning (including Virtual and Meter Data Commissioning)	C30001	General	Retrocommissioning (including Virtual and Meter Data Commissioning), Custom		Natural Gas	Down-stream	0.96	0.96	0.96	Median of 2 RCx gas program values from literature review	9. Program Level Same Delivery Mode	None
Retrocommissioning (including Virtual and Meter Data Commissioning)	C30001	General	Retrocommissioning (including Virtual and Meter Data Commissioning), Custom		Electric	Down-stream	0.75	0.75	0.75	Median of 3 electric RCx program values from literature review	9. Program Level Same Delivery Mode	None
SBDI - Unitary HVAC/Split Systems and Single Package, Air Cooled	CSBDI1001	HVAC	SBDI Measures		Electric	Direct Install	0.91	0.91	0.91	Median of 9 values from literature review	9. Program Level Same Delivery Mode	None
SBDI - Air-Air Cooled Heat Pump Systems, Split System and Single Package	CSBDI1002	HVAC	SBDI Measures		Electric	Direct Install	0.88	0.85	0.82	Median of 9 values from literature review	9. Program Level Same Delivery Mode	e. Annual Decrease (3 percentage points) Due to Moderate Commercialization
SBDI - Water Source Heat Pumps	CSBDI1003	HVAC	SBDI Measures		Electric	Direct Install	0.88	0.85	0.82	Median of 9 values from literature review	9. Program Level Same Delivery Mode	e. Annual Decrease (3 percentage points) Due to Moderate Commercialization

Measure	Unique ID #	End Use	Measure Group	PA	Fuel Type	Delivery Mode	NTG 2024	NTG 2025	NTG 2026	NTG Basis	Method	Variation
SBDI - Furnace High Efficiency Fan	CSBDI1004	HVAC	SBDI Measures		Electric	Direct Install	0.91	0.91	0.91	Median of 9 values from literature review	9. Program Level Same Delivery Mode	None
SBDI - Solar Domestic Hot Water (augmenting electric resistance DHW)	CSBDI1005	Waterheating	SBDI Measures		Electric	Direct Install	0.91	0.91	0.91	Median of 9 values from literature review	9. Program Level Same Delivery Mode	None
SBDI - Heat Pump Hot Water (HPHW)	CSBDI1006	Waterheating	SBDI Measures		Electric	Direct Install	0.88	0.85	0.82	Median of 9 values from literature review	9. Program Level Same Delivery Mode	e. Annual Decrease (3 percentage points) Due to Moderate Commercialization
SBDI - Drain Water Heat Recovery (DWHR)	CSBDI1007	Waterheating	SBDI Measures		Electric	Direct Install	0.91	0.91	0.91	Median of 9 values from literature review	9. Program Level Same Delivery Mode	None
SBDI - Motors	CSBDI1008	Motors	SBDI Measures		Electric	Direct Install	0.91	0.91	0.91	Median of 9 values from literature review	9. Program Level Same Delivery Mode	None
SBDI - Variable Frequency Drives	CSBDI1009	VFD / Drives	SBDI Measures		Electric	Direct Install	0.91	0.91	0.91	Median of 9 values from literature review	9. Program Level Same Delivery Mode	None
SBDI - Walk-in Cooler/Freezer Evaporator Fan Control	CSBDI1010	Refrigeration	SBDI Measures		Electric	Direct Install	0.91	0.91	0.91	Median of 9 values from literature review	9. Program Level Same Delivery Mode	None
SBDI - Cooler and Freezer Door Heater Control	CSBDI1011	Refrigeration	SBDI Measures		Electric	Direct Install	0.91	0.91	0.91	Median of 9 values from literature review	9. Program Level Same Delivery Mode	None
SBDI - Electric Defrost Control	CSBDI1012	Refrigeration	SBDI Measures		Electric	Direct Install	0.91	0.91	0.91	Median of 9 values from literature review	9. Program Level Same	None

Measure	Unique ID #	End Use	Measure Group	PA	Fuel Type	Delivery Mode	NTG 2024	NTG 2025	NTG 2026	NTG Basis	Method	Variation
											Delivery Mode	
SBDI - Aluminum Night Covers	CSBDI1013	Refrigeration	SBDI Measures		Electric	Direct Install	0.91	0.91	0.91	Median of 9 values from literature review	9. Program Level Same Delivery Mode	None
SBDI - Novelty Cooler Shutoff	CSBDI1014	Refrigeration	SBDI Measures		Electric	Direct Install	0.91	0.91	0.91	Median of 9 values from literature review	9. Program Level Same Delivery Mode	None
SBDI - Energy Efficient Glass Doors on Open Refrigerated Cases	CSBDI1015	Refrigeration	SBDI Measures		Electric	Direct Install	0.91	0.91	0.91	Median of 9 values from literature review	9. Program Level Same Delivery Mode	None
SBDI - ECM on Evaporator Fans	CSBDI1016	Refrigeration	SBDI Measures		Electric	Direct Install	0.91	0.91	0.91	Median of 9 values from literature review	9. Program Level Same Delivery Mode	None
SBDI - Refrigerated Vending Machine Control	CSBDI1017	Kitchen Equipment	SBDI Measures		Electric	Direct Install	0.91	0.91	0.91	Median of 9 values from literature review	9. Program Level Same Delivery Mode	None
SBDI - Refrigerated Case LED Lighting (Prescriptive Lighting)	CSBDI1018	Kitchen Equipment	SBDI Measures		Electric	Direct Install	0.91	0.91	0.91	Median of 9 values from literature review	9. Program Level Same Delivery Mode	None
SBDI - Vending Machine Controls	CSBDI1019	Kitchen Equipment	SBDI Measures		Electric	Direct Install	0.91	0.91	0.91	Median of 9 values from literature review	9. Program Level Same Delivery Mode	None
SBDI - Stand Alone Storage Water Heaters	CSBDI1020	Waterheating	SBDI Measures		Natural Gas	Direct Install	0.91	0.91	0.91	Median of 9 values from literature review	9. Program Level Same Delivery Mode	None

Measure	Unique ID #	End Use	Measure Group	PA	Fuel Type	Delivery Mode	NTG 2024	NTG 2025	NTG 2026	NTG Basis	Method	Variation
SBDI - Instantaneous Water Heaters	CSBDI1021	Waterheating	SBDI Measures		Natural Gas	Direct Install	0.91	0.91	0.91	Median of 9 values from literature review	9. Program Level Same Delivery Mode	None
SBDI - Boilers	CSBDI1022	HVAC	SBDI Measures		Natural Gas	Direct Install	0.91	0.91	0.91	Median of 9 values from literature review	9. Program Level Same Delivery Mode	None
SBDI - Small Commercial Boilers	CSBDI1023	HVAC	SBDI Measures		Natural Gas	Direct Install	0.91	0.91	0.91	Median of 9 values from literature review	9. Program Level Same Delivery Mode	None
SBDI - Gas Furnaces	CSBDI1024	HVAC	SBDI Measures		Natural Gas	Direct Install	0.91	0.91	0.91	Median of 9 values from literature review	9. Program Level Same Delivery Mode	None
SBDI - Infrared Heating	CSBDI1025	HVAC	SBDI Measures		Electric	Direct Install	0.91	0.91	0.91	Median of 9 values from literature review	9. Program Level Same Delivery Mode	None
SBDI - Programmable Thermostats	CSBDI1026	HVAC	SBDI Measures		Natural Gas	Direct Install	0.91	0.91	0.91	Median of 9 values from literature review	9. Program Level Same Delivery Mode	None
SBDI - Programmable Thermostats	CSBDI1026	HVAC	SBDI Measures		Electric	Direct Install	0.91	0.91	0.91	Median of 9 values from literature review	9. Program Level Same Delivery Mode	None
SBDI - Boiler Reset Controls	CSBDI1027	HVAC	SBDI Measures		Natural Gas	Direct Install	0.91	0.91	0.91	Median of 9 values from literature review	9. Program Level Same Delivery Mode	None
SBDI - Dual Enthalpy Economizers	CSBDI1028	HVAC	SBDI Measures		Electric	Direct Install	0.91	0.91	0.91	Median of 9 values from literature review	9. Program Level Same	None

Measure	Unique ID #	End Use	Measure Group	PA	Fuel Type	Delivery Mode	NTG 2024	NTG 2025	NTG 2026	NTG Basis	Method	Variation
											Delivery Mode	
SBDI - Electronic Fuel-Use Economizers (Boilers, Furnaces, AC)	CSBDI1029	HVAC	SBDI Measures		Electric	Direct Install	0.91	0.91	0.91	Median of 9 values from literature review	9. Program Level Same Delivery Mode	None
SBDI - Electronic Fuel-Use Economizers (Boilers, Furnaces, AC)	CSBDI1029	HVAC	SBDI Measures		Natural Gas	Direct Install	0.91	0.91	0.91	Median of 9 values from literature review	9. Program Level Same Delivery Mode	None
SBDI - Demand-Controlled Ventilation Using CO2 Sensors	CSBDI1030	HVAC	SBDI Measures		Electric	Direct Install	0.91	0.91	0.91	Median of 9 values from literature review	9. Program Level Same Delivery Mode	None
SBDI - Demand-Controlled Ventilation Using CO2 Sensors	CSBDI1030	HVAC	SBDI Measures		Electric	Direct Install	0.91	0.91	0.91	Median of 9 values from literature review	9. Program Level Same Delivery Mode	None
SBDI - Low Flow Faucet Aerators and Showerheads	CSBDI1031	Waterheating	SBDI Measures		Natural Gas	Direct Install	0.91	0.91	0.91	Median of 9 values from literature review	9. Program Level Same Delivery Mode	None
SBDI - Low Flow Faucet Aerators and Showerheads	CSBDI1031	Waterheating	SBDI Measures		Electric	Direct Install	0.91	0.91	0.91	Median of 9 values from literature review	9. Program Level Same Delivery Mode	None
SBDI - Low Flow Pre-rinse Spray Valves	CSBDI1032	Waterheating	SBDI Measures		Natural Gas	Direct Install	0.91	0.91	0.91	Median of 9 values from literature review	9. Program Level Same Delivery Mode	None
SBDI - Low Flow Pre-rinse Spray Valves	CSBDI1032	Waterheating	SBDI Measures		Electric	Direct Install	0.91	0.91	0.91	Median of 9 values from literature review	9. Program Level Same Delivery Mode	None

Measure	Unique ID #	End Use	Measure Group	PA	Fuel Type	Delivery Mode	NTG 2024	NTG 2025	NTG 2026	NTG Basis	Method	Variation
SBDI - Pipe Insulation	CSBDI1033	Waterheating	SBDI Measures		Natural Gas	Direct Install	0.91	0.91	0.91	Median of 9 values from literature review	9. Program Level Same Delivery Mode	None
SBDI - Pipe Insulation	CSBDI1033	Waterheating	SBDI Measures		Electric	Direct Install	0.91	0.91	0.91	Median of 9 values from literature review	9. Program Level Same Delivery Mode	None
SBDI - Prescriptive Lighting - OTHER THAN LED Lamps A-Line, PAR, R, G, MR, and other specialty type lamps	CSBDI1034.1	Lighting	SBDI Measures		Electric	Direct Install	0.76	0.71	0.66	Median of 16 prescriptive lighting values from literature review	6. Similar Measure All Delivery Modes	f. Annual Decrease (5 percentage points) Due to Rapid Commercialization
SBDI - Prescriptive Lighting LED Lamps A-Line, PAR, R, G, MR, and other specialty type lamps	CSBDI1034.2	Lighting	SBDI Measures		Electric	Direct Install	0.00	0.00	0.00	Federal or state standard	3. Federal or State Standard	None
SBDI - Lighting Controls (Occupancy Sensors, High-Bay Occupancy Sensors, Photocell with Dimmable Ballast)	CSBDI1035	Lighting	SBDI Measures		Electric	Direct Install	0.76	0.71	0.66	Median of 16 prescriptive lighting values from literature review	6. Similar Measure All Delivery Modes	f. Annual Decrease (5 percentage points) Due to Rapid Commercialization
SBDI - Smart Thermostat	CSBDI1036	HVAC	SBDI Measures		Natural Gas	Direct Install	0.91	0.91	0.91	Median of 9 values from literature review	9. Program Level Same Delivery Mode	None
SBDI - Smart Thermostat	CSBDI1036	HVAC	SBDI Measures		Electric	Direct Install	0.91	0.91	0.91	Median of 9 values from literature review	9. Program Level Same Delivery Mode	None
Stack Economizer for Boilers	CSBDI11037	HVAC	SBDI Measures		Natural Gas		0.91	0.91	0.91	Median of 9 values from literature review	9. Program Level Same	None

Measure	Unique ID #	End Use	Measure Group	PA	Fuel Type	Delivery Mode	NTG 2024	NTG 2025	NTG 2026	NTG Basis	Method	Variation
											Delivery Mode	
Solid Door Reach-in Refrigerators	CK17030	Kitchen Equipment	Solid Door Reach-In		Electric	Down-stream	0.81	0.81	0.81	Median of 9 food services program value from literature review	9. Program Level Same Delivery Mode	None
Solid Door Reach-in Freezers	CK17031	Kitchen Equipment	Solid Door Reach-In		Electric	Down-stream	0.81	0.81	0.81	Median of 9 food services program value from literature review	9. Program Level Same Delivery Mode	None
Steam Cookers, unspecified	CK17023	Kitchen Equipment	Steam Cookers		Electric	Down-stream	0.81	0.81	0.81	Median of 9 food services program value from literature review	9. Program Level Same Delivery Mode	None
Commercial Steam Cooker	CK17024	Kitchen Equipment	Steam Cookers		Natural Gas	Down-stream	0.81	0.81	0.81	Median of 9 food services program value from literature review	9. Program Level Same Delivery Mode	None
Air Conditioning (AC) only - Split or Packaged, Tier 1 SEER 16	CV7001	HVAC	Unitary - Air Conditioners & Heat Pumps, < 5.4 tons (65,000 BTU/hr)		Electric	Down-stream	0.93	0.93	0.93	Median of 3 values from literature review for programs with non-specific cooling measures	9. Program Level Same Delivery Mode	None
Air Conditioning (AC) only - Split or Packaged, Tier 2 SEER 18	CV7002	HVAC	Unitary - Air Conditioners & Heat Pumps, < 5.4 tons (65,000 BTU/hr)		Electric	Down-stream	0.93	0.93	0.93	Median of 3 values from literature review for programs with non-specific cooling measures	9. Program Level Same Delivery Mode	None
Heat Pumps - Split or Packaged, Tier 1 SEER 16 EER 13 HSPF 10	CV7003	HVAC	Unitary - Air Conditioners & Heat Pumps, < 5.4 tons (65,000 BTU/hr)		Electric	Down-stream	0.83	0.80	0.77	Median of 2 HP specific program values from literature review	5. Similar Measure & Delivery Mode	e. Annual Decrease (3 percentage points) Due to Moderate Commercialization
Heat Pumps - Split or Packaged, Tier 2 SEER 18 EER 13 HSPF 10	CV7004	HVAC	Unitary - Air Conditioners & Heat Pumps, < 5.4 tons (65,000 BTU/hr)		Electric	Down-stream	0.83	0.80	0.77	Median of 2 HP specific program values from literature review	5. Similar Measure & Delivery Mode	e. Annual Decrease (3 percentage points) Due to Moderate Commercialization

Measure	Unique ID #	End Use	Measure Group	PA	Fuel Type	Delivery Mode	NTG 2024	NTG 2025	NTG 2026	NTG Basis	Method	Variation
Air Conditioning (AC) only - Split or Packaged	CV7005	HVAC	Unitary - Air Conditioners & Heat Pumps, > 5.4 tons (65,000 BTU/hr)		Electric	Down-stream	0.93	0.93	0.93	Median of 3 values from literature review for programs with non-specific cooling measures	9. Program Level Same Delivery Mode	None
Heat Pumps - Air Source - Split or Packaged	CV7006	HVAC	Unitary - Air Conditioners & Heat Pumps, > 5.4 tons (65,000 BTU/hr)		Electric	Down-stream	0.83	0.80	0.77	Median of 2 HP specific program values from literature review	5. Similar Measure & Delivery Mode	e. Annual Decrease (3 percentage points) Due to Moderate Commercialization
Central DX Air Conditioners - All Sizes	CV7009	HVAC	Unitary - Air Conditioners & Heat Pumps, Central DX Air Conditioners- All Sizes		Electric	Down-stream	0.93	0.93	0.93	Median of 3 values from literature review for programs with non-specific cooling measures	9. Program Level Same Delivery Mode	None
Single Package Vertical Air Conditioner - ALL SIZES	CV7007	HVAC	Unitary - Air Conditioners & Heat Pumps, Single Package Vertical		Electric	Down-stream	0.93	0.93	0.93	Median of 3 values from literature review for programs with non-specific cooling measures	9. Program Level Same Delivery Mode	None
Single Package Vertical Heat Pump - ALL SIZES	CV7008	HVAC	Unitary - Air Conditioners & Heat Pumps, Single Package Vertical		Electric	Down-stream	0.83	0.80	0.77	Median of 2 HP specific program values from literature review	5. Similar Measure & Delivery Mode	e. Annual Decrease (3 percentage points) Due to Moderate Commercialization
Vending machine controls, Non-Refrigerated	CP5007	Plug Loads	Vending Machine Controls		Electric	Down-stream	0.77	0.77	0.77	Median of 2 values from literature review	9. Program Level Same Delivery Mode	g. 10% Decrease Due to Common Nature of Measure
Vending machine controls, Refrigerated	CP5008	Plug Loads	Vending Machine Controls		Electric	Down-stream	0.77	0.77	0.77	Median of 2 values from literature review	9. Program Level Same Delivery Mode	g. 10% Decrease Due to Common Nature of Measure
VFD < 100 hp	CD15001	VFD / Drives	VFD - Variable Frequency Drives		Electric	Down-stream	0.65	0.65	0.65	Median of 8 values from literature review	9. Program Level Same Delivery Mode	None

Measure	Unique ID #	End Use	Measure Group	PA	Fuel Type	Delivery Mode	NTG 2024	NTG 2025	NTG 2026	NTG Basis	Method	Variation
VFD >100 to <200	CD15002	VFD / Drives	VFD - Variable Frequency Drives		Electric	Down-stream	0.65	0.65	0.65	Median of 8 values from literature review	9. Program Level Same Delivery Mode	None
Water-cooled & Evaporative Cooling Air Conditioners - All Sizes	CNMR-1	HVAC	Water Cooled & Evaporative Cooling Air Conditioners - All Sizes		Electric	Down-stream	0.93	0.93	0.93	Median of 3 values from literature review for programs with non-specific cooling measures	9. Program Level Same Delivery Mode	None
Desuperheater	CNMR-4	Waterheating	Water Heating	Rockland	Electric		0.71	0.71	0.71	Median of 6 values from literature review	9. Program Level Same Delivery Mode	None
Heat Pump Water Heater - C&I	CW3001	Waterheating	Water Heating		Electric	Down-stream	0.71	0.71	0.71	Median of 6 values from literature review	9. Program Level Same Delivery Mode	None
DHW Storage, Gas-Fired, < 75,000 Btuh, (<55gallons), (75 MBH) > 0.67 EF or 0.64 UEF	CW3002	Waterheating	Water Heating, Natural Gas		Natural Gas	Down-stream	0.71	0.71	0.71	Median of 6 values from literature review	9. Program Level Same Delivery Mode	None
DHW Storage, Gas-Fired, < 75,000 Btuh, (>55gallons) (75 MBH) > 0.81 UEF	CW3003	Waterheating	Water Heating, Natural Gas		Natural Gas	Down-stream	0.71	0.71	0.71	Median of 6 values from literature review	9. Program Level Same Delivery Mode	None
DHW Storage, Gas-Fired, 75,000 to 105,000 Btuh, > 82% TE (Should be TE Thermal Efficiency)	CW3004	Waterheating	Water Heating, Natural Gas		Natural Gas	Down-stream	0.71	0.71	0.71	Median of 6 values from literature review	9. Program Level Same Delivery Mode	None
DHW Storage, Gas-Fired, 75,000 to 105,000 Btuh,	CW3005	Waterheating	Water Heating, Natural Gas		Natural Gas	Down-stream	0.71	0.71	0.71	Median of 6 values from literature review	9. Program Level Same Delivery Mode	None

Measure	Unique ID #	End Use	Measure Group	PA	Fuel Type	Delivery Mode	NTG 2024	NTG 2025	NTG 2026	NTG Basis	Method	Variation
> 94% TE (Should be TE Thermal Efficiency)												
DHW Storage, Gas-Fired, > 105,000 Btuh (105 MBH), > 82% TE (Should be TE Thermal Efficiency)	CW3006	Waterheating	Water Heating, Natural Gas		Natural Gas	Down-stream	0.71	0.71	0.71	Median of 6 values from literature review	9. Program Level Same Delivery Mode	None
DHW Storage, Gas-Fired, > 105,000 Btuh (105 MBH), > 94% TE (Should be TE Thermal Efficiency)	CW3007	Waterheating	Water Heating, Natural Gas		Natural Gas	Down-stream	0.71	0.71	0.71	Median of 6 values from literature review	9. Program Level Same Delivery Mode	None
DHW, Instant, Gas-Fired, < 200,000 Btuh, > 90% TE (Should be TE Thermal Efficiency)	CW3008	Waterheating	Water Heating, Natural Gas		Natural Gas	Down-stream	0.71	0.71	0.71	Median of 6 values from literature review	9. Program Level Same Delivery Mode	None
DHW, Instant, Gas-Fired, > 200,000 Btuh, > 90% TE (Should be TE Thermal Efficiency)	CW3009	Waterheating	Water Heating, Natural Gas		Natural Gas	Down-stream	0.71	0.71	0.71	Median of 6 values from literature review	9. Program Level Same Delivery Mode	None
Gas Cooling Application Regenerative Desiccant Unit GC7	CNMR-11	HVAC		NJCEP	Natural Gas		0.80	0.80	0.80	Median of 35 downstream prescriptive program values from literature review	9. Program Level Same Delivery Mode	a. Removed Outliers
Wrapped Lens	CNMR-3	Lighting		PSE&G	Electric		0.58	0.53	0.48	Median of 16 linear lamp and fixture values from literature review	7. Partial Measure Group	f. Annual Decrease (5 percentage points) Due to Rapid Commercialization
Gas Heating Domestic Hot Water Pipe Wrap Insulation ≤0.5" Diameter GH31 > 0.5" Diameter GH32	CNMR-8	Waterheating		NJCEP	Natural Gas		0.71	0.71	0.71	Median of 6 values from literature review	9. Program Level Same Delivery Mode	None

11.2 RESIDENTIAL NTG

Measure	Unique ID #	Program	Measure Group	PA	Fuel Type	Delivery Mode	NTG 2024	NTG 2025	NTG 2026	NTG Basis	Method	Variation
Multifamily - Unless otherwise specified							See Method	See Method	See Method		Apply Residential NTG Ratios to In-Unit Measures and Commercial NTG Ratios to Common Area Measures	
Clothes Washer Tier 1	RA2001	Efficient Products	Appliances	Utilities	Electric	Downstream	0.51	0.51	0.51	Median of 3 values from literature	4. Multiple Directly Comparable Sources	a. Removed Outliers
Clothes Washer Tier 2	RA2002	Efficient Products	Appliances	Utilities	Electric	Downstream	0.51	0.51	0.51	Median of 3 values from literature	4. Multiple Directly Comparable Sources	a. Removed Outliers
Clothes Dryer Tier 1	RA2003	Efficient Products	Appliances	Utilities	Electric	Downstream	0.58	0.58	0.58	Median of 6 values from literature	4. Multiple Directly Comparable Sources	None
Clothes Dryer Tier 2	RA2004	Efficient Products	Appliances	Utilities	Electric	Downstream	0.58	0.58	0.58	Median of 6 values from literature	4. Multiple Directly Comparable Sources	None
Clothes Dryer Gas - Tier 1	RA2005	Efficient Products	Appliances	Utilities	Natural Gas	Downstream	0.58	0.58	0.58	Median of 6 values from literature	4. Multiple Directly Comparable Sources	None
Refrigerator Tier 1	RA2006	Efficient Products	Appliances	Utilities	Electric	Downstream	0.47	0.47	0.47	Median of 6 values from literature	4. Multiple Directly Comparable Sources	a. Removed Outliers
Refrigerator Tier 2	RA2007	Efficient Products	Appliances	Utilities	Electric	Downstream	0.47	0.47	0.47	Median of 6 values from literature	4. Multiple Directly Comparable Sources	a. Removed Outliers

Measure	Unique ID #	Program	Measure Group	PA	Fuel Type	Delivery Mode	NTG 2024	NTG 2025	NTG 2026	NTG Basis	Method	Variation
Refrigerator Compact (<7.75 CF)	RA2008	Efficient Products	Appliances	Utilities	Electric	Down-stream	0.47	0.47	0.47	Median of 6 values from literature	4. Multiple Directly Comparable Sources	a. Removed Outliers
Freezers	RA2009	Efficient Products	Appliances	Utilities	Electric	Down-stream	0.52	0.52	0.52	Median of 26 kitchen and laundry appliance values in literature	7. Partial Measure Group	a. Removed Outliers
Dishwasher	RA2010	Efficient Products	Appliances	Utilities	Electric	Down-stream	0.52	0.52	0.52	Median of 26 kitchen and laundry appliance values in literature	7. Partial Measure Group	a. Removed Outliers
Induction Cooktop Stove	RA2011	Efficient Products	Appliances	Utilities	Electric	Down-stream	0.67	0.67	0.67	Evaluator Assigned based on market data	10. Evaluator Assigned	I. Broad Market Trends
Air Purifier / Cleaner	RA2012	Efficient Products	Appliances	Utilities	Electric	Online	0.65	0.65	0.65	Median of 13 values from literature	4. Multiple Directly Comparable Sources	a. Removed Outliers
Air Purifier / Cleaner	RA2012	Efficient Products	Appliances	Utilities	Electric	Upstream	0.65	0.65	0.65	Median of 13 values from literature	4. Multiple Directly Comparable Sources	a. Removed Outliers
Room A/C Unit	RA2013	Efficient Products	Appliances	Utilities	Electric	Upstream	0.54	0.54	0.54	Median of 9 values from literature	4. Multiple Directly Comparable Sources	None
Dehumidifier	RA2014	Efficient Products	Appliances	Utilities	Electric	Online	0.49	0.49	0.49	Median of 12 values from literature	4. Multiple Directly Comparable Sources	None
Dehumidifier	RA2014	Efficient Products	Appliances	Utilities	Electric	Upstream	0.49	0.49	0.49	Median of 12 values from literature	4. Multiple Directly Comparable Sources	None

Measure	Unique ID #	Program	Measure Group	PA	Fuel Type	Delivery Mode	NTG 2024	NTG 2025	NTG 2026	NTG Basis	Method	Variation
Pool Pump - Variable Speed	RA2021	Efficient Products	Appliances	Utilities	Electric	Downstream	0.86	0.86	0.86	Median of 7 values from literature	4. Multiple Directly Comparable Sources	None
Sound Bars	RA2022	Efficient Products	Appliances	Utilities	Electric	Downstream	0.83	0.83	0.83	Median of 2 values from literature	4. Multiple Directly Comparable Sources	None
Water Cooler	RA2023	Efficient Products	Appliances	Utilities	Electric	Downstream	0.52	0.52	0.52	Median of 26 kitchen and laundry appliance values in literature	7. Partial Measure Group	a. Removed Outliers
Electric Vehicle Charger - Multifamily	RA2024	Efficient Products	Appliances	Utilities	Electric	Downstream	0.87	0.84	0.81	Evaluator Assigned based on market data	10. Evaluator Assigned	k. National Shipment Data
Electric Vehicle Charger - Single Family	RA2024	Efficient Products	Appliances	Utilities	Electric	Downstream	0.77	0.74	0.71	Evaluator Assigned based on market data	10. Evaluator Assigned	k. National Shipment Data
Clothes Dryer - Multifamily all tiers		Efficient Products	Appliances	Utilities	Electric	Downstream	0.64	0.64	0.64	Median of 6 values from literature	4. Multiple Directly Comparable Sources	b. 10% Multifamily Boost
Room A/C Unit - Multifamily		Efficient Products	Appliances	Utilities	Electric	All modes	0.59	0.59	0.59	Median of 9 values from literature	4. Multiple Directly Comparable Sources	b. 10% Multifamily Boost
Dishwasher - Multifamily		Efficient Products	Appliances	Utilities	Electric	Downstream	0.57	0.57	0.57	Median of 26 kitchen and laundry appliance values in literature	7. Partial Measure Group	a. Removed Outliers; b. 10% Multifamily Boost
Clothes Washer - Multifamily all tiers		Efficient Products	Appliances	Utilities	Electric	Downstream	0.56	0.56	0.56	Median of 3 values from literature	4. Multiple Directly Comparable Sources	a. Removed Outliers; b. 10% Multifamily Boost

Measure	Unique ID #	Program	Measure Group	PA	Fuel Type	Delivery Mode	NTG 2024	NTG 2025	NTG 2026	NTG Basis	Method	Variation
Refrigerator - Multifamily, all tiers		Efficient Products	Appliances	Utilities	Electric	Downstream	0.52	0.52	0.52	Median of 6 values from literature	4. Multiple Directly Comparable Sources	a. Removed Outliers; b. 10% Multifamily Boost
Refrigerator Recycling (between 10-30 cubic feet)	RE6001	Efficient Products	Early Retirement / Recycling	Utilities	Electric	Downstream	0.51	0.51	0.51	Median of 19 values from literature	5. Similar Measures, Delivery Mode	None
Freezer Recycling (between 10-30 cubic feet)	RE6002	Efficient Products	Early Retirement / Recycling	Utilities	Electric	Downstream	0.58	0.58	0.58	Median of 14 values from literature	5. Similar Measures, Delivery Mode	None
Room A/C Unit Recycling	RE6003	Efficient Products	Early Retirement / Recycling	Utilities	Electric	Downstream	0.50	0.50	0.50	Median of 6 values from literature	5. Similar Measures, Delivery Mode	None
Dehumidifier Recycling	RE6004	Efficient Products	Early Retirement / Recycling	Utilities	Electric	Downstream	0.41	0.41	0.41	Median of 7 values from literature	5. Similar Measures, Delivery Mode	None
Circulating Pump	RF8001	Efficient Products	Fans & Pumps	Utilities	Electric	Hybrid	0.80	0.80	0.80	Median of 3 values from literature	6. Similar Measures, All Delivery Modes	d. 5% Hybrid Incentive Boost
Circulating Pump	RF8001	Efficient Products	Fans & Pumps	Utilities	Electric	Downstream	0.76	0.76	0.76	Median of 3 values from literature	6. Similar Measures, All Delivery Modes	None
Circulating Pump (Gas)	RF8002	Efficient Products	Fans & Pumps	Utilities	Natural Gas	Hybrid	0.80	0.80	0.80	Median of 3 values from literature	6. Similar Measures, All Delivery Modes	d. 5% Hybrid Incentive Boost
Circulating Pump (Gas)	RF8002	Efficient Products	Fans & Pumps	Utilities	Natural Gas	Downstream	0.76	0.76	0.76	Median of 3 values from literature	6. Similar Measures, All Delivery Modes	None
Bathroom Fan	RF8003	Efficient Products	Fans & Pumps	Utilities	Electric	Hybrid	0.63	0.63	0.63	Median of 10 program-level values in literature	9. Program Level, Same Delivery Mode	d. 5% Hybrid Incentive Boost

Measure	Unique ID #	Program	Measure Group	PA	Fuel Type	Delivery Mode	NTG 2024	NTG 2025	NTG 2026	NTG Basis	Method	Variation
Bathroom Fan	RF8003	Efficient Products	Fans & Pumps	Utilities	Electric	Down-stream	0.60	0.60	0.60	Median of 10 program-level values in literature	9. Program Level, Same Delivery Mode	none
Smart Thermostats - Gas Heat and no CAC or muni	RA2015	Efficient Products	HVAC	Utilities	Natural Gas	Online	0.74	0.71	0.68	Median of 8 values from literature	6. Similar Measures, All Delivery Modes	f. Annual Decrease (3 percentage points) Due to Moderate Commercialization
Smart Thermostats - Gas Heat and no CAC or muni	RA2015	Efficient Products	HVAC	Utilities	Natural Gas	Upstream	0.74	0.71	0.68	Median of 8 values from literature	6. Similar Measures, All Delivery Modes	f. Annual Decrease (3 percentage points) Due to Moderate Commercialization
Smart Thermostats - Gas Heat and no CAC or muni	RA2015	Efficient Products	HVAC	Utilities	Natural Gas	Down-stream	0.74	0.71	0.68	Median of 8 values from literature	6. Similar Measures, All Delivery Modes	f. Annual Decrease (3 percentage points) Due to Moderate Commercialization
Smart Thermostats - Gas Heat w/ CAC	RA2016	Efficient Products	HVAC	Utilities	Natural Gas	Online	0.74	0.71	0.68	Median of 8 values from literature	6. Similar Measures, All Delivery Modes	f. Annual Decrease (3 percentage points) Due to Moderate Commercialization
Smart Thermostats - Gas Heat w/ CAC	RA2016	Efficient Products	HVAC	Utilities	Electric	Online	0.74	0.71	0.68	Median of 8 values from literature	6. Similar Measures, All Delivery Modes	f. Annual Decrease (3 percentage points) Due to Moderate Commercialization
Smart Thermostats - Gas Heat w/ CAC	RA2016	Efficient Products	HVAC	Utilities	Natural Gas	Upstream	0.74	0.71	0.68	Median of 8 values from literature	6. Similar Measures, All Delivery Modes	f. Annual Decrease (3 percentage points) Due to Moderate Commercialization
Smart Thermostats - Gas Heat w/ CAC	RA2016	Efficient Products	HVAC	Utilities	Electric	Upstream	0.74	0.71	0.68	Median of 8 values from literature	6. Similar Measures, All Delivery Modes	f. Annual Decrease (3 percentage points) Due to Moderate Commercialization
Smart Thermostats - Gas Heat w/ CAC	RA2016	Efficient Products	HVAC	Utilities	Natural Gas	Down-stream	0.74	0.71	0.68	Median of 8 values from literature	6. Similar Measures, All Delivery Modes	f. Annual Decrease (3 percentage points) Due to Moderate Commercialization
Smart Thermostats - Gas Heat w/ CAC	RA2016	Efficient Products	HVAC	Utilities	Electric	Down-stream	0.74	0.71	0.68	Median of 8 values from literature	6. Similar Measures, All Delivery Modes	f. Annual Decrease (3 percentage points) Due to Moderate Commercialization

Measure	Unique ID #	Program	Measure Group	PA	Fuel Type	Delivery Mode	NTG 2024	NTG 2025	NTG 2026	NTG Basis	Method	Variation
Smart Thermostats - Electric A/C and Elec Heat	RA2017	Efficient Products	HVAC	Utilities	Electric	Online	0.74	0.71	0.68	Median of 8 values from literature	6. Similar Measures, All Delivery Modes	f. Annual Decrease (3 percentage points) Due to Moderate Commercialization
Smart Thermostats - Electric A/C and Elec Heat	RA2017	Efficient Products	HVAC	Utilities	Electric	Upstream	0.74	0.71	0.68	Median of 8 values from literature	6. Similar Measures, All Delivery Modes	f. Annual Decrease (3 percentage points) Due to Moderate Commercialization
Smart Thermostats - Electric A/C and Elec Heat	RA2017	Efficient Products	HVAC	Utilities	Electric	Downstream	0.74	0.71	0.68	Median of 8 values from literature	6. Similar Measures, All Delivery Modes	f. Annual Decrease (3 percentage points) Due to Moderate Commercialization
Smart Thermostat - Electric A/C and No Natural Gas	RA2018	Efficient Products	HVAC	Utilities	Electric	Online	0.74	0.71	0.68	Median of 8 values from literature	6. Similar Measures, All Delivery Modes	f. Annual Decrease (3 percentage points) Due to Moderate Commercialization
Smart Thermostat - Electric A/C and No Natural Gas	RA2018	Efficient Products	HVAC	Utilities	Electric	Upstream	0.74	0.71	0.68	Median of 8 values from literature	6. Similar Measures, All Delivery Modes	f. Annual Decrease (3 percentage points) Due to Moderate Commercialization
Smart Thermostat - Electric A/C and No Natural Gas	RA2018	Efficient Products	HVAC	Utilities	Electric	Downstream	0.74	0.71	0.68	Median of 8 values from literature	6. Similar Measures, All Delivery Modes	f. Annual Decrease (3 percentage points) Due to Moderate Commercialization
Smart Thermostats - No Central A/C and Elec Heat	RA2019	Efficient Products	HVAC	Utilities	Electric	Online	0.74	0.71	0.68	Median of 8 values from literature	6. Similar Measures, All Delivery Modes	f. Annual Decrease (3 percentage points) Due to Moderate Commercialization
Smart Thermostats - No Central A/C and Elec Heat	RA2019	Efficient Products	HVAC	Utilities	Electric	Upstream	0.74	0.71	0.68	Median of 8 values from literature	6. Similar Measures, All Delivery Modes	f. Annual Decrease (3 percentage points) Due to Moderate Commercialization
Smart Thermostats - No Central A/C and Elec Heat	RA2019	Efficient Products	HVAC	Utilities	Electric	Downstream	0.74	0.71	0.68	Median of 8 values from literature	6. Similar Measures, All Delivery Modes	f. Annual Decrease (3 percentage points) Due to Moderate Commercialization
Smart Thermostats	RA2020	Efficient Products	HVAC	Utilities	Natural Gas	Online	0.74	0.71	0.68	Median of 8 values from literature	6. Similar Measures, All Delivery Modes	f. Annual Decrease (3 percentage points) Due to Moderate Commercialization
Smart Thermostats	RA2020	Efficient Products	HVAC	Utilities	Electric	Online	0.74	0.71	0.68	Median of 8 values from literature	6. Similar Measures, All Delivery Modes	f. Annual Decrease (3 percentage points) Due to Moderate Commercialization

Measure	Unique ID #	Program	Measure Group	PA	Fuel Type	Delivery Mode	NTG 2024	NTG 2025	NTG 2026	NTG Basis	Method	Variation
Smart Thermostats	RA2020	Efficient Products	HVAC	Utilities	Natural Gas	Upstream	0.74	0.71	0.68	Median of 8 values from literature	6. Similar Measures, All Delivery Modes	f. Annual Decrease (3 percentage points) Due to Moderate Commercialization
Smart Thermostats	RA2020	Efficient Products	HVAC	Utilities	Electric	Upstream	0.74	0.71	0.68	Median of 8 values from literature	6. Similar Measures, All Delivery Modes	f. Annual Decrease (3 percentage points) Due to Moderate Commercialization
Smart Thermostats	RA2020	Efficient Products	HVAC	Utilities	Natural Gas	Downstream	0.74	0.71	0.68	Median of 8 values from literature	6. Similar Measures, All Delivery Modes	f. Annual Decrease (3 percentage points) Due to Moderate Commercialization
Smart Thermostats	RA2020	Efficient Products	HVAC	Utilities	Electric	Downstream	0.74	0.71	0.68	Median of 8 values from literature	6. Similar Measures, All Delivery Modes	f. Annual Decrease (3 percentage points) Due to Moderate Commercialization
Central Air Conditioning Tier 1 (SEER >=16, EER >=12.5)	RV7001	Efficient Products	HVAC	Utilities	Electric	Hybrid	0.78	0.78	0.78	Median of 7 values from literature	6. Similar Measures, All Delivery Modes	d. 5% Hybrid Incentive Boost
Central Air Conditioning Tier 1 (SEER >=16, EER >=12.5)	RV7001	Efficient Products	HVAC	Utilities	Electric	Downstream	0.74	0.74	0.74	Median of 7 values from literature	5. Similar Measures, Delivery Mode	None
Central Air Conditioning Tier 2 (SEER >=18, EER >=13)	RV7002	Efficient Products	HVAC	Utilities	Electric	Hybrid	0.78	0.78	0.78	Median of 7 values from literature	6. Similar Measures, All Delivery Modes	d. 5% Hybrid Incentive Boost
Central Air Conditioning Tier 2 (SEER >=18, EER >=13)	RV7002	Efficient Products	HVAC	Utilities	Electric	Downstream	0.74	0.74	0.74	Median of 7 values from literature	5. Similar Measures, Delivery Mode	None
Air Source Heat Pump Tier 1 (SEER >=16, EER >=12.5, HSPF >=9)	RV7003	Efficient Products	HVAC	Utilities	Electric	Hybrid	0.75	0.72	0.69	Median of 15 values from literature (including single value reserved for fuel switching)	6. Similar Measures, All Delivery Modes	d. 5% Boost for Hybrid Incentive; f. Annual Decrease (3 percentage points) Due to Moderate Commercialization

Measure	Unique ID #	Program	Measure Group	PA	Fuel Type	Delivery Mode	NTG 2024	NTG 2025	NTG 2026	NTG Basis	Method	Variation
Air Source Heat Pump Tier 1 (SEER >=16, EER >=12.5, HSPF >=9)	RV7003	Efficient Products	HVAC	Utilities	Electric	Down-stream	0.71	0.68	0.65	Median of 15 values from literature (including single value reserved for fuel switching)	6. Similar Measures, All Delivery Modes	f. Annual Decrease (3 percentage points) Due to Moderate Commercialization
Air Source Heat Pump Tier 1 (SEER >=16, EER >=12.5, HSPF >=9)	RV7003	Efficient Products	HVAC	Utilities	Electric	Hybrid	0.68	0.65	0.62	Median of 14 values from literature (excluding single value reserved for fuel switching)	6. Similar Measures, All Delivery Modes	d. 5% Boost for Hybrid Incentive; f. Annual Decrease (3 percentage points) Due to Moderate Commercialization
Air Source Heat Pump Tier 1 (SEER >=16, EER >=12.5, HSPF >=9)	RV7003	Efficient Products	HVAC	Utilities	Electric	Down-stream	0.65	0.62	0.59	Median of 14 values from literature (excluding single value reserved for fuel switching)	6. Similar Measures, All Delivery Modes	f. Annual Decrease (3 percentage points) Due to Moderate Commercialization
Air Source Heat Pump Tier 2 (SEER >=18, EER >=13, HSPF >=10)	RV7004	Efficient Products	HVAC	Utilities	Electric	Hybrid	0.75	0.72	0.69	Median of 15 values from literature (including single value reserved for fuel switching)	6. Similar Measures, All Delivery Modes	d. 5% Boost for Hybrid Incentive; f. Annual Decrease (3 percentage points) Due to Moderate Commercialization
Air Source Heat Pump Tier 2 (SEER >=18, EER >=13, HSPF >=10)	RV7004	Efficient Products	HVAC	Utilities	Electric	Down-stream	0.71	0.68	0.65	Median of 15 values from literature (including single value reserved for fuel switching)	6. Similar Measures, All Delivery Modes	f. Annual Decrease (3 percentage points) Due to Moderate Commercialization
Air Source Heat Pump Tier 2 (SEER >=18, EER >=13, HSPF >=10)	RV7004	Efficient Products	HVAC	Utilities	Electric	Hybrid	0.68	0.65	0.62	Median of 14 values from literature (excluding single value reserved for fuel switching)	6. Similar Measures, All Delivery Modes	d. 5% Boost for Hybrid Incentive; f. Annual Decrease (3 percentage points) Due to Moderate Commercialization

Measure	Unique ID #	Program	Measure Group	PA	Fuel Type	Delivery Mode	NTG 2024	NTG 2025	NTG 2026	NTG Basis	Method	Variation
Air Source Heat Pump Tier 2 (SEER >=18, EER >=13, HSPF >=10)	RV7004	Efficient Products	HVAC	Utilities	Electric	Down-stream	0.65	0.62	0.59	Median of 14 values from literature (excluding single value reserved for fuel switching)	6. Similar Measures, All Delivery Modes	f. Annual Decrease (3 percentage points) Due to Moderate Commercialization
Air Source Heat Pump - Cold Climate (SEER >=18, EER >=12, HSPF >=10, and COP >=1.75 at 5 def F)	RV7005	Efficient Products	HVAC	Utilities	Electric	Hybrid	0.82	0.79	0.76	Median of 15 values from literature (including single value reserved for fuel switching)	6. Similar Measures, All Delivery Modes	d. 5% Hybrid Incentive Boost; e. 10% Cold Climate Boost; f. Annual Decrease (3 percentage points) Due to Moderate Commercialization
Air Source Heat Pump - Cold Climate (SEER >=18, EER >=12, HSPF >=10, and COP >=1.75 at 5 def F)	RV7005	Efficient Products	HVAC	Utilities	Electric	Down-stream	0.78	0.75	0.72	Median of 15 values from literature (including single value reserved for fuel switching)	6. Similar Measures, All Delivery Modes	e. 10% Cold Climate Boost; f. Annual Decrease (3 percentage points) Due to Moderate Commercialization
Air Source Heat Pump - Cold Climate (SEER >=18, EER >=12, HSPF >=10, and COP >=1.75 at 5 def F)	RV7005	Efficient Products	HVAC	Utilities	Electric	Hybrid	0.75	0.72	0.69	Median of 14 values from literature (excluding single value reserved for fuel switching)	6. Similar Measures, All Delivery Modes	d. 5% Hybrid Incentive Boost; e. 10% Cold Climate Boost; f. Annual Decrease (3 percentage points) Due to Moderate Commercialization
Air Source Heat Pump - Cold Climate (SEER >=18, EER >=12, HSPF >=10, and COP >=1.75 at 5 def F)	RV7005	Efficient Products	HVAC	Utilities	Electric	Down-stream	0.72	0.69	0.66	Median of 14 values from literature (excluding single value reserved for fuel switching)	6. Similar Measures, All Delivery Modes	e. 10% Cold Climate Boost; f. Annual Decrease (3 percentage points) Due to Moderate Commercialization
Air to Water Heat Pump (COP >1.75 at full load capacity and 110 deg F water temp)	RV7006	Efficient Products	HVAC	Utilities	Electric	Hybrid	0.82	0.82	0.82	Median of 2 values from literature	6. Similar Measures, All Delivery Modes	d. 5% Hybrid Incentive Boost

Measure	Unique ID #	Program	Measure Group	PA	Fuel Type	Delivery Mode	NTG 2024	NTG 2025	NTG 2026	NTG Basis	Method	Variation
Air to Water Heat Pump (COP >1.75 at full load capacity and 110 deg F water temp)	RV7006	Efficient Products	HVAC	Utilities	Electric	Down-stream	0.78	0.78	0.78	Median of 2 values from literature	6. Similar Measures, All Delivery Modes	None
Geothermal Heat Pump Energy Star Closed Loop Wtr to Air EER >= 17.1 Closed Loop Wtr to Wtr EER >= 21.1 Open Loop Wtr to Air EER >= 16.1 Open Loop Wtr to Wtr EER >= 20.1	RV7007	Efficient Products	HVAC	Utilities	Electric	Hybrid	0.72	0.72	0.72	Evaluator Assigned based on market data	10. Evaluator Assigned	I. Broad Market Trends
Geothermal Heat Pump Energy Star Closed Loop Wtr to Air EER >= 17.1 Closed Loop Wtr to Wtr EER >= 21.1 Open Loop Wtr to Air EER >= 16.1 Open Loop Wtr to Wtr EER >= 20.1	RV7007	Efficient Products	HVAC	Utilities	Electric	Down-stream	0.67	0.67	0.67	Evaluator Assigned based on market data	10. Evaluator Assigned	I. Broad Market Trends
Ductless Mini-Split Heat Pump Multi (SEER >= 18, EER >=12.5 or HSPF >= 10) Single (SEER >= 20, EER >=12.5 or HSPF >= 10)	RV7008	Efficient Products	HVAC	Utilities	Electric	Hybrid	0.75	0.72	0.69	Median of 15 values from literature (including single value reserved for fuel switching)	6. Similar Measures, All Delivery Modes	d. 5% Boost for Hybrid Incentive; f. Annual Decrease (3 percentage points) Due to Moderate Commercialization

Measure	Unique ID #	Program	Measure Group	PA	Fuel Type	Delivery Mode	NTG 2024	NTG 2025	NTG 2026	NTG Basis	Method	Variation
Ductless Mini-Split Heat Pump Multi (SEER >= 18, EER >=12.5 or HSPF >= 10) Single (SEER >= 20, EER >=12.5 or HSPF >= 10)	RV7008	Efficient Products	HVAC	Utilities	Electric	Down-stream	0.71	0.68	0.65	Median of 15 values from literature (including single value reserved for fuel switching)	6. Similar Measures, All Delivery Modes	f. Annual Decrease (3 percentage points) Due to Moderate Commercialization
Ductless Mini-Split Heat Pump Multi (SEER >= 18, EER >=12.5 or HSPF >= 10) Single (SEER >= 20, EER >=12.5 or HSPF >= 10)	RV7008	Efficient Products	HVAC	Utilities	Electric	Hybrid	0.68	0.65	0.62	Median of 14 values from literature (excluding single value reserved for fuel switching)	6. Similar Measures, All Delivery Modes	d. 5% Boost for Hybrid Incentive; f. Annual Decrease (3 percentage points) Due to Moderate Commercialization
Ductless Mini-Split Heat Pump Multi (SEER >= 18, EER >=12.5 or HSPF >= 10) Single (SEER >= 20, EER >=12.5 or HSPF >= 10)	RV7008	Efficient Products	HVAC	Utilities	Electric	Down-stream	0.65	0.62	0.59	Median of 14 values from literature (excluding single value reserved for fuel switching)	6. Similar Measures, All Delivery Modes	f. Annual Decrease (3 percentage points) Due to Moderate Commercialization
Ductless Mini Split A/C (SEER >= 20, EER >=12.5)	RV7009	Efficient Products	HVAC	Utilities	Electric	Hybrid	0.75	0.72	0.69	Median of 15 values from literature (including single value reserved for fuel switching)	6. Similar Measures, All Delivery Modes	d. 5% Boost for Hybrid Incentive; f. Annual Decrease (3 percentage points) Due to Moderate Commercialization
Ductless Mini Split A/C (SEER >= 20, EER >=12.5)	RV7009	Efficient Products	HVAC	Utilities	Electric	Down-stream	0.71	0.68	0.65	Median of 15 values from literature (including single value reserved for fuel switching)	6. Similar Measures, All Delivery Modes	f. Annual Decrease (3 percentage points) Due to Moderate Commercialization

Measure	Unique ID #	Program	Measure Group	PA	Fuel Type	Delivery Mode	NTG 2024	NTG 2025	NTG 2026	NTG Basis	Method	Variation
Ductless Mini Split A/C (SEER >= 20, EER >=12.5)	RV7009	Efficient Products	HVAC	Utilities	Electric	Hybrid	0.68	0.65	0.62	Median of 14 values from literature (excluding single value reserved for fuel switching)	6. Similar Measures, All Delivery Modes	d. 5% Boost for Hybrid Incentive; f. Annual Decrease (3 percentage points) Due to Moderate Commercialization
Ductless Mini Split A/C (SEER >= 20, EER >=12.5)	RV7009	Efficient Products	HVAC	Utilities	Electric	Downstream	0.65	0.62	0.59	Median of 14 values from literature (excluding single value reserved for fuel switching)	6. Similar Measures, All Delivery Modes	f. Annual Decrease (3 percentage points) Due to Moderate Commercialization
Furnace Fans (ECM motor install)	RV7010	Efficient Products	HVAC	Utilities	Electric	Hybrid	0.66	0.66	0.66	Median of 3 values from literature	6. Similar Measures, All Delivery Modes	d. 5% Hybrid Incentive Boost
Furnace Fans (ECM motor install)	RV7010	Efficient Products	HVAC	Utilities	Electric	Downstream	0.63	0.63	0.63	Median of 3 values from literature	5. Similar Measures, Delivery Mode	None
PTAC - CEE Tier 2 - Multi Family	RV7011	Efficient Products	HVAC	Utilities	Electric	Downstream	0.93	0.93	0.93	Median of 2 MF values from literature	6. Similar Measures, All Delivery Modes	None
PTAC - CEE Tier 2 - Multi Family	RV7011	Efficient Products	HVAC	Utilities	Electric	Downstream	0.93	0.93	0.93	Median of 2 MF values from literature	6. Similar Measures, All Delivery Modes	None
PTHP - CEE Tier 2- Multi Family	RV7012	Efficient Products	HVAC	Utilities	Electric	Hybrid	0.93	0.93	0.93	Median of 2 MF values from literature	6. Similar Measures, All Delivery Modes	None
PTHP - CEE Tier 2- Multi Family	RV7012	Efficient Products	HVAC	Utilities	Electric	Hybrid	0.93	0.93	0.93	Median of 2 MF values from literature	6. Similar Measures, All Delivery Modes	None
Reset controls for boiler	RV7013	Efficient Products	HVAC	Utilities	Natural Gas	Hybrid	0.80	0.80	0.80	Evaluator Assigned based on market data	10. Evaluator Assigned	I. Broad Market Trends

Measure	Unique ID #	Program	Measure Group	PA	Fuel Type	Delivery Mode	NTG 2024	NTG 2025	NTG 2026	NTG Basis	Method	Variation
Reset controls for boiler	RV7013	Efficient Products	HVAC	Utilities	Natural Gas	Down-stream	0.75	0.75	0.75	Evaluator Assigned based on market data	10. Evaluator Assigned	I. Broad Market Trends
Gas Boiler (90-95% AFUE)5	RV7014	Efficient Products	HVAC	Utilities	Natural Gas	Hybrid	0.80	0.80	0.80	Median of all 11 values from literature	6. Similar Measures, All Delivery Modes	d. 5% Hybrid Incentive Boost
Gas Boiler (90-95% AFUE)5	RV7014	Efficient Products	HVAC	Utilities	Natural Gas	Down-stream	0.76	0.76	0.76	Median of all 11 values from literature	6. Similar Measures, All Delivery Modes	None
Gas Boiler (>95% AFUE)5	RV7015	Efficient Products	HVAC	Utilities	Natural Gas	Hybrid	0.80	0.80	0.80	Median of all 11 values from literature	6. Similar Measures, All Delivery Modes	d. 5% Hybrid Incentive Boost
Gas Boiler (>95% AFUE)5	RV7015	Efficient Products	HVAC	Utilities	Natural Gas	Down-stream	0.76	0.76	0.76	Median of all 11 values from literature	6. Similar Measures, All Delivery Modes	None
Gas Furnace - Tier 1 (>95%)5	RV7016	Efficient Products	HVAC	Utilities	Natural Gas	Hybrid	0.80	0.80	0.80	Median of all 11 values from literature	6. Similar Measures, All Delivery Modes	d. 5% Hybrid Incentive Boost
Gas Furnace - Tier 1 (>95%)5	RV7016	Efficient Products	HVAC	Utilities	Natural Gas	Down-stream	0.76	0.76	0.76	Median of all 11 values from literature	6. Similar Measures, All Delivery Modes	None
Gas Furnace - Tier 2 (>97%)5	RV7017	Efficient Products	HVAC	Utilities	Natural Gas	Hybrid	0.80	0.80	0.80	Median of all 11 values from literature	6. Similar Measures, All Delivery Modes	d. 5% Hybrid Incentive Boost
Gas Furnace - Tier 2 (>97%)5	RV7017	Efficient Products	HVAC	Utilities	Natural Gas	Down-stream	0.76	0.76	0.76	Median of all 11 values from literature	6. Similar Measures, All Delivery Modes	None
Gas Combi Heat Tier 1(AFUE >95%)	RV7018	Efficient Products	HVAC	Utilities	Natural Gas	Hybrid	0.80	0.80	0.80	Median of all 11 values from literature	6. Similar Measures, All Delivery Modes	d. 5% Hybrid Incentive Boost
Gas Combi Heat Tier 1(AFUE >95%)	RV7018	Efficient Products	HVAC	Utilities	Natural Gas	Down-stream	0.76	0.76	0.76	Median of all 11 values from literature	6. Similar Measures, All Delivery Modes	None

Measure	Unique ID #	Program	Measure Group	PA	Fuel Type	Delivery Mode	NTG 2024	NTG 2025	NTG 2026	NTG Basis	Method	Variation
Gas Combi Heat Tier 2(AFUE >97%)	RV7019	Efficient Products	HVAC	Utilities	Natural Gas	Hybrid	0.80	0.80	0.80	Median of all 11 values from literature	6. Similar Measures, All Delivery Modes	d. 5% Hybrid Incentive Boost
Gas Combi Heat Tier 2(AFUE >97%)	RV7019	Efficient Products	HVAC	Utilities	Natural Gas	Down-stream	0.76	0.76	0.76	Median of all 11 values from literature	6. Similar Measures, All Delivery Modes	None
Qualifying Gas Heat with qualifying Gas Water Heat <55gallons,UEF>.64	RV7020	Efficient Products	HVAC	Utilities	Natural Gas	Hybrid	0.80	0.80	0.80	Median of 11 values in literature for envelope insulation	8. Full Measure Group	d. 5% Hybrid Incentive Boost
Qualifying Gas Heat with qualifying Gas Water Heat <55gallons,UEF>.64	RV7020	Efficient Products	HVAC	Utilities	Natural Gas	Down-stream	0.76	0.76	0.76	Median of 11 gas heat and 6 gas waterheater values in literature	8. Full Measure Group	none
Qualifying Gas Heat with qualifying Gas Water Heat >55gallons,UEF>.64	RV7021	Efficient Products	HVAC	Utilities	Natural Gas	Hybrid	0.80	0.80	0.80	Median of 11 values in literature for envelope insulation	8. Full Measure Group	d. 5% Hybrid Incentive Boost
Qualifying Gas Heat with qualifying Gas Water Heat >55gallons,UEF>.64	RV7021	Efficient Products	HVAC	Utilities	Natural Gas	Down-stream	0.76	0.76	0.76	Median of 11 gas heat and 6 gas waterheater values in literature	8. Full Measure Group	none
Smart Thermostats - Gas Heat and no CAC or muni	RV7022	Efficient Products	HVAC	Utilities	Natural Gas	Hybrid	0.78	0.75	0.72	Median of 8 values from literature	6. Similar Measures, All Delivery Modes	d. 5% Boost for Hybrid Incentive; f. Annual Decrease (3 percentage points) Due to Moderate Commercialization
Smart Thermostats - Gas Heat and no CAC or muni	RV7022	Efficient Products	HVAC	Utilities	Natural Gas	Down-stream	0.74	0.71	0.68	Median of 8 values from literature	6. Similar Measures, All Delivery Modes	f. Annual Decrease (3 percentage points) Due to Moderate Commercialization

Measure	Unique ID #	Program	Measure Group	PA	Fuel Type	Delivery Mode	NTG 2024	NTG 2025	NTG 2026	NTG Basis	Method	Variation
Smart Thermostats - Gas Heat w/ CAC	RV7023	Efficient Products	HVAC	Utilities	Natural Gas	Hybrid	0.78	0.75	0.72	Median of 8 values from literature	6. Similar Measures, All Delivery Modes	d. 5% Boost for Hybrid Incentive; f. Annual Decrease (3 percentage points) Due to Moderate Commercialization
Smart Thermostats - Gas Heat w/ CAC	RV7023	Efficient Products	HVAC	Utilities	Electric	Hybrid	0.78	0.75	0.72	Median of 8 values from literature	6. Similar Measures, All Delivery Modes	d. 5% Boost for Hybrid Incentive; f. Annual Decrease (3 percentage points) Due to Moderate Commercialization
Smart Thermostats - Gas Heat w/ CAC	RV7023	Efficient Products	HVAC	Utilities	Natural Gas	Down-stream	0.74	0.71	0.68	Median of 8 values from literature	6. Similar Measures, All Delivery Modes	f. Annual Decrease (3 percentage points) Due to Moderate Commercialization
Smart Thermostats - Gas Heat w/ CAC	RV7023	Efficient Products	HVAC	Utilities	Electric	Down-stream	0.74	0.71	0.68	Median of 8 values from literature	6. Similar Measures, All Delivery Modes	f. Annual Decrease (3 percentage points) Due to Moderate Commercialization
Smart Thermostats - Electric A/C and Elec Heat	RV7024	Efficient Products	HVAC	Utilities	Electric	Hybrid	0.78	0.75	0.72	Median of 8 values from literature	6. Similar Measures, All Delivery Modes	d. 5% Boost for Hybrid Incentive; f. Annual Decrease (3 percentage points) Due to Moderate Commercialization
Smart Thermostats - Electric A/C and Elec Heat	RV7024	Efficient Products	HVAC	Utilities	Electric	Down-stream	0.74	0.71	0.68	Median of 8 values from literature	6. Similar Measures, All Delivery Modes	f. Annual Decrease (3 percentage points) Due to Moderate Commercialization
Smart Thermostat - Electric A/C and No Natural Gas	RV7025	Efficient Products	HVAC	Utilities	Electric	Hybrid	0.78	0.75	0.72	Median of 8 values from literature	6. Similar Measures, All Delivery Modes	d. 5% Boost for Hybrid Incentive; f. Annual Decrease (3 percentage points) Due to Moderate Commercialization
Smart Thermostat - Electric A/C and No Natural Gas	RV7025	Efficient Products	HVAC	Utilities	Electric	Down-stream	0.74	0.71	0.68	Median of 8 values from literature	6. Similar Measures, All Delivery Modes	f. Annual Decrease (3 percentage points) Due to Moderate Commercialization
Smart Thermostats - No Central A/C and Elec Heat	RV7026	Efficient Products	HVAC	Utilities	Electric	Hybrid	0.78	0.75	0.72	Median of 8 values from literature	6. Similar Measures, All Delivery Modes	d. 5% Boost for Hybrid Incentive; f. Annual Decrease (3 percentage points) Due to Moderate Commercialization

Measure	Unique ID #	Program	Measure Group	PA	Fuel Type	Delivery Mode	NTG 2024	NTG 2025	NTG 2026	NTG Basis	Method	Variation
Smart Thermostats - No Central A/C and Elec Heat	RV7026	Efficient Products	HVAC	Utilities	Electric	Down-stream	0.74	0.71	0.68	Median of 8 values from literature	6. Similar Measures, All Delivery Modes	f. Annual Decrease (3 percentage points) Due to Moderate Commercialization
HVAC Maintenance	RV7027	Efficient Products	HVAC	Utilities	Natural Gas	Hybrid	0.60	0.60	0.60	Median of 10 program-level values in literature	9. Program Level, Same Delivery Mode	none
HVAC Maintenance	RV7027	Efficient Products	HVAC	Utilities	Electric	Hybrid	0.60	0.60	0.60	Median of 10 program-level values in literature	9. Program Level, Same Delivery Mode	none
HVAC Maintenance	RV7027	Efficient Products	HVAC	Utilities	Natural Gas	Down-stream	0.60	0.60	0.60	Median of 10 program-level values in literature	9. Program Level, Same Delivery Mode	none
HVAC Maintenance	RV7027	Efficient Products	HVAC	Utilities	Electric	Down-stream	0.60	0.60	0.60	Median of 10 program-level values in literature	9. Program Level, Same Delivery Mode	none
HVAC Quality Install	RV7028	Efficient Products	HVAC	Utilities	Natural Gas	Hybrid	0.60	0.60	0.60	Median of 10 program-level values in literature	9. Program Level, Same Delivery Mode	none
HVAC Quality Install	RV7028	Efficient Products	HVAC	Utilities	Electric	Hybrid	0.60	0.60	0.60	Median of 10 program-level values in literature	9. Program Level, Same Delivery Mode	none
HVAC Quality Install	RV7028	Efficient Products	HVAC	Utilities	Natural Gas	Down-stream	0.60	0.60	0.60	Median of 10 program-level values in literature	9. Program Level, Same Delivery Mode	none
HVAC Quality Install	RV7028	Efficient Products	HVAC	Utilities	Electric	Down-stream	0.60	0.60	0.60	Median of 10 program-level	9. Program Level, Same Delivery Mode	none

Measure	Unique ID #	Program	Measure Group	PA	Fuel Type	Delivery Mode	NTG 2024	NTG 2025	NTG 2026	NTG Basis	Method	Variation
										values in literature		
Properly Maintained Boiler (note: discuss timing. Previously assumed these would kick off later)	RV7029	Efficient Products	HVAC	Utilities	Natural Gas	Down-stream	0.60	0.60	0.60	Median of 10 program-level values in literature	9. Program Level, Same Delivery Mode	none
Properly Maintained Furnace (note: discuss timing. Previously assumed these would kick off later)	RV7030	Efficient Products	HVAC	Utilities	Natural Gas	Down-stream	0.60	0.60	0.60	Median of 10 program-level values in literature	9. Program Level, Same Delivery Mode	none
Properly Maintained Furnace (note: discuss timing. Previously assumed these would kick off later)	RV7030	Efficient Products	HVAC	Utilities	Electric	Down-stream	0.60	0.60	0.60	Median of 10 program-level values in literature	9. Program Level, Same Delivery Mode	none
Quality Install	RV7031	Efficient Products	HVAC	Utilities	Natural Gas	Hybrid	0.60	0.60	0.60	Median of 10 program-level values in literature	9. Program Level, Same Delivery Mode	none
Quality Install	RV7031	Efficient Products	HVAC	Utilities	Electric	Hybrid	0.60	0.60	0.60	Median of 10 program-level values in literature	9. Program Level, Same Delivery Mode	none
Quality Install	RV7031	Efficient Products	HVAC	Utilities	Natural Gas	Down-stream	0.60	0.60	0.60	Median of 10 program-level values in literature	9. Program Level, Same Delivery Mode	none
Quality Install	RV7031	Efficient Products	HVAC	Utilities	Electric	Down-stream	0.60	0.60	0.60	Median of 10 program-level values in literature	9. Program Level, Same Delivery Mode	none

Measure	Unique ID #	Program	Measure Group	PA	Fuel Type	Delivery Mode	NTG 2024	NTG 2025	NTG 2026	NTG Basis	Method	Variation
All ducted and ductless air source heat pumps and HPWH - multifamily		Efficient Products	HVAC	Utilities	Electric	Downstream	0.93	0.93	0.93	Median of 2 MF values from literature	6. Similar Measures, All Delivery Modes	None
All non-heat pump HVAC/WH - multifamily		Efficient Products	HVAC	Utilities	Electric	Downstream	0.86	0.86	0.86	Median of 9 values from literature	6. Similar Measures, All Delivery Modes	none
EE Kits - Power strip included, no LEDs (other than nightlights)	RS13001	Efficient Products	Kits	Utilities	Electric	Online	0.90	0.90	0.90	Evaluator Assigned based on market data	10. Evaluator Assigned	I. Broad Market Trends
EE Kits - water conservation measures included, no power strip or LEDs (other than nightlights)	RS13001	Efficient Products	Kits	Utilities	Electric	Online	0.60	0.60	0.60	Median of 10 program-level values in literature	9. Program Level, Same Delivery Mode	none
EE Kits - LED light bulbs included (other than nightlights)	RS13001	Efficient Products	Kits	Utilities	Electric	Online	0.00	0.00	0.00	Federal or state standard	3. Federal or State Standard	None
LED Lamps163	RL1001	Efficient Products	Lighting	Utilities	Electric	Online	0.00	0.00	0.00	Federal or state standard	3. Federal or State Standard	None
LED Lamps164	RL1001	Efficient Products	Lighting	Utilities	Electric	Upstream	0.00	0.00	0.00	Federal or state standard	3. Federal or State Standard	None
LED Fixtures - retrofit kits and integrated luminaires	RL1002.1	Efficient Products	Lighting	Utilities	Electric	Online	0.00	0.00	0.00	Federal or state standard	3. Federal or State Standard	None

163 NTG Source: <https://njcleanenergy.com/files/file/Library/FY23/NJ%20Residential%20Lighting%20Sales%20and%20NTG%20Analysis%2020220707.pdf>

164 NTG Source: <https://njcleanenergy.com/files/file/Library/FY23/NJ%20Residential%20Lighting%20Sales%20and%20NTG%20Analysis%2020220707.pdf>

Measure	Unique ID #	Program	Measure Group	PA	Fuel Type	Delivery Mode	NTG 2024	NTG 2025	NTG 2026	NTG Basis	Method	Variation
LED Fixtures - retrofit kits and integrated luminaires	RL1002.1	Efficient Products	Lighting	Utilities	Electric	Upstream	0.00	0.00	0.00	Federal or state standard	3. Federal or State Standard	None
LED Fixtures - medium screw base165	RL1002.2	Efficient Products	Lighting	Utilities	Electric	Online	0.00	0.00	0.00	Federal or state standard	3. Federal or State Standard	None
LED Fixtures - medium screw base166	RL1002.2	Efficient Products	Lighting	Utilities	Electric	Upstream	0.00	0.00	0.00	Federal or state standard	3. Federal or State Standard	None
LED Table/Desk Lamps - integrated luminaires (otherwise see MSB)	RL1003	Efficient Products	Lighting	Utilities	Electric	Online	0.00	0.00	0.00	Federal or state standard	3. Federal or State Standard	None
LED Table/Desk Lamps - integrated luminaires (otherwise see MSB)	RL1003	Efficient Products	Lighting	Utilities	Electric	Upstream	0.00	0.00	0.00	Federal or state standard	3. Federal or State Standard	None
LED Holiday Lights	RL1004	Efficient Products	Lighting	Utilities	Electric	Online	0.45	0.40	0.35	Evaluator Assigned based on market data	10. Evaluator Assigned	g. Annual Decrease (5 percentage points) Due to Rapid Commercialization; k. National Shipment Data
LED Holiday Lights	RL1004	Efficient Products	Lighting	Utilities	Electric	Upstream	0.45	0.40	0.35	Evaluator Assigned based on market data	10. Evaluator Assigned	g. Annual Decrease (5 percentage points) Due to Rapid Commercialization; k. National Shipment Data
Ceiling Fans - integrated luminaire (otherwise see MSB)	RL1005	Efficient Products	Lighting	Utilities	Electric	Upstream	0.00	0.00	0.00	Federal or state standard	3. Federal or State Standard	None

165 NTG Source: <https://njcleanenergy.com/files/file/Library/FY23/NJ%20Residential%20Lighting%20Sales%20and%20NTG%20Analysis%2020220707.pdf>

¹⁶⁶ <https://njcleanenergy.com/files/file/Library/FY23/NJ%20Residential%20Lighting%20Sales%20and%20NTG%20Analysis%2020220707.pdf>

Measure	Unique ID #	Program	Measure Group	PA	Fuel Type	Delivery Mode	NTG 2024	NTG 2025	NTG 2026	NTG Basis	Method	Variation
Occupancy Sensors	RL1006	Efficient Products	Lighting	Utilities	Electric	Online	0.75	0.75	0.75	Evaluator Assigned based on market data	10. Evaluator Assigned	I. Broad Market Trends
Occupancy Sensors	RL1006	Efficient Products	Lighting	Utilities	Electric	Upstream	0.75	0.75	0.75	Evaluator Assigned based on market data	10. Evaluator Assigned	I. Broad Market Trends
Monitors	RO4001	Efficient Products	Office	Utilities	Electric	Down-stream	0.27	0.24	0.21	Evaluator Assigned based on market data	10. Evaluator Assigned	k. National Shipment Data
Monitors	RO4001	Efficient Products	Office	Utilities	Electric	Upstream	0.27	0.24	0.21	Evaluator Assigned based on market data	10. Evaluator Assigned	k. National Shipment Data
Computers	RO4002	Efficient Products	Office	Utilities	Electric	Down-stream	0.27	0.24	0.21	Evaluator Assigned based on market data	10. Evaluator Assigned	k. National Shipment Data
Computers	RO4002	Efficient Products	Office	Utilities	Electric	Upstream	0.27	0.24	0.21	Evaluator Assigned based on market data	10. Evaluator Assigned	k. National Shipment Data
Imaging	RO4003	Efficient Products	Office	Utilities	Electric	Down-stream	0.27	0.24	0.21	Evaluator Assigned based on market data	10. Evaluator Assigned	k. National Shipment Data
Imaging	RO4003	Efficient Products	Office	Utilities	Electric	Upstream	0.27	0.24	0.21	Evaluator Assigned based on market data	10. Evaluator Assigned	k. National Shipment Data
TVs	RO4004	Efficient Products	Office	Utilities	Electric	Down-stream	0.83	0.83	0.83	Median of 2 values from literature	5. Similar Measures, Delivery Mode	None
TVs	RO4004	Efficient Products	Office	Utilities	Electric	Upstream	0.83	0.83	0.83	Median of 2 values from literature	5. Similar Measures, Delivery Mode	None
Smart Strip Plug Outlets - Tier 1	RP5001	Efficient Products	Plug Loads	Utilities	Electric	Online	0.90	0.90	0.90	Evaluator Assigned based on market data	10. Evaluator Assigned	I. Broad Market Trends

Measure	Unique ID #	Program	Measure Group	PA	Fuel Type	Delivery Mode	NTG 2024	NTG 2025	NTG 2026	NTG Basis	Method	Variation
Smart Strip Plug Outlets - Tier 1	RP5001	Efficient Products	Plug Loads	Utilities	Electric	Upstream	0.90	0.90	0.90	Evaluator Assigned based on market data	10. Evaluator Assigned	I. Broad Market Trends
Smart Strip Plug Outlets - Tier 2	RP5002	Efficient Products	Plug Loads	Utilities	Electric	Online	0.90	0.90	0.90	Evaluator Assigned based on market data	10. Evaluator Assigned	I. Broad Market Trends
Smart Strip Plug Outlets - Tier 2	RP5002	Efficient Products	Plug Loads	Utilities	Electric	Upstream	0.90	0.90	0.90	Evaluator Assigned based on market data	10. Evaluator Assigned	I. Broad Market Trends
Smart Home	RP5003	Efficient Products	Plug Loads	Utilities	Electric	Online	0.75	0.75	0.75	Evaluator Assigned based on market data	10. Evaluator Assigned	I. Broad Market Trends
Low flow Showerhead - not TSV	RA2025	Efficient Products	Waterheating	Utilities	Natural Gas	Online	0.60	0.60	0.60	Median of 10 program-level values in literature	9. Program Level, Same Delivery Mode	none
Low flow Showerhead - not TSV	RA2025	Efficient Products	Waterheating	Utilities	Electric	Online	0.60	0.60	0.60	Median of 10 program-level values in literature	9. Program Level, Same Delivery Mode	none
Faucet Aerator	RA2026	Efficient Products	Waterheating	Utilities	Natural Gas	Online	0.60	0.60	0.60	Median of 10 program-level values in literature	9. Program Level, Same Delivery Mode	none
Faucet Aerator	RA2026	Efficient Products	Waterheating	Utilities	Electric	Online	0.60	0.60	0.60	Median of 10 program-level values in literature	9. Program Level, Same Delivery Mode	none
Pipe Insulation	RA2027	Efficient Products	Waterheating	Utilities	Natural Gas	Down-stream	0.60	0.60	0.60	Median of 10 program-level values in literature	9. Program Level, Same Delivery Mode	none

Measure	Unique ID #	Program	Measure Group	PA	Fuel Type	Delivery Mode	NTG 2024	NTG 2025	NTG 2026	NTG Basis	Method	Variation
Pipe Insulation	RA2027	Efficient Products	Waterheating	Utilities	Electric	Down-stream	0.60	0.60	0.60	Median of 10 program-level values in literature	9. Program Level, Same Delivery Mode	none
Smart waterheater controller	RNMR-1	Efficient Products	Waterheating	Rockland Electric	Natural Gas	Online	0.75	0.75	0.75	Evaluator Assigned based on market data	10. Evaluator Assigned	I. Broad Market Trends
Heat Pump waterheater	RW3001	Efficient Products	Waterheating	Utilities	Electric	Down-stream	0.78	0.78	0.78	Median of 2 values from literature	4. Multiple Directly Comparable Sources	None
Heat Pump waterheater	RW3001	Efficient Products	Waterheating	Utilities	Electric	Upstream	0.78	0.78	0.78	Median of 2 values from literature	4. Multiple Directly Comparable Sources	None
Gas Storage Tank waterheater - Power Vented <55 gallons, UEF>.64 Medium Draw Pattern UEF ≥ 0.64 High Draw Pattern UEF ≥ 0.68	RW3002	Efficient Products	Waterheating	Utilities	Natural Gas	Down-stream	0.76	0.76	0.76	Median of 6 value from literature	6. Similar Measures, All Delivery Modes	None
Gas Storage Tank waterheater - Power Vented <55 gallons, UEF>.64 Medium Draw Pattern UEF ≥ 0.64 High Draw Pattern UEF ≥ 0.68	RW3002	Efficient Products	Waterheating	Utilities	Natural Gas	Upstream	0.76	0.76	0.76	Median of 6 value from literature	6. Similar Measures, All Delivery Modes	None
Gas Storage Tank waterheater - Power Vented >55 gallons, UEF>.85 Medium Draw Pattern UEF ≥ 0.78	RW3003	Efficient Products	Waterheating	Utilities	Natural Gas	Down-stream	0.76	0.76	0.76	Median of 6 value from literature	6. Similar Measures, All Delivery Modes	None

Measure	Unique ID #	Program	Measure Group	PA	Fuel Type	Delivery Mode	NTG 2024	NTG 2025	NTG 2026	NTG Basis	Method	Variation
High Draw Pattern UEF ≥ 0.80												
Gas Storage Tank waterheater - Power Vented >55 gallons, UEF>.85 Medium Draw Pattern UEF ≥ 0.78 High Draw Pattern UEF ≥ 0.80	RW3003	Efficient Products	Waterheating	Utilities	Natural Gas	Upstream	0.76	0.76	0.76	Median of 6 value from literature	6. Similar Measures, All Delivery Modes	None
Tankless WH, UEF>=0.87	RW3004	Efficient Products	Waterheating	Utilities	Natural Gas	Down-stream	0.76	0.76	0.76	Median of 6 value from literature	6. Similar Measures, All Delivery Modes	None
Tankless WH, UEF>=0.87	RW3004	Efficient Products	Waterheating	Utilities	Natural Gas	Upstream	0.76	0.76	0.76	Median of 6 value from literature	6. Similar Measures, All Delivery Modes	None
Indirect - Fired Storage Tank waterheater* (must be attached to Energy Star rated heating Source)	RW3005	Efficient Products	Waterheating	Utilities	Natural Gas	Down-stream	0.76	0.76	0.76	Median of 11 gas heat and 6 gas waterheater values in literature	8. Full Measure Group	none
Indirect - Fired Storage Tank waterheater* (must be attached to Energy Star rated heating Source)	RW3005	Efficient Products	Waterheating	Utilities	Natural Gas	Upstream	0.76	0.76	0.76	Median of 11 gas heat and 6 gas waterheater values in literature	8. Full Measure Group	none
QHEC- PIPE INSULATION	RQ10007	QHEC	Waterheating	Utilities	Natural Gas	Direct Install	0.60	0.60	0.60	Median of 10 program-level values in literature	9. Program Level, Same Delivery Mode	none
Refrigerator Replacement for MIW	RM11065	Moderate Income Weatherization	Appliances	Utilities	Electric	Direct Install	0.52	0.52	0.52	Median of 6 values from literature	4. Multiple Directly Comparable Sources	a. Removed Outliers; c. 10% Moderate Income Boost

Measure	Unique ID #	Program	Measure Group	PA	Fuel Type	Delivery Mode	NTG 2024	NTG 2025	NTG 2026	NTG Basis	Method	Variation
Behavioral Programs - Opt-out Home Energy Report / Randomized Control Design	RNMR-2	Existing Homes	Behavioral	Utilities	Electric	Direct Install	1.00	1.00	1.00	Randomized Control Design	2. Randomized Control Design	None
Behavioral Programs - Virtual Audit	RNMR-2.1	Existing Homes	Behavioral	Utilities	Electric	Direct Install	0.75	0.75	0.75	Evaluator Assigned based on market data	10. Evaluator Assigned	I. Broad Market Trends
Behavioral Programs - Other	RNMR-2.2	Existing Homes	Behavioral	Utilities	Electric	Direct Install	0.75	0.75	0.75	Evaluator Assigned based on market data	10. Evaluator Assigned	I. Broad Market Trends
Behavioral Programs - Opt-out Home Energy Report / Randomized Control Design	RNMR-3	Existing Homes	Behavioral	Utilities	Natural Gas	Direct Install	1.00	1.00	1.00	Randomized Control Design	2. Randomized Control Design	None
Behavioral Programs - Virtual Audit	RNMR-3.1	Existing Homes	Behavioral	Utilities	Natural Gas	Direct Install	0.75	0.75	0.75	Evaluator Assigned based on market data	10. Evaluator Assigned	I. Broad Market Trends
Behavioral Programs - Other	RNMR-3.2	Existing Homes	Behavioral	Utilities	Natural Gas	Direct Install	0.75	0.75	0.75	Evaluator Assigned based on market data	10. Evaluator Assigned	I. Broad Market Trends
Contractor Incentive	RH9001	Home Performance	Contractor Incentive	Utilities	Electric	Midstream	0.00	0.00	0.00	Evaluator Assigned based on market data	10. Evaluator Assigned	I. Broad Market Trends
Contractor Incentive	RH9001	Home Performance	Contractor Incentive	Utilities	Natural Gas	Midstream	0.00	0.00	0.00	Evaluator Assigned based on market data	10. Evaluator Assigned	I. Broad Market Trends
Exhaust Ventilation Fans	RH9010	Home Performance	Fans & Pumps	Utilities	Electric	Direct Install	0.60	0.60	0.60	Median of 10 program-level values in literature	9. Program Level, Same Delivery Mode	none

Measure	Unique ID #	Program	Measure Group	PA	Fuel Type	Delivery Mode	NTG 2024	NTG 2025	NTG 2026	NTG Basis	Method	Variation
Furnace Fans (ECM motor install)	RH9021	Home Performance	Fans & Pumps	Utilities	Electric	Direct Install	0.63	0.63	0.63	Median of 3 values from literature	5. Similar Measures, Delivery Mode	None
Circulating Pump	RH9024	Home Performance	Fans & Pumps	Utilities	Electric	Direct Install	0.76	0.76	0.76	Median of 3 values from literature	6. Similar Measures, All Delivery Modes	None
Exhaust Ventilation Fans	RM11009	Moderate Income Weatherization	Fans & Pumps	Utilities	Electric	Direct Install	0.66	0.66	0.66	Median of 10 program-level values in literature	9. Program Level, Same Delivery Mode	c. 10% Moderate Income Boost
Furnace Fans (ECM motor install)	RM11020	Moderate Income Weatherization	Fans & Pumps	Utilities	Electric	Direct Install	0.69	0.69	0.69	Median of 3 values from literature	6. Similar Measures, All Delivery Modes	c. 10% Moderate Income Boost
Circulating Pump	RM11023	Moderate Income Weatherization	Fans & Pumps	Utilities	Electric	Direct Install	0.84	0.84	0.84	Median of 3 values from literature	6. Similar Measures, All Delivery Modes	c. 10% Moderate Income Boost
Smart Thermostat	RH9008	Home Performance	HVAC	Utilities	Electric	Direct Install	0.74	0.71	0.68	Median of 8 values from literature	6. Similar Measures, All Delivery Modes	f. Annual Decrease (3 percentage points) Due to Moderate Commercialization
Smart Thermostat	RH9008	Home Performance	HVAC	Utilities	Natural Gas	Direct Install	0.74	0.71	0.68	Median of 8 values from literature	6. Similar Measures, All Delivery Modes	f. Annual Decrease (3 percentage points) Due to Moderate Commercialization
Heat/Energy Recovery Ventilator	RH9011	Home Performance	HVAC	Utilities	Electric	Direct Install	0.75	0.75	0.75	Evaluator Assigned based on market data	10. Evaluator Assigned	I. Broad Market Trends
Central Air Conditioning Tier 1 (SEER >=16, EER >=12.5)	RH9012	Home Performance	HVAC	Utilities	Electric	Direct Install	0.74	0.74	0.74	Median of 7 values from literature	5. Similar Measures, Delivery Mode	None
Central Air Conditioning Tier 2 (SEER >=18, EER >=13)	RH9013	Home Performance	HVAC	Utilities	Electric	Direct Install	0.74	0.74	0.74	Median of 7 values from literature	5. Similar Measures, Delivery Mode	None

Measure	Unique ID #	Program	Measure Group	PA	Fuel Type	Delivery Mode	NTG 2024	NTG 2025	NTG 2026	NTG Basis	Method	Variation
Air Source Heat Pump Tier 1 (SEER >=16, EER >=12.5 HSPF >=9)	RH9014	Home Performance	HVAC	Utilities	Electric	Direct Install	0.65	0.62	0.59	Median of 14 values from literature (excluding single value reserved for fuel switching)	6. Similar Measures, All Delivery Modes	f. Annual Decrease (3 percentage points) Due to Moderate Commercialization
Air Source Heat Pump Tier 2 (SEER >=18, EER >=13, HSPF >=10)	RH9015	Home Performance	HVAC	Utilities	Electric	Direct Install	0.71	0.68	0.65	Median of 15 values from literature (including single value reserved for fuel switching)	6. Similar Measures, All Delivery Modes	f. Annual Decrease (3 percentage points) Due to Moderate Commercialization
Air Source Heat Pump - Cold Climate (SEER >=18, EER >=12, HSPF >=10, and COP >=1.75 at 5 def F)	RH9016	Home Performance	HVAC	Utilities	Electric	Direct Install	0.78	0.75	0.72	Median of 15 values from literature (including single value reserved for fuel switching)	6. Similar Measures, All Delivery Modes	e. 10% Cold Climate Boost; f. Annual Decrease (3 percentage points) Due to Moderate Commercialization
Air Source Heat Pump - Cold Climate (SEER >=18, EER >=12, HSPF >=10, and COP >=1.75 at 5 def F)	RH9016	Home Performance	HVAC	Utilities	Electric	Direct Install	0.72	0.69	0.66	Median of 14 values from literature (excluding single value reserved for fuel switching)	6. Similar Measures, All Delivery Modes	e. 10% Cold Climate Boost; f. Annual Decrease (3 percentage points) Due to Moderate Commercialization
Air to Water Heat Pump (COP >1.75 at full load capacity and 110 deg F water temp)	RH9017	Home Performance	HVAC	Utilities	Electric	Direct Install	0.78	0.78	0.78	Median of 2 values from literature	6. Similar Measures, All Delivery Modes	None
Geothermal Heat Pump Energy Star Closed Loop Wtr to Air EER >= 17.1 Closed Loop Wtr to Wtr EER >= 21.1	RH9018	Home Performance	HVAC	Utilities	Electric	Direct Install	0.67	0.67	0.67	Evaluator Assigned based on market data	10. Evaluator Assigned	I. Broad Market Trends

Measure	Unique ID #	Program	Measure Group	PA	Fuel Type	Delivery Mode	NTG 2024	NTG 2025	NTG 2026	NTG Basis	Method	Variation
Open Loop Wtr to Air EER >= 16.1 Open Loop Wtr to Wtr EER >= 20.1												
Ductless Mini-Split Heat Pump Multi (SEER >= 18, EER >=12.5 or HSPF >= 10) Single (SEER >= 20, EER >=12.5 or HSPF >= 10)	RH9019	Home Performance	HVAC	Utilities	Electric	Direct Install	0.71	0.68	0.65	Median of 15 values from literature (including single value reserved for fuel switching)	6. Similar Measures, All Delivery Modes	f. Annual Decrease (3 percentage points) Due to Moderate Commercialization
Ductless Mini Split A/C (SEER >= 20, EER >=12)	RH9020	Home Performance	HVAC	Utilities	Electric	Direct Install	0.65	0.62	0.59	Median of 14 values from literature (excluding single value reserved for fuel switching)	6. Similar Measures, All Delivery Modes	f. Annual Decrease (3 percentage points) Due to Moderate Commercialization
PTAC - CEE Tier 2 - Multi Family	RH9022	Home Performance	HVAC	Utilities	Electric	Direct Install	0.93	0.93	0.93	Median of 2 MF values from literature	6. Similar Measures, All Delivery Modes	None
PTHP - CEE Tier 2- Multi Family	RH9023	Home Performance	HVAC	Utilities	Electric	Direct Install	0.93	0.93	0.93	Median of 2 MF values from literature	6. Similar Measures, All Delivery Modes	None
Reset controls for boiler	RH9025	Home Performance	HVAC	Utilities	Natural Gas	Direct Install	0.75	0.75	0.75	Evaluator Assigned based on market data	10. Evaluator Assigned	I. Broad Market Trends
Gas Boiler (90-95% AFUE)5	RH9026	Home Performance	HVAC	Utilities	Natural Gas	Direct Install	0.76	0.76	0.76	Median of all 11 values from literature	6. Similar Measures, All Delivery Modes	none
Gas Boiler (>95% AFUE)5	RH9027	Home Performance	HVAC	Utilities	Natural Gas	Direct Install	0.76	0.76	0.76	Median of all 11 values from literature	6. Similar Measures, All Delivery Modes	none

Measure	Unique ID #	Program	Measure Group	PA	Fuel Type	Delivery Mode	NTG 2024	NTG 2025	NTG 2026	NTG Basis	Method	Variation
Gas Furnace - Tier 1 (>95%)5	RH9028	Home Performance	HVAC	Utilities	Natural Gas	Direct Install	0.76	0.76	0.76	Median of all 11 values from literature	6. Similar Measures, All Delivery Modes	none
Gas Furnace - Tier 2 (>97%)5	RH9029	Home Performance	HVAC	Utilities	Natural Gas	Direct Install	0.76	0.76	0.76	Median of all 11 values from literature	6. Similar Measures, All Delivery Modes	none
Gas Combi Heat Tier 1(AFUE >95%)	RH9030	Home Performance	HVAC	Utilities	Natural Gas	Direct Install	0.76	0.76	0.76	Median of all 11 values from literature	6. Similar Measures, All Delivery Modes	none
Gas Combi Heat Tier 2(AFUE >97%)	RH9031	Home Performance	HVAC	Utilities	Natural Gas	Direct Install	0.76	0.76	0.76	Median of all 11 values from literature	6. Similar Measures, All Delivery Modes	none
Quality Install	RH9034	Home Performance	HVAC	Utilities	Natural Gas	Direct Install	0.60	0.60	0.60	Median of 10 program-level values in literature	9. Program Level, Same Delivery Mode	none
Quality Install	RH9034	Home Performance	HVAC	Utilities	Electric	Direct Install	0.60	0.60	0.60	Median of 10 program-level values in literature	9. Program Level, Same Delivery Mode	none
Properly Maintained Boiler (note: discuss timing. Previously assumed these would kick off later)	RH9039	Home Performance	HVAC	Utilities	Natural Gas	?	0.60	0.60	0.60	Median of 10 program-level values in literature	9. Program Level, Same Delivery Mode	none
Properly Maintained Furnace (note: discuss timing. Previously assumed these would kick off later)	RH9040	Home Performance	HVAC	Utilities	Natural Gas	?	0.60	0.60	0.60	Median of 10 program-level values in literature	9. Program Level, Same Delivery Mode	none
Properly Maintained Furnace (note: discuss timing.	RH9040	Home Performance	HVAC	Utilities	Electric	?	0.60	0.60	0.60	Median of 10 program-level	9. Program Level, Same Delivery Mode	none

Measure	Unique ID #	Program	Measure Group	PA	Fuel Type	Delivery Mode	NTG 2024	NTG 2025	NTG 2026	NTG Basis	Method	Variation
Previously assumed these would kick off later)										values in literature		
HVAC Tune-up for AC	RH9041	Home Performance	HVAC	Utilities	Electric	Direct Install	0.60	0.60	0.60	Median of 10 program-level values in literature	9. Program Level, Same Delivery Mode	none
Smart Thermostats - Gas Heat and no CAC or muni	RH9042	Home Performance	HVAC	Utilities	Natural Gas	Direct Install	0.74	0.71	0.68	Median of 8 values from literature	6. Similar Measures, All Delivery Modes	f. Annual Decrease (3 percentage points) Due to Moderate Commercialization
Smart Thermostats - Gas Heat w/ CAC	RH9043	Home Performance	HVAC	Utilities	Natural Gas	Direct Install	0.74	0.71	0.68	Median of 8 values from literature	6. Similar Measures, All Delivery Modes	f. Annual Decrease (3 percentage points) Due to Moderate Commercialization
Smart Thermostats - Gas Heat w/ CAC	RH9043	Home Performance	HVAC	Utilities	Electric	Direct Install	0.74	0.71	0.68	Median of 8 values from literature	6. Similar Measures, All Delivery Modes	f. Annual Decrease (3 percentage points) Due to Moderate Commercialization
Smart Thermostats - Electric A/C and Elec Heat	RH9044	Home Performance	HVAC	Utilities	Electric	Direct Install	0.74	0.71	0.68	Median of 8 values from literature	6. Similar Measures, All Delivery Modes	f. Annual Decrease (3 percentage points) Due to Moderate Commercialization
Smart Thermostat - Electric A/C and No Natural Gas	RH9045	Home Performance	HVAC	Utilities	Electric	Direct Install	0.74	0.71	0.68	Median of 8 values from literature	6. Similar Measures, All Delivery Modes	f. Annual Decrease (3 percentage points) Due to Moderate Commercialization
Smart Thermostats - No Central A/C and Elec Heat	RH9046	Home Performance	HVAC	Utilities	Electric	Direct Install	0.74	0.71	0.68	Median of 8 values from literature	6. Similar Measures, All Delivery Modes	f. Annual Decrease (3 percentage points) Due to Moderate Commercialization
Smart Thermostat	RM11007	Moderate Income Weatherization	HVAC	Utilities	Electric	Direct Install	0.82	0.79	0.76	Median of 8 values from literature	6. Similar Measures, All Delivery Modes	c. 10% Moderate Income Boost; f. Annual Decrease (3 percentage points) Due to Moderate Commercialization
Smart Thermostat	RM11007	Moderate Income Weatherization	HVAC	Utilities	Natural Gas	Direct Install	0.82	0.79	0.76	Median of 8 values from literature	6. Similar Measures, All Delivery Modes	c. 10% Moderate Income Boost; f. Annual Decrease (3 percentage points) Due to Moderate Commercialization

Measure	Unique ID #	Program	Measure Group	PA	Fuel Type	Delivery Mode	NTG 2024	NTG 2025	NTG 2026	NTG Basis	Method	Variation
Heat/Energy Recovery Ventilator	RM11010	Moderate Income Weatherization	HVAC	Utilities	Electric	Direct Install	0.85	0.85	0.85	Evaluator Assigned based on market data	10. Evaluator Assigned	I. Broad Market Trends
Central Air Conditioning Tier 1 (SEER >=16, EER >=12.5)	RM11011	Moderate Income Weatherization	HVAC	Utilities	Electric	Direct Install	0.81	0.81	0.81	Median of 7 values from literature	6. Similar Measures, All Delivery Modes	c. 10% Moderate Income Boost
Central Air Conditioning Tier 2 (SEER >=18, EER >=13)	RM11012	Moderate Income Weatherization	HVAC	Utilities	Electric	Direct Install	0.81	0.81	0.81	Median of 7 values from literature	6. Similar Measures, All Delivery Modes	c. 10% Moderate Income Boost
Air Source Heat Pump Tier 1 (SEER >=16, EER >=12.5, HSPF >=9)	RM11013	Moderate Income Weatherization	HVAC	Utilities	Electric	Direct Install	0.72	0.69	0.66	Median of 14 values from literature (excluding single value reserved for fuel switching)	6. Similar Measures, All Delivery Modes	c. 10% Moderate Income Boost; f. Annual Decrease (3 percentage points) Due to Moderate Commercialization
Air Source Heat Pump Tier 2 (SEER >=18, EER >=13, HSPF >=10)	RM11014	Moderate Income Weatherization	HVAC	Utilities	Electric	Direct Install	0.78	0.75	0.72	Median of 15 values from literature (including single value reserved for fuel switching)	6. Similar Measures, All Delivery Modes	c. 10% Moderate Income Boost; f. Annual Decrease (3 percentage points) Due to Moderate Commercialization
Air Source Heat Pump - Cold Climate (SEER >=18, EER >=12, HSPF >=10, and COP >=1.75 at 5 def F)	RM11015	Moderate Income Weatherization	HVAC	Utilities	Electric	Direct Install	0.86	0.83	0.80	Median of 15 values from literature (including single value reserved for fuel switching)	6. Similar Measures, All Delivery Modes	c. 10% Moderate Income Boost; e. 10% Cold Climate Boost; f. Annual Decrease (3 percentage points) Due to Moderate Commercialization
Air Source Heat Pump - Cold Climate (SEER >=18, EER >=12, HSPF >=10, and COP >=1.75 at 5 def F)	RM11015	Moderate Income Weatherization	HVAC	Utilities	Electric	Direct Install	0.79	0.76	0.73	Median of 14 values from literature (excluding single value reserved for fuel switching)	6. Similar Measures, All Delivery Modes	c. 10% Moderate Income Boost; e. 10% Cold Climate Boost; f. Annual Decrease (3 percentage points) Due to Moderate Commercialization

Measure	Unique ID #	Program	Measure Group	PA	Fuel Type	Delivery Mode	NTG 2024	NTG 2025	NTG 2026	NTG Basis	Method	Variation
Air to Water Heat Pump (COP >1.75 at full load capacity and 110 deg F water temp)	RM11016	Moderate Income Weatherization	HVAC	Utilities	Electric	Direct Install	0.86	0.86	0.86	Median of 2 values from literature	6. Similar Measures, All Delivery Modes	c. 10% Moderate Income Boost
Geothermal Heat Pump Energy Star Closed Loop Wtr to Air EER >= 17.1 Closed Loop Wtr to Wtr EER >= 21.1 Open Loop Wtr to Air EER >= 16.1 Open Loop Wtr to Wtr EER >= 20.1	RM11017	Moderate Income Weatherization	HVAC	Utilities	Electric	Direct Install	0.77	0.77	0.77	Evaluator Assigned based on market data	10. Evaluator Assigned	I. Broad Market Trends
Ductless Mini-Split Heat Pump Multi (SEER >= 18, EER >=12.5 or HSPF >= 10) Single (SEER >= 20, EER >=12.5 or HSPF >= 10)	RM11018	Moderate Income Weatherization	HVAC	Utilities	Electric	Direct Install	0.78	0.75	0.72	Median of 15 values from literature (including single value reserved for fuel switching)	6. Similar Measures, All Delivery Modes	c. 10% Moderate Income Boost; f. Annual Decrease (3 percentage points) Due to Moderate Commercialization
Ductless Mini Split A/C (SEER >= 20, EER >=12)	RM11019	Moderate Income Weatherization	HVAC	Utilities	Electric	Direct Install	0.72	0.69	0.66	Median of 14 values from literature (excluding single value reserved for fuel switching)	6. Similar Measures, All Delivery Modes	c. 10% Moderate Income Boost; f. Annual Decrease (3 percentage points) Due to Moderate Commercialization
PTAC - CEE Tier 2 - Multi Family	RM11021	Moderate Income Weatherization	HVAC	Utilities	Electric	Direct Install	0.93	0.93	0.93	Median of 2 MF values from literature	6. Similar Measures, All Delivery Modes	None
PTHP - CEE Tier 2 - Multi Family	RM11022	Moderate Income Weatherization	HVAC	Utilities	Electric	Direct Install	0.93	0.93	0.93	Median of 2 MF values from literature	6. Similar Measures, All Delivery Modes	None

Measure	Unique ID #	Program	Measure Group	PA	Fuel Type	Delivery Mode	NTG 2024	NTG 2025	NTG 2026	NTG Basis	Method	Variation
Reset controls for boiler	RM11024	Moderate Income Weatherization	HVAC	Utilities	Natural Gas	Direct Install	0.85	0.85	0.85	Evaluator Assigned based on market data	10. Evaluator Assigned	I. Broad Market Trends
Gas Boiler (90-95% AFUE)5	RM11025	Moderate Income Weatherization	HVAC	Utilities	Natural Gas	Direct Install	0.84	0.84	0.84	Median of all 11 values from literature	6. Similar Measures, All Delivery Modes	c. 10% Moderate Income Boost
Gas Boiler (>95% AFUE)5	RM11026	Moderate Income Weatherization	HVAC	Utilities	Natural Gas	Direct Install	0.84	0.84	0.84	Median of all 11 values from literature	6. Similar Measures, All Delivery Modes	c. 10% Moderate Income Boost
Gas Furnace - Tier 1 (>95%)5	RM11027	Moderate Income Weatherization	HVAC	Utilities	Natural Gas	Direct Install	0.84	0.84	0.84	Median of all 11 values from literature	6. Similar Measures, All Delivery Modes	c. 10% Moderate Income Boost
Gas Furnace - Tier 2 (>97%)5	RM11028	Moderate Income Weatherization	HVAC	Utilities	Natural Gas	Direct Install	0.84	0.84	0.84	Median of all 11 values from literature	6. Similar Measures, All Delivery Modes	c. 10% Moderate Income Boost
Gas Combi Heat Tier 1(AFUE >95%)	RM11029	Moderate Income Weatherization	HVAC	Utilities	Natural Gas	Direct Install	0.84	0.84	0.84	Median of all 11 values from literature	6. Similar Measures, All Delivery Modes	c. 10% Moderate Income Boost
Gas Combi Heat Tier 2(AFUE >97%)	RM11030	Moderate Income Weatherization	HVAC	Utilities	Natural Gas	Direct Install	0.84	0.84	0.84	Median of all 11 values from literature	6. Similar Measures, All Delivery Modes	c. 10% Moderate Income Boost
Quality Install	RM11033	Moderate Income Weatherization	HVAC	Utilities	Natural Gas	Direct Install	0.66	0.66	0.66	Median of 10 program-level values in literature	9. Program Level, Same Delivery Mode	c. 10% Moderate Income Boost
Quality Install	RM11033	Moderate Income Weatherization	HVAC	Utilities	Electric	Direct Install	0.66	0.66	0.66	Median of 10 program-level values in literature	9. Program Level, Same Delivery Mode	c. 10% Moderate Income Boost
Properly Maintained Boiler (note: discuss timing. Previously	RM11038	Moderate Income Weatherization	HVAC	Utilities	Natural Gas	?	0.66	0.66	0.66	Median of 10 program-level values in literature	9. Program Level, Same Delivery Mode	c. 10% Moderate Income Boost

Measure	Unique ID #	Program	Measure Group	PA	Fuel Type	Delivery Mode	NTG 2024	NTG 2025	NTG 2026	NTG Basis	Method	Variation
assumed these would kick off later)												
Properly Maintained Furnace (note: discuss timing. Previously assumed these would kick off later)	RM11039	Moderate Income Weatherization	HVAC	Utilities	Natural Gas	?	0.66	0.66	0.66	Median of 10 program-level values in literature	9. Program Level, Same Delivery Mode	c. 10% Moderate Income Boost
Properly Maintained Furnace (note: discuss timing. Previously assumed these would kick off later)	RM11039	Moderate Income Weatherization	HVAC	Utilities	Electric	?	0.66	0.66	0.66	Median of 10 program-level values in literature	9. Program Level, Same Delivery Mode	c. 10% Moderate Income Boost
HVAC Tune-up for AC	RM11040	Moderate Income Weatherization	HVAC	Utilities	Electric	Direct Install	0.66	0.66	0.66	Median of 10 program-level values in literature	9. Program Level, Same Delivery Mode	c. 10% Moderate Income Boost
Smart Thermostats - Gas Heat and no CAC or muni	RM11048	Moderate Income Weatherization	HVAC	Utilities	Natural Gas	Direct Install	0.82	0.79	0.76	Median of 8 values from literature	6. Similar Measures, All Delivery Modes	c. 10% Moderate Income Boost; f. Annual Decrease (3 percentage points) Due to Moderate Commercialization
Smart Thermostats - Gas Heat w/ CAC	RM11049	Moderate Income Weatherization	HVAC	Utilities	Electric	Direct Install	0.82	0.79	0.76	Median of 8 values from literature	6. Similar Measures, All Delivery Modes	c. 10% Moderate Income Boost; f. Annual Decrease (3 percentage points) Due to Moderate Commercialization
Smart Thermostats - Gas Heat w/ CAC	RM11049	Moderate Income Weatherization	HVAC	Utilities	Natural Gas	Direct Install	0.82	0.79	0.76	Median of 8 values from literature	6. Similar Measures, All Delivery Modes	c. 10% Moderate Income Boost; f. Annual Decrease (3 percentage points) Due to Moderate Commercialization
Smart Thermostats - Electric A/C and Elec Heat	RM11050	Moderate Income Weatherization	HVAC	Utilities	Electric	Direct Install	0.82	0.79	0.76	Median of 8 values from literature	6. Similar Measures, All Delivery Modes	c. 10% Moderate Income Boost; f. Annual Decrease (3 percentage points) Due to Moderate Commercialization

Measure	Unique ID #	Program	Measure Group	PA	Fuel Type	Delivery Mode	NTG 2024	NTG 2025	NTG 2026	NTG Basis	Method	Variation
Smart Thermostat - Electric A/C and No Natural Gas	RM11051	Moderate Income Weatherization	HVAC	Utilities	Electric	Direct Install	0.82	0.79	0.76	Median of 8 values from literature	6. Similar Measures, All Delivery Modes	c. 10% Moderate Income Boost; f. Annual Decrease (3 percentage points) Due to Moderate Commercialization
Smart Thermostats - No Central A/C and Elec Heat	RM11052	Moderate Income Weatherization	HVAC	Utilities	Electric	Direct Install	0.82	0.79	0.76	Median of 8 values from literature	6. Similar Measures, All Delivery Modes	c. 10% Moderate Income Boost; f. Annual Decrease (3 percentage points) Due to Moderate Commercialization
Smart Thermostats - Gas Heat and no CAC or muni	RQ10008	QHEC	HVAC	Utilities	Natural Gas	Direct Install	0.74	0.71	0.68	Median of 8 values from literature	6. Similar Measures, All Delivery Modes	f. Annual Decrease (3 percentage points) Due to Moderate Commercialization
Smart Thermostats - Gas Heat w/ CAC	RQ10009	QHEC	HVAC	Utilities	Natural Gas	Direct Install	0.74	0.71	0.68	Median of 8 values from literature	6. Similar Measures, All Delivery Modes	f. Annual Decrease (3 percentage points) Due to Moderate Commercialization
Smart Thermostats - Gas Heat w/ CAC	RQ10009	QHEC	HVAC	Utilities	Electric	Direct Install	0.74	0.71	0.68	Median of 8 values from literature	6. Similar Measures, All Delivery Modes	f. Annual Decrease (3 percentage points) Due to Moderate Commercialization
Smart Thermostats - Electric A/C and Elec Heat	RQ10010	QHEC	HVAC	Utilities	Electric	Direct Install	0.74	0.71	0.68	Median of 8 values from literature	6. Similar Measures, All Delivery Modes	f. Annual Decrease (3 percentage points) Due to Moderate Commercialization
Smart Thermostat - Electric A/C and No Natural Gas	RQ10011	QHEC	HVAC	Utilities	Electric	Direct Install	0.74	0.71	0.68	Median of 8 values from literature	6. Similar Measures, All Delivery Modes	f. Annual Decrease (3 percentage points) Due to Moderate Commercialization
Smart Thermostats - No Central A/C and Elec Heat	RQ10012	QHEC	HVAC	Utilities	Electric	Direct Install	0.74	0.71	0.68	Median of 8 values from literature	6. Similar Measures, All Delivery Modes	f. Annual Decrease (3 percentage points) Due to Moderate Commercialization
All non-heat pump HVAC/WH - Multifamily		Moderate Income Weatherization	HVAC	Utilities	Electric	Direct Install	0.95	0.95	0.95	Median of 9 values from literature	6. Similar Measures, All Delivery Modes	c. 10% Moderate Income Boost
All ducted and ductless air source heat pumps and HPWH - Multifamily		Home Performance	HVAC	Utilities	Electric	Direct Install	0.93	0.93	0.93	Median of 2 MF values from literature	6. Similar Measures, All Delivery Modes	None

Measure	Unique ID #	Program	Measure Group	PA	Fuel Type	Delivery Mode	NTG 2024	NTG 2025	NTG 2026	NTG Basis	Method	Variation
All ducted and ductless air source heat pumps and HPWH - Multifamily		Moderate Income Weatherization	HVAC	Utilities	Electric	Direct Install	0.93	0.93	0.93	Median of 2 MF values from literature	6. Similar Measures, All Delivery Modes	None
All non-heat pump HVAC/WH - Multifamily		Home Performance	HVAC	Utilities	Electric	Direct Install	0.86	0.86	0.86	Median of 9 values from literature	6. Similar Measures, All Delivery Modes	none
Qualifying Gas Heat with qualifying Gas Water Heat <55gallons,UEF>.64	RH9032	Home Performance	HVAC / Waterheating	Utilities	Natural Gas	Direct Install	0.76	0.76	0.76	Median of all 11 values from literature	6. Similar Measures, All Delivery Modes	none
Qualifying Gas Heat with qualifying Gas Water Heat <55gallons,UEF>.64	RH9033	Home Performance	HVAC / Waterheating	Utilities	Natural Gas	Direct Install	0.76	0.76	0.76	Median of all 11 values from literature	6. Similar Measures, All Delivery Modes	none
Qualifying Gas Heat with qualifying Gas Water Heat <55gallons,UEF>.64	RM11031	Moderate Income Weatherization	HVAC / Waterheating	Utilities	Natural Gas	Direct Install	0.84	0.84	0.84	Median of 11 gas heat and 6 gas waterheater values in literature	8. Full Measure Group	c. 10% Moderate Income Boost
Qualifying Gas Heat with qualifying Gas Water Heat <55gallons,UEF>.64	RM11032	Moderate Income Weatherization	HVAC / Waterheating	Utilities	Natural Gas	Direct Install	0.84	0.84	0.84	Median of 11 gas heat and 6 gas waterheater values in literature	8. Full Measure Group	c. 10% Moderate Income Boost
Attic/Roof/Ceiling Insulation	RH9002	Home Performance	Insulation & Envelope	Utilities	Electric	Direct Install	0.87	0.87	0.87	Median of 11 values in literature for envelope insulation	8. Full Measure Group	none
Attic/Roof/Ceiling Insulation	RH9002	Home Performance	Insulation & Envelope	Utilities	Natural Gas	Direct Install	0.87	0.87	0.87	Median of 11 values in literature for envelope insulation	8. Full Measure Group	none

Measure	Unique ID #	Program	Measure Group	PA	Fuel Type	Delivery Mode	NTG 2024	NTG 2025	NTG 2026	NTG Basis	Method	Variation
Wall Insulation	RH9003	Home Performance	Insulation & Envelope	Utilities	Electric	Direct Install	0.87	0.87	0.87	Median of 11 values in literature for envelope insulation	8. Full Measure Group	none
Wall Insulation	RH9003	Home Performance	Insulation & Envelope	Utilities	Natural Gas	Direct Install	0.87	0.87	0.87	Median of 11 values in literature for envelope insulation	8. Full Measure Group	none
Floor Insulation	RH9004	Home Performance	Insulation & Envelope	Utilities	Electric	Direct Install	0.87	0.87	0.87	Median of 11 values in literature for envelope insulation	8. Full Measure Group	none
Floor Insulation	RH9004	Home Performance	Insulation & Envelope	Utilities	Natural Gas	Direct Install	0.87	0.87	0.87	Median of 11 values in literature for envelope insulation	8. Full Measure Group	none
Air Sealing	RH9005	Home Performance	Insulation & Envelope	Utilities	Electric	Direct Install	0.60	0.60	0.60	Median of 10 program-level values in literature	9. Program Level, Same Delivery Mode	none
Air Sealing	RH9005	Home Performance	Insulation & Envelope	Utilities	Natural Gas	Direct Install	0.60	0.60	0.60	Median of 10 program-level values in literature	9. Program Level, Same Delivery Mode	none
Duct Sealing	RH9006	Home Performance	Insulation & Envelope	Utilities	Electric	Direct Install	0.60	0.60	0.60	Median of 10 program-level values in literature	9. Program Level, Same Delivery Mode	none
Duct Sealing	RH9006	Home Performance	Insulation & Envelope	Utilities	Natural Gas	Direct Install	0.60	0.60	0.60	Median of 10 program-level	9. Program Level, Same Delivery Mode	none

Measure	Unique ID #	Program	Measure Group	PA	Fuel Type	Delivery Mode	NTG 2024	NTG 2025	NTG 2026	NTG Basis	Method	Variation
										values in literature		
Ductwork / Duct Insulation	RH9007	Home Performance	Insulation & Envelope	Utilities	Electric	Direct Install	0.60	0.60	0.60	Median of 10 program-level values in literature	9. Program Level, Same Delivery Mode	none
Ductwork / Duct Insulation	RH9007	Home Performance	Insulation & Envelope	Utilities	Natural Gas	Direct Install	0.60	0.60	0.60	Median of 10 program-level values in literature	9. Program Level, Same Delivery Mode	none
Attic Floor Insulation	RH9009	Home Performance	Insulation & Envelope	Utilities	Electric	Direct Install	0.87	0.87	0.87	Median of 11 values in literature for envelope insulation	8. Full Measure Group	none
Attic Floor Insulation	RH9009	Home Performance	Insulation & Envelope	Utilities	Natural Gas	Direct Install	0.87	0.87	0.87	Median of 11 values in literature for envelope insulation	8. Full Measure Group	none
Weatherstripping 17-Foot Roll Foam	RI12001	Existing Homes	Insulation & Envelope	Utilities	Electric	Direct Install	0.60	0.60	0.60	Median of 10 program-level values in literature	9. Program Level, Same Delivery Mode	none
Weatherstripping 17-Foot Roll Foam	RI12001	Existing Homes	Insulation & Envelope	Utilities	Natural Gas	Direct Install	0.60	0.60	0.60	Median of 10 program-level values in literature	9. Program Level, Same Delivery Mode	none
gaskets-10 pack	RI12002	Existing Homes	Insulation & Envelope	Utilities	Electric	Direct Install	0.60	0.60	0.60	Median of 10 program-level values in literature	9. Program Level, Same Delivery Mode	none

Measure	Unique ID #	Program	Measure Group	PA	Fuel Type	Delivery Mode	NTG 2024	NTG 2025	NTG 2026	NTG Basis	Method	Variation
gaskets-10 pack	RI12002	Existing Homes	Insulation & Envelope	Utilities	Natural Gas	Direct Install	0.60	0.60	0.60	Median of 10 program-level values in literature	9. Program Level, Same Delivery Mode	none
Attic/Roof/Ceiling Insulation	RM11001	Moderate Income Weatherization	Insulation & Envelope	Utilities	Electric	Direct Install	0.96	0.96	0.96	Median of 11 values in literature for envelope insulation	8. Full Measure Group	c. 10% Moderate Income Boost
Attic/Roof/Ceiling Insulation	RM11001	Moderate Income Weatherization	Insulation & Envelope	Utilities	Natural Gas	Direct Install	0.96	0.96	0.96	Median of 11 values in literature for envelope insulation	8. Full Measure Group	c. 10% Moderate Income Boost
Wall Insulation	RM11002	Moderate Income Weatherization	Insulation & Envelope	Utilities	Electric	Direct Install	0.96	0.96	0.96	Median of 11 values in literature for envelope insulation	8. Full Measure Group	c. 10% Moderate Income Boost
Wall Insulation	RM11002	Moderate Income Weatherization	Insulation & Envelope	Utilities	Natural Gas	Direct Install	0.96	0.96	0.96	Median of 11 values in literature for envelope insulation	8. Full Measure Group	c. 10% Moderate Income Boost
Floor Insulation	RM11003	Moderate Income Weatherization	Insulation & Envelope	Utilities	Electric	Direct Install	0.96	0.96	0.96	Median of 11 values in literature for envelope insulation	8. Full Measure Group	c. 10% Moderate Income Boost
Floor Insulation	RM11003	Moderate Income Weatherization	Insulation & Envelope	Utilities	Natural Gas	Direct Install	0.96	0.96	0.96	Median of 11 values in literature for envelope insulation	8. Full Measure Group	c. 10% Moderate Income Boost

Measure	Unique ID #	Program	Measure Group	PA	Fuel Type	Delivery Mode	NTG 2024	NTG 2025	NTG 2026	NTG Basis	Method	Variation
Air Sealing	RM11004	Moderate Income Weatherization	Insulation & Envelope	Utilities	Electric	Direct Install	0.66	0.66	0.66	Median of 10 program-level values in literature	9. Program Level, Same Delivery Mode	c. 10% Moderate Income Boost
Air Sealing	RM11004	Moderate Income Weatherization	Insulation & Envelope	Utilities	Natural Gas	Direct Install	0.66	0.66	0.66	Median of 10 program-level values in literature	9. Program Level, Same Delivery Mode	c. 10% Moderate Income Boost
Duct Sealing	RM11005	Moderate Income Weatherization	Insulation & Envelope	Utilities	Electric	Direct Install	0.66	0.66	0.66	Median of 10 program-level values in literature	9. Program Level, Same Delivery Mode	c. 10% Moderate Income Boost
Duct Sealing	RM11005	Moderate Income Weatherization	Insulation & Envelope	Utilities	Natural Gas	Direct Install	0.66	0.66	0.66	Median of 10 program-level values in literature	9. Program Level, Same Delivery Mode	c. 10% Moderate Income Boost
Ductwork / Duct Insulation	RM11006	Moderate Income Weatherization	Insulation & Envelope	Utilities	Electric	Direct Install	0.66	0.66	0.66	Median of 10 program-level values in literature	9. Program Level, Same Delivery Mode	c. 10% Moderate Income Boost
Ductwork / Duct Insulation	RM11006	Moderate Income Weatherization	Insulation & Envelope	Utilities	Natural Gas	Direct Install	0.66	0.66	0.66	Median of 10 program-level values in literature	9. Program Level, Same Delivery Mode	c. 10% Moderate Income Boost
Attic Floor Insulation	RM11008	Moderate Income Weatherization	Insulation & Envelope	Utilities	Electric	Direct Install	0.96	0.96	0.96	Median of 11 values in literature for envelope insulation	8. Full Measure Group	c. 10% Moderate Income Boost
Attic Floor Insulation	RM11008	Moderate Income Weatherization	Insulation & Envelope	Utilities	Natural Gas	Direct Install	0.96	0.96	0.96	Median of 11 values in literature for envelope insulation	8. Full Measure Group	c. 10% Moderate Income Boost

Measure	Unique ID #	Program	Measure Group	PA	Fuel Type	Delivery Mode	NTG 2024	NTG 2025	NTG 2026	NTG Basis	Method	Variation
Furnace/Air Handler Filter Whistle	RS13002	Existing Homes	Insulation & Envelope	Utilities	Electric	Direct Install	0.60	0.60	0.60	Median of 10 program-level values in literature	9. Program Level, Same Delivery Mode	none
Furnace/Air Handler Filter Whistle	RS13002	Existing Homes	Insulation & Envelope	Utilities	Natural Gas	Direct Install	0.60	0.60	0.60	Median of 10 program-level values in literature	9. Program Level, Same Delivery Mode	none
LED Nightlight	RL1008	Existing Homes	Lighting	Utilities	Electric	Direct Install	0.45	0.40	0.35	Evaluator Assigned based on market data	10. Evaluator Assigned	g. Annual Decrease (5 percentage points) Due to Rapid Commercialization; k. National Shipment Data
LED Specialty	RM11041	Moderate Income Weatherization	Lighting	Utilities	Electric	Direct Install	0.17	0.08	0.04	Evaluator Assigned based on market data	10. Evaluator Assigned	c. 10% Moderate Income Boost; i. 50% Annual Decrease Due to AML and State and Federal Standards; j. NJ Market Research
LED Standard	RM11042	Moderate Income Weatherization	Lighting	Utilities	Electric	Direct Install	0.17	0.08	0.04	Evaluator Assigned based on market data	10. Evaluator Assigned	c. 10% Moderate Income Boost; i. 50% Annual Decrease Due to AML and State and Federal Standards; j. NJ Market Research
QHEC - LED Specialty	RQ10001	QHEC	Lighting	Utilities	Electric	Direct Install	0.15	0.08	0.04	Evaluator Assigned based on market data	10. Evaluator Assigned	i. 50% Annual Decrease Due to AML and State and Federal Standards; j. NJ Market Research
QHEC - LED Standard	RQ10002	QHEC	Lighting	Utilities	Electric	Direct Install	0.15	0.08	0.04	Evaluator Assigned based on market data	10. Evaluator Assigned	i. 50% Annual Decrease Due to AML and State and Federal Standards; j. NJ Market Research
SMART STRIP	RM11046	Moderate Income Weatherization	Plug Loads	Utilities	Electric	Direct Install	1.00	1.00	1.00	Evaluator Assigned based on market data	10. Evaluator Assigned	I. Broad Market Trends

Measure	Unique ID #	Program	Measure Group	PA	Fuel Type	Delivery Mode	NTG 2024	NTG 2025	NTG 2026	NTG Basis	Method	Variation
QHEC- SMART STRIP	RQ10006	QHEC	Plug Loads	Utilities	Electric	Direct Install	0.90	0.90	0.90	Evaluator Assigned based on market data	10. Evaluator Assigned	I. Broad Market Trends
Gas Storage Tank waterheater - Power Vented <55 gallons, UEF>.64	RH9035	Home Performance	Waterheating	Utilities	Natural Gas	Direct Install	0.76	0.76	0.76	Median of 6 value from literature	6. Similar Measures, All Delivery Modes	None
Gas Storage Tank waterheater - Power Vented >55 gallons, UEF>.85	RH9036	Home Performance	Waterheating	Utilities	Natural Gas	Direct Install	0.76	0.76	0.76	Median of 6 value from literature	6. Similar Measures, All Delivery Modes	None
Tankless WH, UEF>=0.87	RH9037	Home Performance	Waterheating	Utilities	Natural Gas	Direct Install	0.76	0.76	0.76	Median of all 11 values from literature	6. Similar Measures, All Delivery Modes	none
Indirect - Fired Storage Tank waterheater*	RH9038	Home Performance	Waterheating	Utilities	Natural Gas	Direct Install	0.76	0.76	0.76	Median of all 11 values from literature	6. Similar Measures, All Delivery Modes	none
Heat Pump waterheater	RH9047	Home Performance	Waterheating	Utilities	Electric	Direct Install	0.78	0.78	0.78	Median of 2 value from literature	5. Similar Measures, Delivery Mode	None
Gas Storage Tank waterheater - Power Vented <55 gallons, UEF>.64	RM11034	Moderate Income Weatherization	Waterheating	Utilities	Natural Gas	Direct Install	0.84	0.84	0.84	Median of 6 values from literature	6. Similar Measures, All Delivery Modes	c. 10% Moderate Income Boost
Gas Storage Tank waterheater - Power Vented >55 gallons, UEF>.85	RM11035	Moderate Income Weatherization	Waterheating	Utilities	Natural Gas	Direct Install	0.84	0.84	0.84	Median of 6 values from literature	6. Similar Measures, All Delivery Modes	c. 10% Moderate Income Boost
Tankless WH, UEF>=0.87	RM11036	Moderate Income Weatherization	Waterheating	Utilities	Natural Gas	Direct Install	0.84	0.84	0.84	Median of 11 gas heat and 6 gas waterheater values in literature	8. Full Measure Group	c. 10% Moderate Income Boost

Measure	Unique ID #	Program	Measure Group	PA	Fuel Type	Delivery Mode	NTG 2024	NTG 2025	NTG 2026	NTG Basis	Method	Variation
Indirect - Fired Storage Tank waterheater*	RM11037	Moderate Income Weatherization	Waterheating	Utilities	Natural Gas	Direct Install	0.84	0.84	0.84	Median of 11 gas heat and 6 gas waterheater values in literature	8. Full Measure Group	c. 10% Moderate Income Boost
Faucet Aerator	RM11043	Moderate Income Weatherization	Waterheating	Utilities	Electric	Direct Install	0.66	0.66	0.66	Median of 10 program-level values in literature	9. Program Level, Same Delivery Mode	c. 10% Moderate Income Boost
Faucet Aerator	RM11043	Moderate Income Weatherization	Waterheating	Utilities	Natural Gas	Direct Install	0.66	0.66	0.66	Median of 10 program-level values in literature	9. Program Level, Same Delivery Mode	c. 10% Moderate Income Boost
Efficient Flow Showerhead - not TSV	RM11044	Moderate Income Weatherization	Waterheating	Utilities	Electric	Direct Install	0.66	0.66	0.66	Median of 10 program-level values in literature	9. Program Level, Same Delivery Mode	c. 10% Moderate Income Boost
Efficient Flow Showerhead - not TSV	RM11044	Moderate Income Weatherization	Waterheating	Utilities	Natural Gas	Direct Install	0.66	0.66	0.66	Median of 10 program-level values in literature	9. Program Level, Same Delivery Mode	c. 10% Moderate Income Boost
Kitchen Faucet Aerator	RM11045	Moderate Income Weatherization	Waterheating	Utilities	Electric	Direct Install	0.66	0.66	0.66	Median of 10 program-level values in literature	9. Program Level, Same Delivery Mode	c. 10% Moderate Income Boost
Kitchen Faucet Aerator	RM11045	Moderate Income Weatherization	Waterheating	Utilities	Natural Gas	Direct Install	0.66	0.66	0.66	Median of 10 program-level values in literature	9. Program Level, Same Delivery Mode	c. 10% Moderate Income Boost
PIPE INSULATION	RM11047	Moderate Income Weatherization	Waterheating	Utilities	Electric	Direct Install	0.66	0.66	0.66	Median of 10 program-level values in literature	9. Program Level, Same Delivery Mode	c. 10% Moderate Income Boost

Measure	Unique ID #	Program	Measure Group	PA	Fuel Type	Delivery Mode	NTG 2024	NTG 2025	NTG 2026	NTG Basis	Method	Variation
PIPE INSULATION	RM11047	Moderate Income Weatherization	Waterheating	Utilities	Natural Gas	Direct Install	0.66	0.66	0.66	Median of 10 program-level values in literature	9. Program Level, Same Delivery Mode	c. 10% Moderate Income Boost
Thermostatic Restrictor Shower Valve	RM11055	Existing Homes	Waterheating	Utilities	Electric	Direct Install	0.90	0.90	0.90	Evaluator Assigned based on market data	10. Evaluator Assigned	I. Broad Market Trends
Thermostatic Restrictor Shower Valve	RM11055	Existing Homes	Waterheating	Utilities	Natural Gas	Direct Install	0.90	0.90	0.90	Evaluator Assigned based on market data	10. Evaluator Assigned	I. Broad Market Trends
Heat Pump waterheater	RM11060	Moderate Income Weatherization	Waterheating	Utilities	Electric	Direct Install	0.86	0.86	0.86	Median of 2 values from literature	5. Similar Measures, Delivery Mode	c. 10% Moderate Income Boost
ShowerStart showerhead adapter	RNMR-4	QHEC	Waterheating	Joint	Natural Gas	Direct Install	0.90	0.90	0.90	Evaluator Assigned based on market data	10. Evaluator Assigned	I. Broad Market Trends
ShowerStart showerhead adapter - Multifamily	RNMR-5	QHEC	Waterheating	Joint	Electric	Direct Install	0.90	0.90	0.90	Evaluator Assigned based on market data	10. Evaluator Assigned	I. Broad Market Trends
QHEC- Faucet Aerator	RQ10003	QHEC	Waterheating	Utilities	Natural Gas	Direct Install	0.60	0.60	0.60	Median of 10 program-level values in literature	9. Program Level, Same Delivery Mode	none
QHEC- Faucet Aerator	RQ10003	QHEC	Waterheating	Utilities	Electric	Direct Install	0.60	0.60	0.60	Median of 10 program-level values in literature	9. Program Level, Same Delivery Mode	none
QHEC- Efficient Flow Showerhead - not TSV	RQ10004	QHEC	Waterheating	Utilities	Electric	Direct Install	0.60	0.60	0.60	Median of 10 program-level values in literature	9. Program Level, Same Delivery Mode	none

Measure	Unique ID #	Program	Measure Group	PA	Fuel Type	Delivery Mode	NTG 2024	NTG 2025	NTG 2026	NTG Basis	Method	Variation
QHEC- Efficient Flow Showerhead - not TSV	RQ10004	QHEC	Waterheating	Utilities	Natural Gas	Direct Install	0.60	0.60	0.60	Median of 10 program-level values in literature	9. Program Level, Same Delivery Mode	none
QHEC- Kitchen Faucet Aerator	RQ10005	QHEC	Waterheating	Utilities	Natural Gas	Direct Install	0.60	0.60	0.60	Median of 10 program-level values in literature	9. Program Level, Same Delivery Mode	none
QHEC- Kitchen Faucet Aerator	RQ10005	QHEC	Waterheating	Utilities	Electric	Direct Install	0.60	0.60	0.60	Median of 10 program-level values in literature	9. Program Level, Same Delivery Mode	none
QHEC- PIPE INSULATION	RQ10007	QHEC	Waterheating	Utilities	Electric	Direct Install	0.60	0.60	0.60	Median of 10 program-level values in literature	9. Program Level, Same Delivery Mode	none
Waterheater setback	RW3006	Existing Homes	Waterheating	Utilities	Electric	Direct Install	0.60	0.60	0.60	Median of 10 program-level values in literature	9. Program Level, Same Delivery Mode	none
Waterheater setback	RW3006	Existing Homes	Waterheating	Utilities	Natural Gas	Direct Install	0.60	0.60	0.60	Median of 10 program-level values in literature	9. Program Level, Same Delivery Mode	none
Replacement of inefficient refrigerators	RNMR-6	Comfort Partners	Appliances	Joint	Electric	Direct Install	1.00	1.00	1.00	Low Income	1. Low Income	None
Comprehensive, personalized energy education and counseling	RNMR-36	Comfort Partners	Behavioral	Joint	Natural Gas	Direct Install	1.00	1.00	1.00	Low Income	1. Low Income	None
Comprehensive, personalized energy	RNMR-37	Comfort Partners	Behavioral	Joint	Electric	Direct Install	1.00	1.00	1.00	Low Income	1. Low Income	None

Measure	Unique ID #	Program	Measure Group	PA	Fuel Type	Delivery Mode	NTG 2024	NTG 2025	NTG 2026	NTG Basis	Method	Variation
education and counseling												
Thermostats	RNMR-10	Comfort Partners	HVAC	Joint	Natural Gas	Direct Install	1.00	1.00	1.00	Low Income	1. Low Income	None
Heating/cooling equipment maintenance; and other measures	RNMR-7	Comfort Partners	HVAC	Joint	Electric	Direct Install	1.00	1.00	1.00	Low Income	1. Low Income	None
Heating/cooling equipment maintenance; and other measures	RNMR-8	Comfort Partners	HVAC	Joint	Natural Gas	Direct Install	1.00	1.00	1.00	Low Income	1. Low Income	None
Thermostats	RNMR-9	Comfort Partners	HVAC	Joint	Electric	Direct Install	1.00	1.00	1.00	Low Income	1. Low Income	None
Air Sealing	RNMR-11	Comfort Partners	Insulation & Envelope	Joint	Natural Gas	Direct Install	1.00	1.00	1.00	Low Income	1. Low Income	None
Air Sealing	RNMR-12	Comfort Partners	Insulation & Envelope	Joint	Electric	Direct Install	1.00	1.00	1.00	Low Income	1. Low Income	None
Duct sealing and repair	RNMR-13	Comfort Partners	Insulation & Envelope	Joint	Natural Gas	Direct Install	1.00	1.00	1.00	Low Income	1. Low Income	None
Duct sealing and repair	RNMR-14	Comfort Partners	Insulation & Envelope	Joint	Electric	Direct Install	1.00	1.00	1.00	Low Income	1. Low Income	None
EEP Door Sealing	RNMR-15	Comfort Partners	Insulation & Envelope	Joint	Natural Gas	Direct Install	1.00	1.00	1.00	Low Income	1. Low Income	None
EEP Door Sealing	RNMR-16	Comfort Partners	Insulation & Envelope	Joint	Electric	Direct Install	1.00	1.00	1.00	Low Income	1. Low Income	None
EEP Door Sweeps	RNMR-17	Comfort Partners	Insulation & Envelope	Joint	Natural Gas	Direct Install	1.00	1.00	1.00	Low Income	1. Low Income	None
EEP Door Sweeps	RNMR-18	Comfort Partners	Insulation & Envelope	Joint	Electric	Direct Install	1.00	1.00	1.00	Low Income	1. Low Income	None
EEP Foam Sealant	RNMR-19	Comfort Partners	Insulation & Envelope	Joint	Natural Gas	Direct Install	1.00	1.00	1.00	Low Income	1. Low Income	None

Measure	Unique ID #	Program	Measure Group	PA	Fuel Type	Delivery Mode	NTG 2024	NTG 2025	NTG 2026	NTG Basis	Method	Variation
EEP Foam Sealant	RNMR-20	Comfort Partners	Insulation & Envelope	Joint	Electric	Direct Install	1.00	1.00	1.00	Low Income	1. Low Income	None
Insulation (attic, wall, etc.)	RNMR-21	Comfort Partners	Insulation & Envelope	Joint	Electric	Direct Install	1.00	1.00	1.00	Low Income	1. Low Income	None
Insulation (attic, wall, etc.)	RNMR-22	Comfort Partners	Insulation & Envelope	Joint	Natural Gas	Direct Install	1.00	1.00	1.00	Low Income	1. Low Income	None
Efficient Fixtures - retrofit kits and integrated luminaires (otherwise use screw-in lamp)	RNMR-23	Comfort Partners	Lighting	Joint	Electric	Direct Install	0.00	0.00	0.00	Federal or state standard	3. Federal or State Standard	None
Horticultural LEDs	RNMR-24	Comfort Partners	Lighting	Joint	Electric	Direct Install	1.00	1.00	1.00	Low Income	1. Low Income	None
Ceiling Fans - integrated luminaire (otherwise use screw-in lamp)	RNMR-25	Comfort Partners	Lighting	Joint	Electric	Direct Install	0.00	0.00	0.00	Federal or state standard	3. Federal or State Standard	None
LED Screw In Lamp	RNMR-26	Comfort Partners	Lighting	Joint	Electric	Direct Install	0.18	0.09	0.05	Evaluator Assigned based on market data	10. Evaluator Assigned	h. 10% Low Income Boost (over moderate); i. 50% Annual Decrease Due to AML and State and Federal Standards; j. NJ Market Research
ShowerStart showerhead adapter - assume TSV	RNMR-27	Comfort Partners	Waterheating	Joint	Electric	Direct Install	1.00	1.00	1.00	Low Income	1. Low Income	None
ShowerStart showerhead adapter - assume TSV	RNMR-28	Comfort Partners	Waterheating	Joint	Natural Gas	Direct Install	1.00	1.00	1.00	Low Income	1. Low Income	None
Low flow faucet aerators (Electric)	RNMR-29	Comfort Partners	Waterheating	Joint	Electric	Direct Install	1.00	1.00	1.00	Low Income	1. Low Income	None

Measure	Unique ID #	Program	Measure Group	PA	Fuel Type	Delivery Mode	NTG 2024	NTG 2025	NTG 2026	NTG Basis	Method	Variation
Low flow Showerhead - not TSV	RNMR-30	Comfort Partners	Waterheating	Joint	Electric	Direct Install	1.00	1.00	1.00	Low Income	1. Low Income	None
Low flow Showerhead - not TSV	RNMR-31	Comfort Partners	Waterheating	Joint	Natural Gas	Direct Install	1.00	1.00	1.00	Low Income	1. Low Income	None
waterheater insulation	RNMR-32	Comfort Partners	Waterheating	Joint	Electric	Direct Install	1.00	1.00	1.00	Low Income	1. Low Income	None
waterheater insulation	RNMR-33	Comfort Partners	Waterheating	Joint	Natural Gas	Direct Install	1.00	1.00	1.00	Low Income	1. Low Income	None
Water pipe insulation	RNMR-34	Comfort Partners	Waterheating	Joint	Electric	Direct Install	1.00	1.00	1.00	Low Income	1. Low Income	None
Water pipe insulation	RNMR-35	Comfort Partners	Waterheating	Joint	Natural Gas	Direct Install	1.00	1.00	1.00	Low Income	1. Low Income	None
ZERH + RE Multifamily		RNC	Whole Program	NJCEP	Both	Midstream	0.90	0.90	0.90	Evaluator Assigned based on market data	10. Evaluator Assigned	I. Broad Market Trends
ZERH Multifamily		RNC	Whole Program	NJCEP	Both	Midstream	0.85	0.85	0.85	Evaluator Assigned based on market data	10. Evaluator Assigned	I. Broad Market Trends
ZERH + RE Single-family + Townhouse		RNC	Whole Program	NJCEP	Both	Midstream	0.85	0.85	0.85	Evaluator Assigned based on market data	10. Evaluator Assigned	I. Broad Market Trends
ENERGY STAR Multifamily		RNC	Whole Program	NJCEP	Both	Midstream	0.80	0.80	0.80	Evaluator Assigned based on market data	10. Evaluator Assigned	I. Broad Market Trends
ZERH Single-family + Townhouse		RNC	Whole Program	NJCEP	Both	Midstream	0.80	0.80	0.80	Evaluator Assigned based on market data	10. Evaluator Assigned	I. Broad Market Trends
ENERGY STAR Single-family + Townhouse		RNC	Whole Program	NJCEP	Both	Midstream	0.75	0.75	0.75	Evaluator Assigned based on market data	10. Evaluator Assigned	I. Broad Market Trends

Measure	Unique ID #	Program	Measure Group	PA	Fuel Type	Delivery Mode	NTG 2024	NTG 2025	NTG 2026	NTG Basis	Method	Variation
UEZ / Affordable house Bonus - Single-family + Townhouse		RNC	Whole Program	NJCEP	Both	Midstream	0.00	Add 5% to NTG to each tier above	Add 5% to NTG to each tier above	Evaluator Assigned based on market data	10. Evaluator Assigned	I. Broad Market Trends

12 APPENDIX I: REALIZATION RATES

Prospective realization rates to be applied to gross savings estimates are based on PY1 Evaluation Study findings. Realization rates where sample sizes are < 30 or savings discrepancies are addressed by the 2023 TRM were removed. Measures not listed below do not require a prospective realization rate adjustment.

IOU	Program	Sub Program	Measure	GRR net of ISR		
				kWh	kW	Therm
ACE	Efficient Products	Appliance Rebate	Clothes Dryers	101%	101%	
ACE	Efficient Products	Appliance Rebate	Dehumidifiers	113%	113%	
ACE	Efficient Products	Appliance Rebate	Heat Pump Water Heaters	100%	100%	
ACE	Efficient Products	Appliance Rebate	Refrigerators	101%	101%	
ACE	Efficient Products	Appliance Rebate	Room Air Conditioners	125%	128%	
ACE	Efficient Products	Appliance Recycling	Dehumidifiers	100%	100%	
ACE	Efficient Products	Appliance Recycling	Freezers	101%	101%	
ACE	Efficient Products	Appliance Recycling	Refrigerators	100%	100%	
ACE	Efficient Products	Appliance Recycling	Room Air Conditioners	100%	100%	
ACE	Efficient Products	HVAC	Smart Thermostats	100%		
ACE	Efficient Products	Online Marketplace	Power Strips	100%	102%	
ACE	Efficient Products	Online Marketplace	Smart Thermostats	100%	101%	
ETG	EE Products	HVAC	Gas Boiler			104%
ETG	EE Products	HVAC	Gas Furnace			108%
ETG	EE Products	Marketplace Efficiency Products	Smart Thermostat	100%		100%
JCPL	Efficient Products	Appliance Rebates	Air Purifier – ENERGY STAR	100%	100%	

IOU	Program	Sub Program	Measure	GRR net of ISR		
				kWh	kW	Therm
JCPL	Efficient Products	Appliance Rebates	Clothes Dryer – ENERGY STAR	99%	99%	
JCPL	Efficient Products	Appliance Rebates	Clothes Dryer – ENERGY STAR MOST EFFICIENT	99%	99%	
JCPL	Efficient Products	Appliance Rebates	Refrigerator – ENERGY STAR	100%	100%	
JCPL	Efficient Products	Appliance Rebates	Refrigerator – ENERGY STAR MOST EFFICIENT	100%	100%	
JCPL	Efficient Products	Appliance Recycling	Dehumidifier Recycling	100%	100%	
JCPL	Efficient Products	Appliance Recycling	Freezer Recycling	100%	100%	
JCPL	Efficient Products	Appliance Recycling	Refrigerator Recycling	100%	100%	
JCPL	Efficient Products	HVAC	Smart Thermostat – Electric A/C and Elec Heat	100%		
JCPL	Efficient Products	HVAC	Smart Thermostat – Electric A/C and No Natural Gas	100%		
JCPL	Efficient Products	HVAC	Smart Thermostat – Gas Heat w/ CAC	100%		100%
JCPL	Efficient Products	Online Marketplace	Air purifier	100%	100%	
JCPL	Efficient Products	Online Marketplace	Smart Thermostat	99%		99%
JCPL	Existing Homes	Moderate Income Weatherization	Advanced Power Strips	100%	100%	
JCPL	Existing Homes	Moderate Income Weatherization	Domestic Hot Water Setback	100%	100%	
JCPL	Existing Homes	Moderate Income Weatherization	Faucet Aerators	100%	-	
JCPL	Existing Homes	Moderate Income Weatherization	LED Lightbulbs	100%	100%	
JCPL	Existing Homes	Moderate Income Weatherization	Low Flow Showerheads	100%	-	
JCPL	Existing Homes	QHEC	Domestic Hot Water Setback	108%	108%	
JCPL	Multifamily	Direct Install	LED Nightlight - Tenant	100%	-	

IOU	Program	Sub Program	Measure	GRR net of ISR		
				kWh	kW	Therm
NJNG	Existing Homes	QHEC	LED Nightlight	100%	100%	
NJNG	Existing Homes	QHEC	LED Screw-in General Service Lamp	100%	100%	
PSEG	Efficient Products	Appliance Recycling	Dehumidifier	100%	100%	
PSEG	Efficient Products	Appliance Recycling	Freezer	100%	100%	
PSEG	Efficient Products	Appliance Recycling	Refrigerator	100%	100%	
PSEG	Efficient Products	Downstream Rebates	Clothes Washer	100%	100%	100%
PSEG	Efficient Products	Downstream Rebates	Electric Clothes Dryers	100%	100%	
PSEG	Efficient Products	Downstream Rebates	Gas Clothes Dryers	100%	100%	100%
PSEG	Efficient Products	Downstream Rebates	Heat Pump Water Heater	100%	100%	
PSEG	Efficient Products	Downstream Rebates	Refrigerators	99%	99%	
PSEG	Efficient Products	Downstream Rebates	Smart Thermostat	100%		100%
PSEG	Efficient Products	Downstream Rebates	Storage Water heater			101%
PSEG	Efficient Products	Downstream Rebates	Tankless Water Heater			52%
PSEG	Efficient Products	Midstream HVAC	Air Source Heat Pump	100%	100%	
PSEG	Efficient Products	Midstream HVAC	Central Air Conditioner	98%	98%	
PSEG	Efficient Products	Midstream HVAC	Fired Storage Tank WH			63%
PSEG	Efficient Products	Midstream HVAC	Gas Boiler			102%
PSEG	Efficient Products	Midstream HVAC	Gas Furnace			100%

IOU	Program	Sub Program	Measure	GRR net of ISR		
				kWh	kW	Therm
PSE G	Efficient Products	Midstream HVAC	Heat Pump Water Heater	100%	100%	
PSE G	Efficient Products	Midstream HVAC	Qualifying Gas Furnace with qualifying Gas Water Heat			100%
PSE G	Efficient Products	Midstream HVAC	Qualifying Gas Heat with qualifying Gas Water Heat			99%
PSE G	Efficient Products	Midstream HVAC	Smart Thermostat	100%		100%
PSE G	Efficient Products	Midstream HVAC	Tankless Water Heater			13%
PSE G	Efficient Products	Midstream HVAC	Water Heater			92%
PSE G	Efficient Products	Midstream Lighting	LED Specialty - ESTAR V2.0	102%	102%	
PSE G	Efficient Products	Midstream Lighting	LED Standard - ESTAR V2.0	100%	100%	
PSE G	Efficient Products	Midstream Markdown	Air Purifier	100%	100%	
PSE G	Efficient Products	Midstream Markdown	Dehumidifier	100%	100%	
PSE G	Efficient Products	Midstream Markdown	RAC	100%	100%	
PSE G	Efficient Products	Online Marketplace	Advanced Power Strip	100%	100%	
PSE G	Efficient Products	Online Marketplace	Aerator	100%		100%
PSE G	Efficient Products	Online Marketplace	Air Quality - Air Purifier	100%	100%	
PSE G	Efficient Products	Online Marketplace	Air Quality - Dehumidifier	100%	100%	
PSE G	Efficient Products	Online Marketplace	Lighting	100%	100%	100%
PSE G	Efficient Products	Online Marketplace	Showerhead	100%		100%
PSE G	Efficient Products	Sightlines	Heat Pump Water Heater	100%	100%	

IOU	Program	Sub Program	Measure	GRR net of ISR		
				kWh	kW	Therm
PSE G	Efficient Products	Sightlines	Smart Thermostat	100%		100%
PSE G	Efficient Products	Sightlines	Storage Water heater			103%
PSE G	Efficient Products	Sightlines	Tankless Water Heater			52%
PSE G	Efficient Products	Welcome Kits	Welcome Kits - Gas			62%
PSE G	Existing Homes	QHEC	Low Flow Showerhead	100%		100%
PSE G	Existing Homes	QHEC	ShowerStart	100%	100%	100%
PSE G	Existing Homes	QHEC	Smart Strip	100%	100%	
PSE G	Income Eligible	IE Weatherization	ShowerStart	89%	89%	84%
PSE G	Income Eligible	IE Weatherization	Smart Strip	98%	98%	
PSE G	Income Eligible	IE Weatherization	Water Heater Setback	95%	95%	99%
PSE G	Multifamily	Direct Install	Lighting	105%	105%	
PSE G	Multifamily	Direct Install	ShowerStart Showerhead Adapter	100%	100%	61%
SJG	Efficient Products	Appliance Rebates	Clothes Dryer			100%
SJG	Efficient Products	Appliance Rebates	Clothes Washer Tier 1	139%	145%	86%
SJG	Efficient Products	Appliance Rebates	Clothes Washer Tier 2	139%	139%	82%
SJG	Efficient Products	HVAC	Central Air Conditioner (Tier 1)	85%	85%	
SJG	Efficient Products	HVAC	Gas Boiler			105%
SJG	Efficient Products	HVAC	Gas Combination Heater			183%

IOU	Program	Sub Program	Measure	GRR net of ISR		
				kWh	kW	Therm
SJG	Efficient Products	HVAC	Gas Furnace			99%
SJG	Efficient Products	HVAC	Gas Furnace with Water Heater			54%
SJG	Efficient Products	HVAC	Gas Storage Tank Water Heater			194%
SJG	Efficient Products	HVAC	Tankless Water Heater			103%
SJG	Efficient Products	Marketplace Efficiency Products	Smart Thermostat	100%		100%
SJG	Existing Homes	QHEC	Advanced Power Strips	100%	100%	

13 APPENDIX J: IN-SERVICE RATES

The table below presents ISR values differentiated by measure, program, and IOU. If no data is provided, use default value.

IOU	Program	Sub Program	Measure	ISR
ACE	EE Products	Appliance Rebates	Air Purifiers	0.99
ACE	EE Products	Appliance Rebates	Clothes Dryer	0.98
ACE	EE Products	Appliance Rebates	Clothes Washers	0.98
ACE	EE Products	Appliance Rebates	Dehumidifiers	0.98
ACE	EE Products	Appliance Rebates	Heat Pump Water Heaters	1.00
ACE	EE Products	Appliance Rebates	Refrigerators	0.99
ACE	EE Products	Appliance Rebates	Room Air Conditioners	1.00
ACE	EE Products	Online Marketplace	Advanced Power Strip	0.98
ACE	EE Products	Online Marketplace	Air Purifiers	1.00
ACE	EE Products	Online Marketplace	Lighting	1.03
ACE	EE Products	Online Marketplace	Smart Thermostat	0.99
ETG	EE Products	Online Marketplace	Bathroom Aerator	1.00
ETG	EE Products	Online Marketplace	Kit Bathroom Aerator	1.00
ETG	EE Products	Online Marketplace	Kit Kitchen Aerator	0.92
ETG	EE Products	Online Marketplace	Kit Low-Flow Showerhead	0.91
ETG	EE Products	Online Marketplace	Kitchen Aerator	0.92
ETG	EE Products	Online Marketplace	Low-Flow Showerhead	0.91
ETG	EE Products	Online Marketplace	Smart Thermostat	0.96
ETG	Existing Homes	QHEC	LED Bulb	0.98
ETG	Existing Homes	QHEC	Pipe Insulation	0.92
JCPL	C&I	C&I	Lighting	0.96
JCPL	EE Products	Appliance Rebates	Air Purifier	1.00
JCPL	EE Products	Appliance Rebates	Clothes Dryer	1.00
JCPL	EE Products	Appliance Rebates	Dehumidifier	1.00
JCPL	EE Products	Appliance Rebates	Refrigerator	1.00
JCPL	EE Products	Kits	Advanced Power Strip	0.69
JCPL	EE Products	Kits	Faucet Aerator	0.23
JCPL	EE Products	Kits	Furnace Whistle	0.04
JCPL	EE Products	Kits	LED Bulb	0.85

IOU	Program	Sub Program	Measure	ISR
JCPL	EE Products	Kits	LED Nightlight	0.62
JCPL	EE Products	Kits	Low-Flow Showerhead	0.19
JCPL	EE Products	Lighting	All except foodbank kit	0.95
JCPL	EE Products	Online Marketplace	LED Bulb	0.81
JCPL	EE Products	Res HVAC Rebates	CAC	1.00
JCPL	EE Products	Res HVAC Rebates	GSHP	1.00
JCPL	EE Products	Res HVAC Rebates	Minisplit	1.00
JCPL	EE Products	Res HVAC Rebates	Smart Thermostat	1.00
JCPL	SBDI	SBDI	Lighting	0.99
NJNG	Existing Homes	HPwES	Air Sealing & Insulation	0.99
NJNG	Existing Homes	HPwES	Duct Sealing	0.53
NJNG	Existing Homes	HPwES	Heating System	1.00
PSEG	EE Products	Downstream Rebates	Clothes Dryer	0.99
PSEG	EE Products	Downstream Rebates	Clothes Washer	1.00
PSEG	EE Products	Downstream Rebates	Refrigerator	0.98
PSEG	EE Products	Downstream Rebates	Smart thermostat	1.00
PSEG	EE Products	Downstream Rebates	Water heater	1.00
PSEG	EE Products	Midstream HVAC	HVAC	1.00
PSEG	EE Products	Midstream Lighting	Lighting	0.92
PSEG	EE Products	Online Marketplace	Advanced power strip	0.82
PSEG	EE Products	Online Marketplace	Air Purifier	1.00
PSEG	EE Products	Online Marketplace	Dehumidifier	1.00
PSEG	EE Products	Online Marketplace	Energy saving kit	0.88
PSEG	EE Products	Online Marketplace	Faucet Aerator	0.89
PSEG	EE Products	Online Marketplace	LED bulb	0.86
PSEG	EE Products	Online Marketplace	Low-Flow Showerhead	0.93
PSEG	EE Products	Online Marketplace	Smart thermostat	0.78
PSEG	EE Products	Online Marketplace	Water conservation kit	0.60
PSEG	EE Products	Welcome kits	Advanced Power Strip	0.85
PSEG	EE Products	Welcome kits	ENERGY STAR certified desk lamp	0.79
PSEG	EE Products	Welcome kits	LED Bulb	0.75

IOU	Program	Sub Program	Measure	ISR
PSEG	EE Products	Welcome kits	LED Nightlight	0.78
PSEG	EE Products	Welcome kits - gas	Bathroom Aerator	0.40
PSEG	EE Products	Welcome kits - gas	Kitchen Aerator	0.36
PSEG	EE Products	Welcome kits - gas	Low-Flow Showerhead	0.38
PSEG	Existing Homes	Multifamily	Lighting	0.98
PSEG	Existing Homes	QHEC	Advanced Power Strip	0.92
PSEG	Existing Homes	QHEC	Faucet Aerator	0.94
PSEG	Existing Homes	QHEC	LED Bulb	0.96
PSEG	Existing Homes	QHEC	LED Reflector	0.96
PSEG	Existing Homes	QHEC	LED Specialty	0.96
PSEG	Existing Homes	QHEC	Low-Flow Showerhead	0.94
PSEG	Existing Homes	QHEC	Pipe Insulation	1.00
PSEG	Existing Homes	QHEC	ShowerStart	0.94
PSEG	Existing Homes	QHEC	Smart Thermostat	1.00
PSEG	Existing Homes	Residential Income-Eligible	Advanced Power Strip	0.92
PSEG	Existing Homes	Residential Income-Eligible	Faucet Aerator	0.94
PSEG	Existing Homes	Residential Income-Eligible	Food bank LED	0.83
PSEG	Existing Homes	Residential Income-Eligible	Food Bank LED nightlight	0.20
PSEG	Existing Homes	Residential Income-Eligible	LED bulb	0.96
PSEG	Existing Homes	Residential Income-Eligible	LED Reflector	0.96
PSEG	Existing Homes	Residential Income-Eligible	LED Specialty	0.96
PSEG	Existing Homes	Residential Income-Eligible	Low-Flow Showerhead	0.94
PSEG	Existing Homes	Residential Income-Eligible	Pipe Insulation	1.00
PSEG	Existing Homes	Residential Income-Eligible	ShowerStart	0.94
PSEG	Existing Homes	Residential Income-Eligible	Smart Thermostat	1.00
PSEG	Existing Homes	Residential Income-Eligible	Water Heater Setback	1.00
SJG	EE Products	Appliance Rebates	Clothes Dryer	1.00
SJG	EE Products	Appliance Rebates	Clothes Washer (Tier 1)	1.00
SJG	EE Products	Appliance Rebates	Clothes Washer (Tier 2)	1.00
SJG	EE Products	HVAC	Central Air Conditioners (Tier 1)	0.96
SJG	EE Products	HVAC	Gas Boiler	1.00
SJG	EE Products	HVAC	Gas Combination Heater	0.92

IOU	Program	Sub Program	Measure	ISR
SJG	EE Products	HVAC	Gas Furnace	0.95
SJG	EE Products	HVAC	Gas Furnace with Water Heater	0.94
SJG	EE Products	HVAC	Gas Storage Tank Water Heater	0.97
SJG	EE Products	HVAC	Tankless Water Heater	0.97
SJG	EE Products	Online Marketplace	Bathroom Aerator	0.85
SJG	EE Products	Online Marketplace	Kitchen Aerator	0.84
SJG	EE Products	Online Marketplace	Low-Flow Showerhead	0.69
SJG	EE Products	Online Marketplace	Smart thermostat	0.96
SJG	Existing Homes	QHEC	Advanced Power Strips	0.91
SJG	Existing Homes	QHEC	LED Bulb	0.98
SJG	Existing Homes	QHEC	Pipe Insulation	0.95

14 APPENDIX K: DHW AND SPACE HEAT FUEL SPLIT

The values below should be used when customer DHW or space heat fuel type is unknown.

IOU	Program	Measure	Parameter	Value
JCPL	Appliance Rebates	Clothes Washer	% elec water heat	0.53
JCPL	EE Kits	Faucet Aerator	% elec water heat	0.68
JCPL	EE Kits	Shower Head	% elec water heat	0.71
PSEG	Online Marketplace	Any	% elec space heat	0.11
PSEG	Online Marketplace	Any	% gas space heat	0.86
PSEG	EE Kits	Any	% elec space heat	0.38
PSEG	EE Kits	Any	% gas space heat	0.61
PSEG	Online Marketplace	Any	% elec water heat	0.13
PSEG	Online Marketplace	Any	% gas water heat	0.87
PSEG	EE Kits	Any	% elec water heat	0.36
PSEG	EE Kits	Any	% gas water heat	0.63
SJG	Down-stream	Any	% gas water heat	0.86
SJG	Marketplace	Any	% gas water heat	0.83
SJG	Non-Participant	Any	% gas water heat	0.83
SJG	HER	Any	% gas water heat	0.92
SJG	QHEC	Any	% gas water heat	0.88
SJG	Down-stream	Any	% elec water heat	0.14
SJG	Marketplace	Any	% elec water heat	0.17
SJG	Non-Participant	Any	% elec water heat	0.17
SJG	HER	Any	% elec water heat	0.08
SJG	QHEC	Any	% elec water heat	0.12
ETG	Down-stream	Any	% gas water heat	0.94
ETG	Marketplace	Any	% gas water heat	0.86
ETG	Non-Participant	Any	% gas water heat	0.80
ETG	HER	Any	% gas water heat	0.87
ETG	QHEC	Any	% gas water heat	0.84
ETG	Down-stream	Any	% elec water heat	0.06
ETG	Marketplace	Any	% elec water heat	0.14
ETG	Non-Participant	Any	% elec water heat	0.20

IOU	Program	Measure	Parameter	Value
ETG	HER	Any	% elec water heat	0.13
ETG	QHEC	Any	% elec water heat	0.16
SJG	Down-stream	Any	% gas space heat	0.94
SJG	Marketplace	Any	% gas space heat	0.93
SJG	Non-Participant	Any	% gas space heat	0.90
SJG	HER	Any	% gas space heat	0.92
SJG	QHEC	Any	% gas space heat	0.91
SJG	Down-stream	Any	% elec space heat	0.06
SJG	Marketplace	Any	% elec space heat	0.07
SJG	Non-Participant	Any	% elec space heat	0.10
SJG	HER	Any	% elec space heat	0.08
SJG	QHEC	Any	% elec space heat	0.09
ETG	Down-stream	Any	% gas space heat	0.96
ETG	Marketplace	Any	% gas space heat	0.91
ETG	Non-Participant	Any	% gas space heat	0.84
ETG	HER	Any	% gas space heat	0.90
ETG	QHEC	Any	% gas space heat	0.95
ETG	Down-stream	Any	% elec space heat	0.04
ETG	Marketplace	Any	% elec space heat	0.09
ETG	Non-Participant	Any	% elec space heat	0.16
ETG	HER	Any	% elec space heat	0.10
ETG	QHEC	Any	% elec space heat	0.05
ACE	Appliance Rebates	Any	% gas water heat	0.63
ACE	Appliance Rebates	Any	% elec water heat	0.30
ACE	Appliance Rebates	Any	% gas space heat	0.78
ACE	Appliance Rebates	Any	% elec space heat	0.09
ACE	HVAC Rebates	Any	% gas space heat	0.83
ACE	HVAC Rebates	Any	% elec space heat	0.17
ACE	Marketplace	Any	% gas space heat	0.66
ACE	Marketplace	Any	% elec space heat	0.19
ACE	Marketplace	Any	% gas water heat	0.57
ACE	Marketplace	Any	% elec water heat	0.31

15 APPENDIX J: LIGHTING WATTAGES

15.1 C&I MIDSTREAM LIGHTING BASELINE WATTAGES

The tables below are taken from PA TRM Vol 3 C&I Measures, pg 38-42.

Table 15-1: Baseline Wattage, Omnidirectional Lamps

Efficient Lamp or Fixture	Minimum Lumen	Maximum Lumen	Incandescent Equivalent (For Reference Only)	Watts _{base} 2021-2026	Source
Omnidirectional, General Service Lamp, Screw-based	250	309	25	25	5, 6, 7
	310	449	25	8	
	450	749	40	13	
	750	1,049	60	20	
	1,050	1,489	75	28	
	1,490	1,999	100	39	
	2,000	2,600	125	51	
	2,601	3,000	150	62	
	3,001	3,300	200	70	
	3,301	3,999	200	200	
4,000	6,000	300	300		

Table 15-2: Baseline Wattage, Decorative Lamps

Efficient Lamp or Fixture	Minimum Lumen	Maximum Lumen	Incandescent Equivalent (For Reference Only)	Watts _{base} 2021-2026	Source
Decorative, Non-Globe, Screw-based	70	89	10	10	5, 6, 7
	90	149	15	15	
	150	299	25	25	
	300	309	40	29	
	310	499	40	9	
	500	699	60	13	
Decorative, Globe, Screw-based	250	309	25	25	5, 6, 7
	310	349	25	7	
	350	499	40	9	
	500	574	60	12	

Efficient Lamp or Fixture	Minimum Lumen	Maximum Lumen	Incandescent Equivalent (For Reference Only)	Watts _{base} 2021-2026	Source
	575	649	75	14	
	650	749	100	16	
	750	1,049	100	20	
	1,050	1,300	150	26	

Table 15-3: Baseline Wattage, Directional Lamps

Efficient Lamp or Fixture	Minimum Lumen	Maximum Lumen	Incandescent Equivalent (For Reference Only)	Watts _{base} 2021-2026	Source
Reflector Lamp; R, ER, BR, with screw-based, >=2.25" diameter	400	472	40	10	5, 6, 7
	473	524	45	11	
	525	714	50	14	
	715	937	65	18	
	938	1,259	75	24	
	1,260	1,399	90	30	
	1,400	1,739	100	35	
	1,740	2,174	120	43	
	2,175	2,624	150	53	
	2,625	2,999	175	62	
	3,000	3,300	200	70	
3,301	4,500	200	200		
Reflector Lamp; R, ER, BR, with screw-based, diameter <2.25"	400	449	40	9	5, 6, 7
	450	499	45	11	
	500	649	50	13	
	650	1,199	65	21	
ER30, BR30, BR40, or ER40	400	449	40	9	5, 6, 7
	450	499	45	11	
	500	649	50	13	
	650	1,199	65	21	
R20	400	449	40	9	5, 6, 7
	450	719	45	13	

Efficient Lamp or Fixture	Minimum Lumen	Maximum Lumen	Incandescent Equivalent (For Reference Only)	Watts _{base} 2021-2026	Source
Reflector Lamp; PAR, MR, MRX	400	472	Custom ¹⁶⁷	10	5, 6, 7
	473	524		11	
	525	714		14	
	715	937		18	
	938	1,259		24	
	1,260	1,399		30	
	1,400	1,739		35	
	1,740	2,174		43	
	2,175	2,624		53	
	2,625	2,999		62	
	3,000	3,300		70	
3,301	4,500	200			
All reflector lamps < 400 lumen	200	309	20	20	5, 6, 7
	310	399	30	8	

Table 15-4: Baseline Wattage, Linear Lamps & Fixtures, HID Interior and Exterior Fixtures

Efficient Lamp or Fixture	Minimum Lumen	Maximum Lumen	Watts _{base}	Note	Source
Linear Lamp, 2 ft			16.5	Baseline is standard T8 lamp adjusted for fixture and ballast	Appendix C; 17 4 ft 2 lamp T8 fixture 59 watt/2 = 29.5 watt / lamp
Linear Lamp, < 3,200 lumen, 4 ft			29.5	Baseline is standard T8 lamp adjusted for fixture and ballast	
Linear Lamp, ≥ 3,200 lumen, 4 ft			54	Baseline is T5 HO	
Linear Lamp, 5 ft			40	Baseline is standard T8	
Linear Lamp, 6 ft			65	Baseline is standard T8	

¹⁶⁷ Use one of the following approaches to determine the incandescent equivalent for PAR, MR and MRX bulbs: (1) If the ENERGY STAR Qualified Products List (QPL) (<https://data.energystar.gov/Active-Specifications/ENERGY-STAR-Certified-Light-Bulbs/v33x-ybr3>) provides a value for “Wattage Equivalency (watts),” use that value. (2) If the product does not have the aforementioned value, enter the bulb’s beam angle, center beam candle power, and diameter into the ENERGY STAR Center Beam Candle Power tool (<http://energystar.supportportal.com/link/portal/23002/23018/Article/32655/>).

Efficient Lamp or Fixture	Minimum Lumen	Maximum Lumen	Watts _{base}	Note	Source	
Linear Lamp, 8 ft		4,000	59	Baseline is standard T8		
Linear Lamp, 8 ft HO	4,001		86	Baseline is HO T8		
Linear LED Fixture, 2 ft	1,500	3,500	33	Baseline is standard 2L T8	Linear LED Fixture Max Lumen = Number lamps x Lumen Output x Fixture Efficiency x Ballast Factor; where 4' T8 mean lumen = 3,199, fixture efficiency = 74%, ballast factor = 0.90	
Linear LED Fixture, 2 ft	3,501	5,500	61	Baseline is standard 4L T8		
Linear LED Fixture, 4 ft		< 2,132	31	Baseline is standard 1L T8		
Linear LED Fixture, 4 ft	2,132	4,261	59	Baseline is standard 2L T8		
Linear LED Fixture, 4 ft	4,262	6,392	89	Baseline is standard 3L T8		
Linear LED Fixture, 4 ft	6,393	9,400	112	Baseline is standard 4L T8		
Linear LED Fixture, 8 ft		< 3,290	58	Baseline is standard 1L T8		
Linear LED Fixture, 8 ft	3,291	6,580	109	Baseline is standard 2L T8		
Linear LED Fixture, 8 ft	6,581	9,870	167	Baseline is standard 3L T8		
Linear LED Fixture, 8 ft	9,871		219	Baseline is standard 4L T8		
Highbay & Lowbay LED Fixture	3,850	6,550	135	Average 150 watt HID lamp/ T8 HLO		LED Lumen Equivalent = HID Initial Lamp Lumen x HID LLD at 40% rated life x HID Fixture Efficiency HID LLD = 75.8%, HID Fixture Efficiency = 80.4%; survey of manufacturer data, MH, PSMH
	6,551	9,300	168	Average 175 watt HID lamp/ T8 HLO		
	9,301	11,150	198	Average 200 watt HID lamp/ T8 HLO		
	11,151	12,200	236	Average 250 watt HID lamp/ T8 HLO		
	12,201	15,550	289	Average 320 watt HID lamp/ T8 HLO		
	15,551	20,100	367	Average 400 watt HID lamp/ T8 HLO		
	20,101	34,700	634	Average 750 watt HID lamp/ T8 HLO		
	34,701	57,250	901	Average 1,000 watt HID lamp/ T8 HLO		
	250	4,650	133	100 watt HID lamp	9, 11, 12, 13, 14, 15	

Efficient Lamp or Fixture	Minimum Lumen	Maximum Lumen	Watts _{base}	Note	Source
Exterior Fixture (Pole, Wall Pack or Parking Garage)	4,651	7,900	215	175 watt HID lamp	LED Lumen Equivalent = HID Initial Lamp Lumen x HID LLD at 40% rated life x HID Fixture Efficiency x DLC adjustment DLC Adjust = 80/70 lumen/watt where 80 is DLC minimum for indoor highbay, 70 for outdoor, HID LLD = 75.8%, HID Fixture Efficiency = 81.5%; survey of manufacturer data, MH, PSMH, HPS 9, 11, 12, 13, 14, 15, 16
	7,901	11,050	295	250 watt HID lamp	
	11,051	24,700	462	400 watt HID lamp	
	24,701	40,750	843	750 watt HID lamp	
	40,751	54,650	1,090	1,000 watt HID lamp	

Sources used in this appendix:

1. Williams, A., Atkinson, B., Garbesi, K., Rubinstein, F., "A Meta-Analysis of Energy Savings from Lighting Controls in Commercial Buildings", Lawrence Berkeley National Laboratory, September 2011.
http://eetd.lbl.gov/sites/all/files/a_meta-analysis_of_energy_savings_from_lighting_controls_in_commercial_buildings_lbnl-5095e.pdf
2. Pennsylvania Statewide Act 129 2014 Commercial & Residential Lighting Metering Study. Prepared for Pennsylvania Public Utilities Commission. January 13, 2015. <http://www.puc.pa.gov/pcdocs/1340978.pdf>
3. Efficiency Vermont Technical Reference User Manual (TRM), March 16, 2015.
https://puc.vermont.gov/sites/psbnew/files/doc_library/ev-technical-reference-manual.pdf

4. Illinois Statewide Technical Reference Manual for Energy Efficiency v7.0, 4.5.4 LED Bulbs and Fixtures. http://ilsagfiles.org/SAG_files/Technical_Reference_Manual/Version_7/Final_9-28-18/IL-TRM_Effective_010119_v7.0_Vol_2_C_and_I_092818_Final.pdf.
5. Energy Independence and Security Act (“EISA”) of 2007. <https://www.congress.gov/bill/110th-congress/house-bill/6>. EISA requires all general service lamps sold on or after 1/1/2020 to meet efficacy requirements of 45 Lm/W.
6. Energy Conservation Program: Energy Conservation Standards for General Service Lamps. 82 Fed. Reg. 12 (January 19, 2017). Federal Register: The Daily Journal of the United States. Amends the definition of general service lamps to cover the vast majority of screw-base lamps (including incandescent reflectors) with initial lumen output of greater than or equal to 310 lumens and less than or equal to 3,300 lumens.
7. ENERGY STAR® Program Requirements for Lamps (Light Bulbs) V2.1. <https://www.energystar.gov/sites/default/files/ENERGY%20STAR%20Lamps%20V2.1%20Final%20Specification.pdf>
8. ENERGY STAR® Lamps Center Beam Intensity Benchmark Tool. <https://www.energystar.gov/sites/default/files/ESLampCenterBeamTool%20rev%202016-09-01.xlsx>
9. Design Lights Consortium, Qualified Products List, www.designlights.org
10. US Department of Energy, CALiPER Benchmark Report. Performance of T12 and T8 Fluorescent Lamps and Troffers and LED Linear Replacement Lamps. Page 5. January 2009. <http://www.pnl.gov/publications/abstracts.asp?report=251010>.
11. Lamp and Ballast Catalogue, 2014-2015, Osram, www.osram-america.com.
12. US Department of Energy, Lumen Maintenance and Light Loss Factors, September 2013, www.pnnl.gov/main/publications/external/technical_reports/PNNL-22727.pdf
13. GE Lamps and Ballasts Catalogue, 2015-2016, <http://www.gelighting.com/LightingWeb/na/smart-catalog.jsp>.
14. Lithonia, 2016, <http://www.lithonia.com/psg/>.
15. Eaton Cooper, <http://www.cooperindustries.com/content/public/en/lighting.html>.
16. DOE LED Lighting Facts, <http://www.lightingfacts.com/>.
17. The Pennsylvania Statewide Act 129 2018 SWE Commercial and Industrial Baseline study, Table 16. On average, 13% of statewide connected load is controlled by advanced controls (occupancy sensors, photocells, EMS, etc.), resulting in a weighted average 3.47% baseline controls factor.

15.2 FIXTURE WATTAGES BY TYPE

The values below are taken from Rhode Island TRM, 2020 Appendix A, table 3.

Table 15-5 Fixture Wattages By Type

Fixture Code	Description	Rated Watts
LED Exit Signs		
1E0002	2.0 WATT LED	2
1E0003	3.0 WATT LED	3
1E0005	5.0 WLED	5
1E0005C	0.5 WATT LEC	0.5
1E0008	8.0 WLED	8
1E0015	1.5 WATT LED	1.5
Compact Fluorescents		
1C0005S	5W COMPACT HW	7
1C0007S	7W COMPACT HW	9
1C0009S	9W COMPACT HW	11
1C0011S	11W COMPACT HW	13
1C0013S	13W COMPACT HW	15
1C0018E	18W COMPACT HW ELIG	20
1C0018S	18W COMPACT HW	20
1C0022S	22W COMPACT HW	24
1C0023E	1/23W COMPACT HW ELIG	25
1C0026E	26W COMPACT HW ELIG	28
1C0026S	26W COMPACT HW	28
1C0028S	28W COMPACT HW	30
1C0032E	32W COMPACT HW ELIG	34
1C0032S	32W CIRCLINE HW	34
1C0042E	1/42W COMPACT HW ELIG	48
1C0044S	44W CIRCLINE HW	46
1C0057E	1/57W COMPACT HW ELIG	65
2C0005S	2/5W COMPACT HW	14
2C0007S	2/7W COMPACT HW	18
2C0009S	2/9W COMPACT HW	22
2C0011S	2/11W COMPACT HW	26
2C0013E	2/13W COMPACT HW ELIG	28
2C0013S	2/13W COMPACT HW	30

Fixture Code	Description	Rated Watts
2C0018E	2/18W COMP. HW ELIG	40
2C0026E	2/26W COMP. HW ELIG	54
2C0032E	2/32W COMPACT HW ELIG	68
2C0042E	2/42W COMPACT HW ELIG	100
3C0009S	3/9W COMPACT HW	33
3C0013S	3/13W COMPACT HW	45
3C0018E	3/18W COMPACT HW ELIG	60
3C0026E	3/26W COMPACT HW ELIG	82
3C0032E	3/32W COMPACT HW ELIG	114
3C0042E	3/42W COMPACT HW ELIG	141
4C0013S	4/13W COMPACT HW	60
4C0018E	4/18W COMPACT HW ELIG	80
4C0026E	4/26W COMPACT HW ELIG	108
4C0032E	4/32W COMPACT HW ELIG	152
4C0042E	4/42W COMPACT HW ELIG	188
6C0026E	6/26W COMPACT HW ELIG	162
6C0032E	6/32W COMPACT HW ELIG	228
6C0042E	6/42W COMPACT HW ELIG	282
8C0026E	8/26W COMPACT HW ELIG	216
8C0032E	8/32W COMPACT HW ELIG	304
8C0042E	8/42W COMPACT HW ELIG	376
T5 Systems		
10F54HSE	10L4' 54W T5HO/ELIG	585
1F14SSE	1L2' 14W T5/ELIG	16
1F21SSE	1L3' 21W T5/ELIG	24
1F24HSE	1L2' 24W T5HO/ELIG	29
1F28SSE	1L4' 28W T5/ELIG	32
1F39HSE	1L3' 39W T5HO/ELIG	42
1F54HSE	1L4' 54W T5HO/ELIG	59
2F14SSE	2L2' 14W T5/ELIG	32
2F21SSE	2L3' 21W T5/ELIG	47

Fixture Code	Description	Rated Watts
2F24HSE	2L2' 24W T5HO/ELIG	52
2F28SSE	2L4' 28W T5/ELIG	63
2F39HSE	2L3' 39W T5HO/ELIG	85
2F54HSE	2L4' 54W T5HO/ELIG	117
3F24HSE	3L2' 24W T5HO/ELIG	80
3F28SSE	3L4' 28W T5 ELIG	95
3F54HSE	3L4' 54W T5HO/ELIG	177
4F54HSE	4L4' 54W T5HO/ELIG	234
5F54HSE	5L4' 54W T5HO/ELIG	294
6F54HSE	6L4' 54W T5HO/ELIG	351
8F54HSE	8L4' 54W T5HO/ELIG	468
Two Foot High Efficient T8 Systems		
1F17ESH	1L2' 17W T8EE/ELEE HIGH PWR	20
1F17ESL	1L2' 17W T8EE/ELEE LOW PWR	14
1F17ESN	1L2' 17W T8EE/ELEE	17
1F28BXE	1L2' F28BX/ELIG	32
2F17ESH	2L2' 17W T8EE/ELEE HIGH PWR	40
2F17ESL	2L2' 17W T8EE/ELEE LOW PWR	27
2F17ESN	2L2' 17W T8EE/ELEE	32
2F28BXE	2L2' F28BX/ELIG	63
3F17ESH	3L2' 17W T8EE/ELEE HIGH PWR	61
3F17ESL	3L2' 17W T8EE/ELEE LOW PWR	39
3F17ESN	3L2' 17W T8EE/ELEE	46
3F28BXE	3L2' F28BX/ELIG	94
Three Foot High Efficient T8 Systems		
1F25ESH	1L3' 25W T8EE/ELEE HIGH PWR	30
1F25ESL	1L3' 25W T8EE/ELEE LOW PWR	21
1F25ESN	1L3' 25W T8EE/ELEE	24
2F25ESH	2L3' 25W T8EE/ELEE HIGH PWR	60
2F25ESL	2L3' 25W T8EE/ELEE LOW PWR	40
2F25ESN	2L3' 25W T8EE/ELEE	45

Fixture Code	Description	Rated Watts
3F25ESH	3L3' 25W T8EE/ELEE HIGH PWR	90
3F25ESL	3L3' 25W T8EE/ELEE LOW PWR	58
3F25ESN	3L3' 25W T8EE/ELEE	67
Four Foot High Efficient T8 Systems		
1F25EEE	1L4' 25W T8EE/ELEE	22
1F25EEH	1L4' 25W T8EE/ELEE HIGH PWR	30
1F25EEL	1L4' 25W T8EE/ELEE LOW PWR	19
1F28EEE	1L4' 28W T8EE/ELEE	24
1F28EEH	1L4' 28W T8EE/ELEE HIGH PWR	33
1F28EEL	1L4' 28W T8EE/ELEE LOW PWR	22
1F30EEE	1L4' 30W T8EE/ELEE	26
1F30EEH	1L4' 30W T8EE/ELEE HIGH PWR	36
1F30EEL	1L4' 30W T8EE/ELEE LOW PWR	24
1F32EEE	1L4' 32W T8EE/ELEE	28
1F32EEH	1L4' 32W T8EE/ELEE HIGH PWR	38
1F32EEL	1L4' 32W T8EE/ELEE LOW PWR	25
2F25EEE	2L4' 25W T8EE/ELEE	43
2F25EEH	2L4' 25W T8EE/ELEE HIGH PWR	57
2F25EEL	2L4' 25W T8EE/ELEE LOW PWR	37
2F28EEE	2L4' 28W T8EE/ELEE	48
2F28EEH	2L4' 28WT8EE/ELEE HIGH PWR	64
2F28EEL	2L4' 28W T8EE/ELEE LOW PWR	42
2F30EEE	2L4' 30W T8EE/ELEE	52
2F30EEH	2L4' 30WT8EE/ELEE HIGH PWR	69
2F30EEL	2L4' 30W T8EE/ELEE LOW PWR	45
2F32EEE	2L4' 32W T8EE/ELEE	53
2F32EEH	2L4' 32W T8EE/ELEE HIGH PWR	73
2F32EEL	2L4' 32W T8EE/ELEE LOW PWR	47
3F25EEE	3L4' 25W T8EE/ELEE	64
3F25EEH	3L4' 25W T8EE/ELEE HIGH PWR	86
3F25EEL	3L4' 25W T8EE/ELEE LOW PWR	57

Fixture Code	Description	Rated Watts
3F28EEE	3L4' 28W T8EE/ELEE	72
3F28EEH	3L4' 28W T8EE/ELEE HIGH PWR	96
3F28EEL	3L4' 28W T8EE/ELEE LOW PWR	63
3F30EEE	3L4' 30W T8EE/ELEE	77
3F30EEH	3L4' 30W T8EE/ELEE HIGH PWR	103
3F30EEL	3L4' 30W T8EE/ELEE LOW PWR	68
3F32EEE	3L4' 32W T8EE/ELEE	82
3F32EEH	3L4' 32W T8EE/ELEE HIGH PWR	109
3F32EEL	3L4' 32W T8EE/ELEE LOW PWR	72
4F25EEE	4L4' 25W T8EE/ELEE	86
4F25EEH	4L4' 25W T8EE/ELEE HIGH PWR	111
4F25EEL	4L4' 25W T8EE/ELEE LOW PWR	75
4F28EEE	4L4' 28W T8EE/ELEE	94
4F28EEH	4L4' 28W T8EE/ELEE HIGH PWR	126
4F28EEL	4L4' 28W T8EE/ELEE LOW PWR	83
4F30EEE	4L4' 30W T8EE/ELEE	101
4F30EEH	4L4' 30W T8EE/ELEE HIGH PWR	133
4F30EEL	4L4' 30W T8EE/ELEE LOW PWR	89
4F32EEE	4L4' 32W T8EE/ELEE	107
4F32EEH	4L4' 32W T8EE/ELEE HIGH PWR	141
4F32EEL	4L4' 32W T8EE/ELEE LOW PWR	95
6F32EEE	6L4' 32W T8EE/ELEE	168
6F32EEH	6L4' 32W T8EE/ELEE HIGH PWR	218
6F32EEL	6L4' 32W T8EE/ELEE LOW PWR	146
Eight Foot T8 Systems		
1F59SSE	1L8' T8/ELIG	60
1F80SSE	1L8' T8 HO/ELIG	85
2F59SSE	2L8' T8/ELIG	109
2F59SSL	2L8' T8/ELIG LOW PWR	100
2F80SSE	2L8' T8 HO/ELIG	160
LED Lighting Fixtures		

Fixture Code	Description	Rated Watts
1E0002	2.0 WATT LED	2
1E0003	3.0 WATT LED	3
1E0015	1.5 WATT LED	1.5
1E0105	10.5 WATT LED	10.5
1L002	2 WATT LED	2
1L003	3 WATT LED	3
1L004	4 WATT LED	4
1L005	5 WATT LED	5
1L006	6 WATT LED	6
1L007	7 WATT LED	7
1L008	8 WATT LED	8
1L009	9 WATT LED	9
1L010	10 WATT LED	10
1L011	11 WATT LED	11
1L012	12 WATT LED	12
1L013	13 WATT LED	13
1L014	14 WATT LED	14
1L015	15 WATT LED	15
1L016	16 WATT LED	16
1L017	17 WATT LED	17
1L018	18 WATT LED	18
1L019	19 WATT LED	19
1L020	20 WATT LED	20
1L021	21 WATT LED	21
1L022	22 WATT LED	22
1L023	23 WATT LED	23
1L024	24 WATT LED	24
1L025	25 WATT LED	25
1L026	26 WATT LED	26
1L027	27 WATT LED	27
1L028	28 WATT LED	28

Fixture Code	Description	Rated Watts
1L029	29 WATT LED	29
1L030	30 WATT LED	30
1L031	31 WATT LED	31
1L032	32 WATT LED	32
1L033	33 WATT LED	33
1L034	34 WATT LED	34
1L035	35 WATT LED	35
1L036	36 WATT LED	36
1L037	37 WATT LED	37
1L038	38 WATT LED	38
1L039	39 WATT LED	39
1L040	40 WATT LED	40
1L041	41 WATT LED	41
1L042	42 WATT LED	42
1L043	43 WATT LED	43
1L044	44 WATT LED	44
1L045	45 WATT LED	45
1L046	46 WATT LED	46
1L047	47 WATT LED	47
1L048	48 WATT LED	48
1L049	49 WATT LED	49
1L050	50 WATT LED	50
1L051	51 WATT LED	51
1L052	52 WATT LED	52
1L053	53 WATT LED	53
1L054	54 WATT LED	54
1L055	55 WATT LED	55
1L056	56 WATT LED	56
1L057	57 WATT LED	57
1L058	58 WATT LED	58
1L059	59 WATT LED	59

Fixture Code	Description	Rated Watts
1L060	60 WATT LED	60
1L061	61 WATT LED	61
1L062	62 WATT LED	62
1L063	63 WATT LED	63
1L064	64 WATT LED	64
1L065	65 WATT LED	65
1L066	66 WATT LED	66
1L067	67 WATT LED	67
1L068	68 WATT LED	68
1L069	69 WATT LED	69
1L070	70 WATT LED	70
1L071	71 WATT LED	71
1L072	72 WATT LED	72
1L073	73 WATT LED	73
1L074	74 WATT LED	74
1L075	75 WATT LED	75
1L076	76 WATT LED	76
1L077	77 WATT LED	77
1L078	78 WATT LED	78
1L079	79 WATT LED	79
1L080	80 WATT LED	80
1L081	81 WATT LED	81
1L082	82 WATT LED	82
1L083	83 WATT LED	83
1L084	84 WATT LED	84
1L085	85 WATT LED	85
1L086	86 WATT LED	86
1L087	87 WATT LED	87
1L088	88 WATT LED	88
1L089	89 WATT LED	89
1L090	90 WATT LED	90

Fixture Code	Description	Rated Watts
1L091	91 WATT LED	91
1L092	92 WATT LED	92
1L093	93 WATT LED	93
1L094	94 WATT LED	94
1L095	95 WATT LED	95
1L096	96 WATT LED	96
1L097	97 WATT LED	97
1L098	98 WATT LED	98
1L099	99 WATT LED	99
1L100	100 WATT LED	100
1L110	110 WATT LED	110
1L116	116 WATT LED	116
1L120	120 WATT LED	120
1L125	125 WATT LED	125
1L130	130 WATT LED	130
1L135	135 WATT LED	135
1L140	140 WATT LED	140
1L145	145 WATT LED	145
1L150	150 WATT LED	150
1L155	155 WATT LED	155
1L160	160 WATT LED	160
1L165	165 WATT LED	165
1L170	170 WATT LED	170
1L175	175 WATT LED	175
1L180	180 WATT LED	180
1L185	185 WATT LED	185
1L190	190 WATT LED	190
1L200	200 WATT LED	200
1L210	210 WATT LED	210
1L220	220 WATT LED	220
1L240	240 WATT LED	240

Fixture Code	Description	Rated Watts
1L376	4X94 WATT LED	376
1L405	3x135 WATT LED	405
Electronic Metal Halide Lamps		
1M0150E	150W METAL HALIDE EB	160
1M0200E	200W METAL HALIDE EB	215
1M0250E	250W METAL HALIDE EB	270
1M0320E	320W METAL HALIDE EB	345
1M0350E	350W METAL HALIDE EB	375
1M0400E	400W METAL HALIDE EB	430
1M0450E	400W METAL HALIDE EB	480
MH Track Lighting		
1M0020E	20W MH SPOT	25
1M0025E	25W MH SPOT	25
1M0035E	35W MH SPOT	44
1M0039E	39W MH SPOT	47
1M0050E	50W MH SPOT	60
1M0070E	70W MH SPOT	80
1M0100E	100W MH SPOT	111
1M0150E	150W MH SPOT	162
Incandescent Lamps		
1I0015	15W INC	15
1I0020	20W INC	20
1I0025	25W INC	25
1I0034	34W INC	34
1I0036	36W INC	36
1I0040	40W INC	40
1I0042	42W INC	42
1I0045	45W INC	45
1I0050	50W INC	50
1I0052	52W INC	52
1I0054	54W INC	54

Fixture Code	Description	Rated Watts
110055	55W INC	55
110060	60W INC	60
110065	65W INC	65
110067	67W INC	67
110069	69W INC	69
110072	72W INC	72
110075	75W INC	75
110080	80W INC	80
110085	85W INC	85
110090	90W INC	90
110093	93W INC	93
110100	100W INC	100
110120	120W INC	120
110125	125W INC	125
110135	135W INC	135
110150	150W INC	150
110200	200W INC	200
110300	300W INC	300
110448	448W INC	448
110500	500W INC	500
110750	750W INC	750
111000	1000W INC	1000
111500	1500W INC	1500
Low Voltage Halogen Fixture (includes Transformer)		
1R0020	20W LV HALOGEN FIXT	30
1R0025	25W LV HALOGEN FIXT	35
1R0035	35W LV HALOGEN FIXT	45
1R0042	42W LV HALOGEN FIXT	52
1R0050	50W LV HALOGEN FIXT	60
1R0065	65W LV HALOGEN FIXT	75
1R0075	75W LV HALOGEN FIXT	85

Fixture Code	Description	Rated Watts
Halogen/Quartz Lamps		
1T0035	35W HALOGEN LAMP	35
1T0040	40W HALOGEN LAMP	40
1T0042	42W HALOGEN LAMP	42
1T0045	45W HALOGEN LAMP	45
1T0047	47W HALOGEN LAMP	47
1T0050	50W HALOGEN LAMP	50
1T0052	52W HALOGEN LAMP	52
1T0055	55W HALOGEN LAMP	55
1T0060	60W HALOGEN LAMP	60
1T0072	72W HALOGEN LAMP	72
1T0075	75W HALOGEN LAMP	75
1T0090	90W HALOGEN LAMP	90
1T0100	100W HALOGEN LAMP	100
1T0150	150W HALOGEN LAMP	150
1T0200	200W HALOGEN LAMP	200
1T0250	250W HALOGEN LAMP	250
1T0300	300W HALOGEN LAMP	300
1T0350	350W HALOGEN LAMP	350
1T0400	400W HALOGEN LAMP	400
1T0425	425W HALOGEN LAMP	425
1T0500	500W HALOGEN LAMP	500
1T0750	750W HALOGEN LAMP	750
1T0900	900W HALOGEN LAMP	900
1T1000	1000W HALOGEN LAMP	1000
1T1200	1200W HALOGEN LAMP	1200
1T1500	1500W HALOGEN LAMP	1500
2T0075	2-75W HALOGEN LAMP	1800
Mercury Vapor (MV)		
1V0040S	40W MERCURY	50
1V0050S	50W MERCURY	75

Fixture Code	Description	Rated Watts
1V0075S	75W MERCURY	95
1V0100S	100W MERCURY	120
1V0175S	175W MERCURY	205
1V0250S	250W MERCURY	290
1V0400S	400W MERCURY	455
1V0700S	700W MERCURY	775
1V1000S	1000W MERCURY	1075
2V0400S	2/400W MERCURY	880
Low Pressure Sodium (LPS)		
1L0035S	35W LPS	60
1L0055S	55W LPS	85
1L0090S	90W LPS	130
1L0135S	135W LPS	180
1L0180S	180W LPS	230
High Pressure Sodium (HPS)		
1H0035S	35W HPS	45
1H0050S	50W HPS	65
1H0070S	70W HPS	90
1H0100S	100W HPS	130
1H0150S	150W HPS	190
1H0200S	200W HPS	240
1H0225S	225W HPS	275
1H0250S	250W HPS	295
1H0310S	310W HPS	350
1H0360S	360W HPS	435
1H0400S	400W HPS	460
1H0600S	600W HPS	675
1H0750S	750W HPS	835
1H1000S	1000W HPS	1085
Metal Halide (MH)		
1M0032S	32W METAL HALIDE	40

Fixture Code	Description	Rated Watts
1M0050S	50W METAL HALIDE	65
1M0070S	70W METAL HALIDE	95
1M0100S	100W METAL HALIDE	120
1M0150E	150W METAL HALIDE EB	160
1M0150S	150W METAL HALIDE	190
1M0175S	175W METAL HALIDE	205
1M0200E	200W METAL HALIDE EB	215
1M0250E	250W METAL HALIDE EB	270
1M0250S	250W METAL HALIDE	295
1M0320E	320W METAL HALIDE EB	345
1M0350E	350W METAL HALIDE EB	375
1M0360S	360W METAL HALIDE	430
1M0400E	400W METAL HALIDE EB	430
1M0400S	400W METAL HALIDE	455
1M0450E	400W METAL HALIDE EB	480
1M0750S	750W METAL HALIDE	825
1M1000S	1000W METAL HALIDE	1075
1M1500S	1500W METAL HALIDE	1615
1M1800S	1800W METAL HALIDE	1875
Pulse Start Metal Halide Lamp/Ballast		
1M0100P	100W MH CWA	128
1M0100R	100W MH LINEAR	118
1M0150P	150W MH CWA	190
1M0150R	150W MH LINEAR	172
1M0175P	175W MH CWA	208
1M0175R	175W MH LINEAR	190
1M0200P	200W MH CWA	232
1M0200R	200W MH LINEAR	218
1M0250P	250W MH CWA	288
1M0250R	250W MH LINEAR	265
1M0300P	300W MH CWA	342

Fixture Code	Description	Rated Watts
1M0300R	300W MH LINEAR	324
1M0320P	320W MH CWA	365
1M0320R	320W MH LINEAR	345
1M0350P	350W MH CWA	400
1M0350R	350W MH LINEAR	375
1M0400P	400W MH CWA	455
1M0400R	400W MH LINEAR	430
1M0450P	450W MH CWA	508
1M0450R	450W MH LINEAR	480
1M0750P	750W MH CWA	815
1M0750R	750W MH LINEAR	805
1M1000P	1000W MH CWA	1080
Two Foot T8/T12 Systems		
12F40BE	12L2' F40BX/ELIG	408
12F50BE	12L2' F50BX/ELIG	648
12F55BE	12L2' F55BX/ELIG	672
1F55BXE	1L2' F55BX/ELIG	56
1F80BXE	1L2' F80BXE/ELIG	90
2F17SSE	2L2' 17W T8/ELIG	37
2F17SSL	2L2' 17W T8/ELIG LOW POWER	27
2F17SSM	2L2' 17W T8/EEMAG	45
2F24HSS	2L2' 24 T12HO/STD/STD	85
2F40BXE	2L2' F40BX/ELIG	72
2F50BXE	2L2' F50BX/ELIG	108
2F55BXE	2L2'55BXE/ELIG	112
3F17SSE	3L2' 17W T8/ELIG	53
3F17SSL	3L2' 17W T8/ELIG LOW POWER	39
3F40BXE	3L2' F40BX/ELIG	102
3F50BXE	3L2' F50BX/ELIG	162
3F55BXE	3L2' F55BX/ELIG	168
4F17SSE	4L2' 17W T8/ELIG	62

Fixture Code	Description	Rated Watts
4F36BXE	4L2' F36BX/ELIG	148
4F40BXE	4L2' F40BX/ELIG	144
4F50BXE	4L2' F50BX/ELIG	216
4F55BXE	4L2' F55BX/ELIG	224
5F40BXE	5L2' F40BX/ELIG	190
5F50BXE	5L2' F50BX/ELIG	270
5F55BXE	5L2' F55BX/ELIG	280
6F36BXE	6L2' F36BX/ELIG	212
6F40BXE	6L2' F40BX/ELIG	204
6F50BXE	6L2' F50BX/ELIG	324
6F55BXE	6L2' F55BX/ELIG	336
8F36BXE	8L2' F36BX/ELIG	296
8F40BXE	8L2' F40BX/ELIG	288
8F50BXE	8L2' F50BX/ELIG	432
8F55BXE	8L2' F55BX/ELIG	448
9F36BXE	9L2' F36BX/ELIG	318
9F40BXE	9L2' F40BX/ELIG	306
9F50BXE	9L2' F50BX/ELIG	486
9F55BXE	9L2' F55BX/ELIG	504
Three Foot T8/T12 Systems		
1F25SSE	1L3' 25W T8/ELIG	24
1F30SEM	1L3' 30W T12 EE/EEMAG	38
1F30SES	1L3' 30W T12 EE/STD	42
1F30SSS	1L3' 30W T12 STD/STD	46
2F25SSE	2L3' 25W T8/ELIG	47
2F25SSM	2L3' 25W T8/EEMAG	65
2F30SEE	2L3' 30W T12 EE/ELIG	49
2F30SEM	2L3' 30W T12 EE/EEMAG	66
2F30SES	2L3' 30W T12 EE/STD	73
2F30SSS	2L3' 30W T12 STD/STD	80
3F25SSE	3L3' 25W T8/ELIG	68

Fixture Code	Description	Rated Watts
3F30SES	3L3' 30W T12 EE/STD	127
3F30SSS	3L3' 30W T12 STD/STD	140
4F25SSE	4L3' 25W T8/ELIG	88
Four Foot F48		
1F48HES	1L4' F48HO/EE/STD	80
1F48HSS	1L4' F48HO/STD/STD	85
1F48SES	1L4' F48T12EE/STD	50
1F48SSS	1L4' F48T12/STD	60
1F48VES	1L4' F48VHO/EE/STD	123
1F48VSS	1L4' F48VHO/STD/STD	138
2F48HES	2L4' F48HO/EE/STD	135
2F48HSS	2L4' F48HO/STD/STD	145
2F48SES	2L4' F48T12EE/STD	82
2F48SSS	2L4' F48T12/STD	102
2F48VES	2L4' F48VHO/EE/STD	210
2F48VSS	2L4' F48VHO/STD/STD	240
3F48HES	3L4' F48HO/EE/STD	215
3F48HSS	3L4' F48HO/STD/STD	230
3F48SES	3L4' F48T12EE/STD	132
3F48SSS	3L4' F48T12/STD	162
3F48VES	3L4' F48VHO/EE/STD	333
3F48VSS	3L4' F48VHO/STD/STD	378
4F48HES	4L4' F48HO/EE/STD	270
4F48HSS	4L4' F48HO/STD/STD	290
4F48SES	4L4' F48T12EE/STD	164
4F48SSS	4L4' F48T12/STD	204
4F48VES	4L4' F48VHO/EE/STD	420
4F48VSS	4L4' F48VHO/STD/STD	480
Four Foot T12 Systems		
1F40SEE	1L4' EE/ELIG	38
1F40SEM	1L4' EE/EEMAG	40

Fixture Code	Description	Rated Watts
1F40SES	1L4' EE/STD	50
1F40SSE	1L4' STD/ELIG	46
1F40SSM	1L4' STD/EEMAG	50
1F40SSS	1L4' STD/STD	57
1F48SES	1L4' F48T12EE/STD	50
1F48SSS	1L4' F48T12/STD	60
2F40SEE	2L4' EE/ELIG	60
2F40SEM	2L4' EE/EEMAG	70
2F40SES	2L4' EE/STD	80
2F40SSE	2L4' STD/ELIG	72
2F40SSM	2L4' STD/EEMAG	86
2F40SSS	2L4' STD/STD	94
2F48SES	2L4' F48T12EE/STD	82
2F48SSS	2L4' F48T12/STD	102
3F40SEE	3L4' EE/ELIG	90
3F40SEM	3L4' EE/EEMAG	110
3F40SES	3L4' EE/STD	130
3F40SSE	3L4' STD/ELIG	110
3F40SSM	3L4' STD/EEMAG	136
3F40SSS	3L4' STD/STD	151
3F48SES	3L4' F48T12EE/STD	132
3F48SSS	3L4' F48T12/STD	162
4F40SEE	4L4' EE/ELIG	120
4F40SEM	4L4' EE/EEMAG	140
4F40SES	4L4' EE/STD	160
4F40SSE	4L4' STD/ELIG	144
4F40SSM	4L4' STD/EEMAG	172
4F40SSS	4L4' STD/STD	188
4F48SES	4L4' F48T12EE/STD	164
4F48SSS	4L4' F48T12/STD	204
6F40SSS	6L4' STD/STD	282

Fixture Code	Description	Rated Watts
Four Foot T8 Systems		
1F32SSE	1L4' T8/ELIG	30
1F32SSL	1L4 T8/ELIG LOW POWER	26
1F32SSM	1L4' T8/EEMAG	37
2F32SSE	2L4' T8/ELIG	60
2F32SSH	2L4' T8/ELIG HIGH LMN	78
2F32SSL	2L4 T8/ELIG LOW PWR	52
2F32SSM	2L4' T8/EEMAG	70
3F32SSE	3L4' T8/ELIG	88
3F32SSH	3L4' T8/ELIG HIGH LMN	112
3F32SSL	3L4 T8/ELIG LOW POWER	76
3F32SSM	3L4' T8/EEMAG	107
4F32SSE	4L4' T8/ELIG	112
4F32SSH	4L4' T8/ELIG HIGH LMN	156
4F32SSL	4L4 T8/ELIG LOW PWR	98
4F32SSM	4L4' T8/EEMAG	140
5F32SSE	5L4' T8/ELIG	148
5F32SSH	5L4' T8/ELIG HIGH LMN	190
6F32SSE	6L4' T8/ELIG	174
8F32SSH	8L4' T8/ELIG HIGH LMN	312
Five Foot T8/T12 Systems		
1F40HSE	1L5' HO/STD/ELIG	59
1F60HSM	1L5' HO/STD/EEMAG	90
1F60SSM	1L5'/STD/EEMAG	73
1F60TSM	1L5' T10HO/STD/EEMAG	135
2F40HSE	2L5' HO/STD/ELIG	123
2F40TSE	2L5'T8/ELIG	68
2F60HSM	2L5' HO/STD/EEMAG	178
2F60SSM	2L5'/STD/EEMAG	122
3F40TSE	3L5'T8/ELIG	106
Six Foot T12 and T12HO Systems		

Fixture Code	Description	Rated Watts
1F72HSE	1L6' T8HO/ELIG	80
1F72HSS	1L6' F72HO/STD/STD	113
1F72SSM	1L6' STD/EEMAG	80
1F72SSS	1L6' STD/STD	95
2F72HSE	2L6'T8 HO/ELIG	160
2F72HSM	2L6' F72HO/STD/EEMAG	193
2F72HSS	2L6' F72HO/STD	195
2F72SSM	2L6' STD/EEMAG	135
2F72SSS	2L6' STD/STD	173
Eight Foot T12VHO Systems		
1F96VES	1L8' VHO/EE/STD	200
1F96VSS	1L8' VHO/STD/STD	230
2F96VES	2L8' VHO/EE/STD	390
2F96VSS	2L8' VHO/STD/STD	450
3F96VES	3L8' VHO/EE/STD	590
3F96VSS	3L8' VHO/STD/STD	680
4F96VES	4L8' VHO/EE/STD	780
4F96VSS	4L8' VHO/STD/STD	900
Eight Foot T8 System		
1F59SSE	1L8' T8/ELIG	60
1F80SSE	1L8' T8 HO/ELIG	85
2F59SSE	2L8' T8/ELIG	109
2F59SSL	2L8' T8/ELIG LOW PWR	100
2F80SSE	2L8' T8 HO/ELIG	160
Eight Foot T12 System		
1F96SEE	1L8' EE/ELIG	60
1F96SES	1L8' EE/STD	83
1F96SSE	1L8' STD/ELIG	70
1F96SSS	1L8' STD/STD	100
2F96SEE	2L8' EE/ELIG	109
2F96SEM	2L8' EE/EEMAG	123

Fixture Code	Description	Rated Watts
2F96SES	2L8' EE/STD	138
2F96SSE	2L8' STD/ELIG	134
2F96SSM	2L8' STD/EEMAG	158
2F96SSS	2L8' STD/STD	173
3F96SES	3L8' EE/STD	221
3F96SSS	3L8' STD/STD	273
4F96SEE	4L8' EE/ELIG	218
4F96SEM	4L8' EE/EEMAG	246
4F96SES	4L8' EE/STD	276
4F96SSE	4L8' STD/ELIG	268
4F96SSM	4L8' STD/EEMAG	316
4F96SSS	4L8' STD/STD	346